

**63/2023**



**CATALOGUE**  

---

**2023**



Roller cabinets  
**Page 186**



Accessories range  
for 516 and 519 roller cabinets  
**Page 194-200**



Work benches  
**Page 181**



Cabinets  
**Page 195**



Workshop furniture  
**Page 182**



Maintenance suitcases  
**Page 28**



Assortments  
**Page 163**

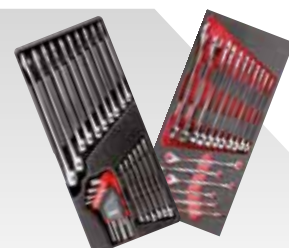

Modules for roller cabinets  
**Page 202**



Bags and cases  
**Page 29**



Cases for tools  
**Page 255**



Wrenches  
**Page 90-110**



Sockets  
**Page 69**



Impact sockets  
**Page 70**



Assortments of sockets  
**Page 233**



Torque  
**Page 265**



Screwdrivers  
**Page 130**



Hexagon keys  
**Page 98**



Bits  
**Page 256**



Pliers and cutting nippers  
**Page 50**



Hammers  
**Page 144**



**Cancelled and  
replaced products**

**Page  
344**

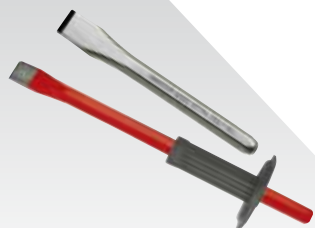

**Chisels  
Page 142**



**Hacksaws and scissors  
Page 65**

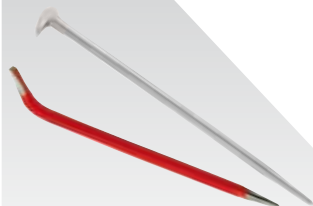

**Levers  
Page 150**



**Riveters  
Page 290**



**Pullers  
Page 156**



**Measuring and  
marking out  
Page 283**



**Hydraulics  
Page 125**



**1000V insulated tools  
Page 41**



**Scissors for electricians  
Page 67**



**Electrotechnics  
Page 55**



**Lighting  
Page 272**



**Automotive  
Page 94**



**Timing  
Page 291**



**Airtools  
Page 277**



**Matrix  
Page 298**



**RMD  
Page 320**



**Griffe  
Page 338**



**Shoes  
Page 297**



**Display stands  
Page 322**



**Counter display stands  
Page 327**

# The company

## StanleyBlack&Decker

We are part of the multinational group StanleyBlack&Decker, the world's leading tool manufacturer group.

Our mission is to serve our clients in the best possible manner, both in the Automotive (vehicle repairs) and Industry sectors, in the handicraft and manufacturing compartment.

USAG's values are innovation, quality and customer satisfaction. Being part of StanleyBlack&Decker enables us to keep these values alive, thanks to the group's resources and competencies.



Gemonio and Monvalle sites, have obtained the OHSAS 18001:2007 and ISO 14001:2015 certifications that guarantee the evaluation and reduction of risks for safety and its environmental impact and commitment to the continuous improvement. They are also SA 8000 certified (Social Responsibility), a standard recognized at an international level that ensures that the products/services have origin, are manufactured and distributed in compliance with the human rights at work, both internally and throughout the whole supply chain. The production site of Gemonio is also certified according to ISO 9001: 2015, which guarantees high quality standards for products and processes.

**At Stanley Black & Decker we're working towards being ECOSMART™.** This means that we are committed to improving the sustainability of our operations, our products, our communities, our suppliers and our customers. Moreover, it means that we are vigilant about our sustainability initiatives, and place a priority on maintaining an open dialogue with all of our stakeholders.

The **Distribution Center** of Monvalle (VA) ships USAG products in Italy and in all countries of the world, from Chile to Japan.

It consists of three main souls:

- The fully automated high-tech vertical warehouse, with multiple pickers operating at the same time, able to optimize the picking of slow rotation products.
- The horizontal warehouse with manual picking, reserved to high rotation products.
- The area dedicated to the packaging of assortments and kits of tools.

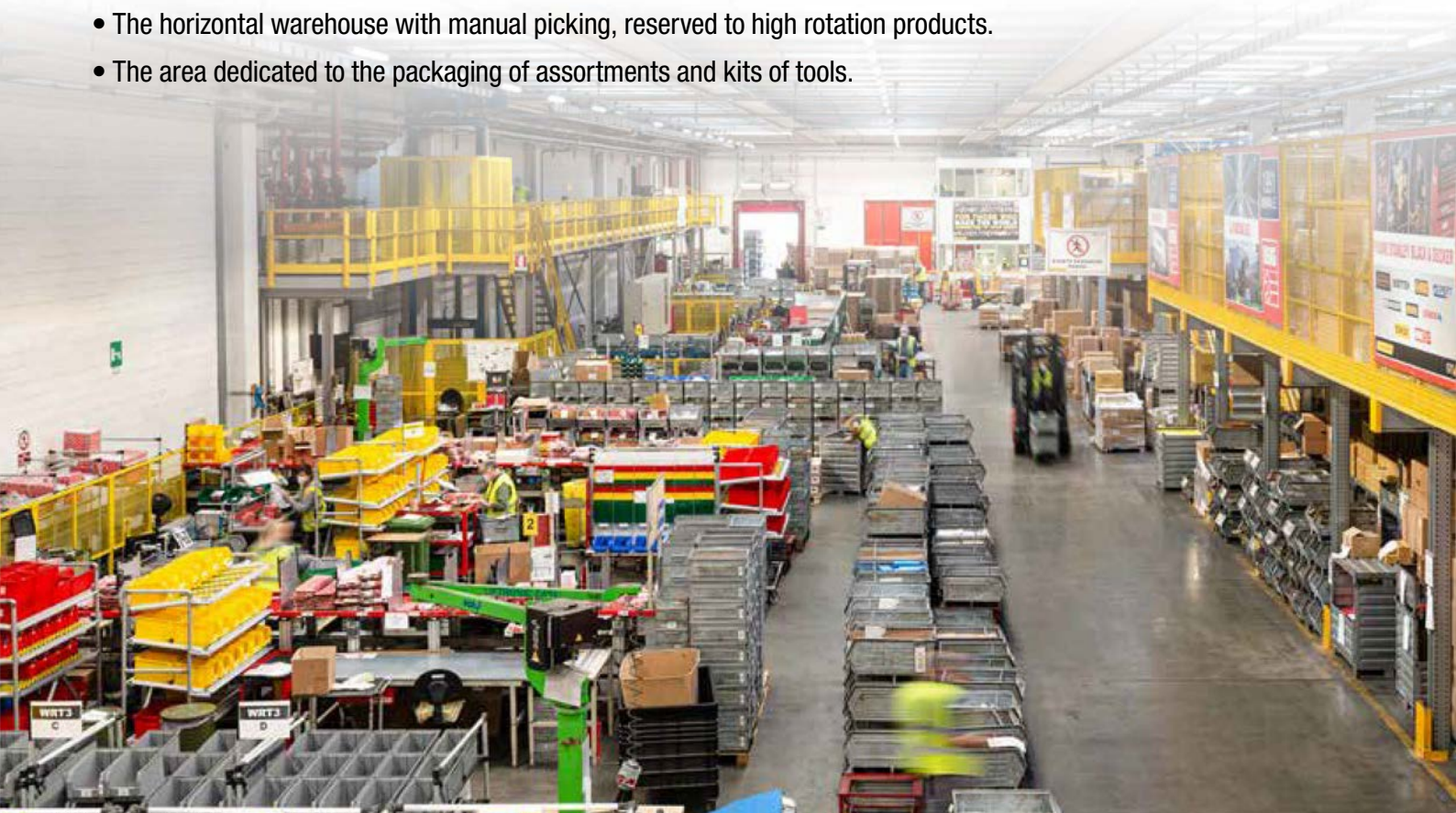

**36.000**

storage spaces  
managed

**4.250**

packages shipped  
per week

**3.500**

order lines  
processed per day

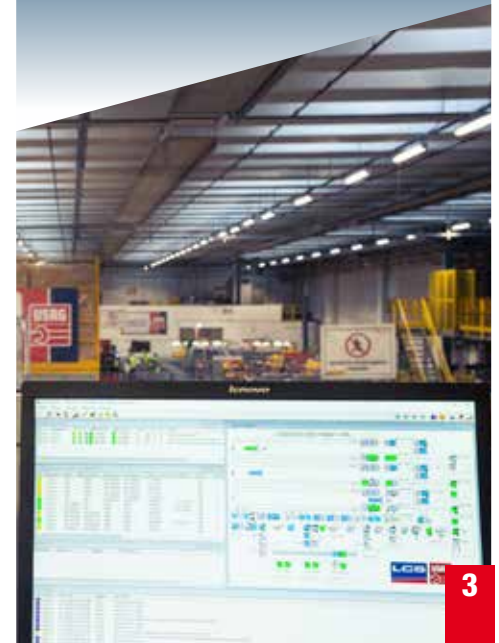

## CUSTOMIZED TRAINING

### StanleyBlack&Decker

#### Training Centre - Italy

USAG offers qualified training courses, in dedicated facilities or directly at customers' premises. The Stanley Black & Decker Training Center, located in our headquarters in Monvalle (VA), is available for the training of salespeople and counter agents.



## CUSTOMIZED PRODUCTS

USAG offers the possibility to realize customized products with customer logo or in specific colors and sockets and bits with special sizes.



# YOUR AFTER-SALES CONTACTS

***www.2helpu.com/USAG***

- spare parts
- instructions for use

***service.italia@sbdinc.com***

- After-sales assistance
- Requests for repair
- Information





# USAG

## GUARANTEED TOOLS

The USAG Guarantee is an integral part of our commitment to customers and ensures full satisfaction in the use of our professional tools, manufactured with the best raw materials and the most modern production techniques.

USAG tools are warranted for manufacturing defects and material defects: improper use, normal wear and tear, are excluded from the warranty.

To manage and follow the returned products, we have developed a dedicated organization that responds promptly and professionally to customer needs.

### Information and details organized by product category



Hand  
tools



Socket  
wrenches



Airtools



Service  
jacks



Torque  
tools



Containers  
for tools



Automotive

**DOWNLOAD THE COMPLETE DOCUMENT ON:**  
**[usag-tools.net](http://usag-tools.net)**



## TORQUE TOOLS CALIBRATION SERVICE

Guaranteed in compliance with the UNI EN rules ISO 6789-2: 2017 and through an Accredited Laboratory (LAT).



### PRODUCTS FOR WHICH REQUEST IS FORESEEN

- Mechanical torque wrenches (disengagement, click, slip, direct reading and non graduated).
- Digital torque wrenches.
- Torque screwdrivers.
- Digital torque meters.



### AVAILABLE CERTIFICATES

- Standard calibration certificate (torque) Right hand, left hand or both.
- Accredia calibration certificate (torque) Right hand, left hand or both.
- Angular tightening calibration certificate.
- Torque calibration certificate (torque) Right hand, left hand or both.

**FAST MANAGEMENT TIMES. CLEAR PRICES.**

Contact your USAG dealer.

# POINT OF SALES DISPLAYS



Display stands, totems and accessories to create effective layouts in your point of sale. Innovative solutions to customize areas dedicated to the most important product lines.

## PRODUCT INFORMATION

Our products have unique technical characteristics: highlight them using USAG magnetic supports. Available a kit with 15 magnetic product cards or the universal support also suitable for highlighting promotions.



# COUNTER DISPLAYS

A wide range of more than 30 cardboard counter displays, useful to push the sale of high rotation products.

## PLIERS



## SCISSORS



## HEXAGONAL KEYS



## TIGHTENING



**MORE THAN 30 COUNTER DISPLAY STANDS AVAILABLE!**

## GROUND DISPLAYS

Pallbox with sets of screwdrivers or specific kits with other products. Ideal for creating a promotional island in the store.

Just order the dedicated code and you will receive the exhibitor complete with products and ready for use.



## Customized roller cabinets

Choose from 184 different RAL colors



2 color combinations max



*This image is purely representative*

Choose the number of drawers



Add your logo



### We offer:

- A wide selection of roller cabinets, that meets all the needs of professional workers.
- The opportunity to customize the roller cabinets in the colors you prefer with the logo of your company.

**ALL USAG RANGE IS CUSTOMIZABLE!**



Send your request to:  
[prodotti.speciali@mygts.net](mailto:prodotti.speciali@mygts.net)

## Customized soft bags



### We offer:

- A wide selection of fabric soft bags, specifically designed for all the needs of craftsmen.
- The opportunity to customize soft bags with your logo (embroidered).



**ALL USAG RANGE  
IS CUSTOMIZABLE!**

Send your request to:  
[prodotti.speciali@mygts.net](mailto:prodotti.speciali@mygts.net)



## USAG WEBSITE AND APP

On **usag-tools.net** you will find the catalog always updated, product news and the best promotions of the moment.  
With the APP, you always have the complete catalogue with you even offline!

## SOCIAL

USAG Social channels have established themselves as a reference point for craftsmen and professionals of all trades as well as for small and medium industries.  
Video tutorials and product news are the main contents you can find on YouTube.



## PLANNERS

### [matrixgb.usag.it](http://matrixgb.usag.it)

With the **online configurator for commercial vehicles** you can create in complete autonomy the ideal lay-out for your van by choosing from a wide range of MATRIX items.



### [kitplanner-gb.usag.it](http://kitplanner-gb.usag.it)

**Kit Planner is an online configurator**, which helps you to create the assortment of tools that best suit your work needs, choosing among endless combinations and more than 120 job-specific assortments!



### [start516-gb.usag.it](http://start516-gb.usag.it)

The new **online configurator** of the **START 516 furniture line** allows you to create a tailor-made project to furnish your workshop with drawer chests, cabinets and workbenches, optimizing the workspaces.



### [fototeca.usag.it](http://fototeca.usag.it)

A complete archive of all USAG product photos, both in high and low resolution. Creating brochures, leaflets, catalogs or websites has never been easier.

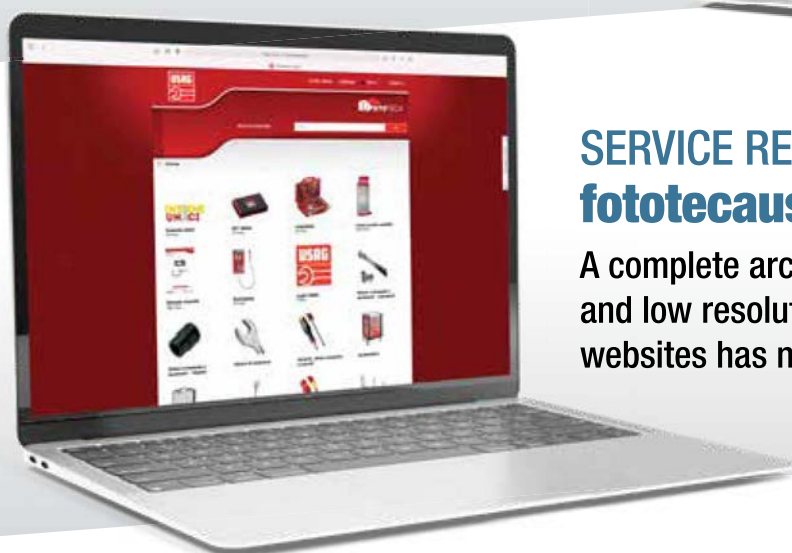



## WHAT ARE ICONIC PRODUCTS?

**Iconic Products** are **unique** products on the market that stand out for their **design, functionality** and **performance**. They are the **top-of-the-range** and **best performing** products you can find within the USAG offer and which, more than others, represent our prestigious brand.

Choosing an **Iconic Product** means choosing **quality** and **excellence**.  
*You, who are a professional, deserve the best tools on the market!*

## UNIQUE PRODUCTS ON THE MARKET FOR:

✓ DESIGN

✓ FUNCTIONALITY

✓ PERFORMANCES



324

150 AX

280 T

285

285 KA

237 A

207 E

443 N

## ONLY USAG CAN OFFER THEM!



## 324 SCREWDRIVERS

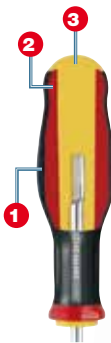

### THREE-MATERIAL GRIP

Outside part in polyurethane resistant to oils and chemicals Body in polyamide resistant to the efforts. Inside part in high density polyamide for perfect coupling with the blade.

### SOFT GRIP COATING

Better comfort during the use. Greater transmission of the torque.

### REINFORCED BLADE

Chrome Silicon Vanadium steel that allows the best mechanical resistance.

### TOP PERFORMANCE TIP

Zinc finish. Perfect shape. Treatment against corrosion.

### ANTI-ROLLING SHAPE

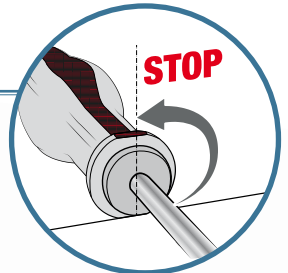

PAGE  
**133**

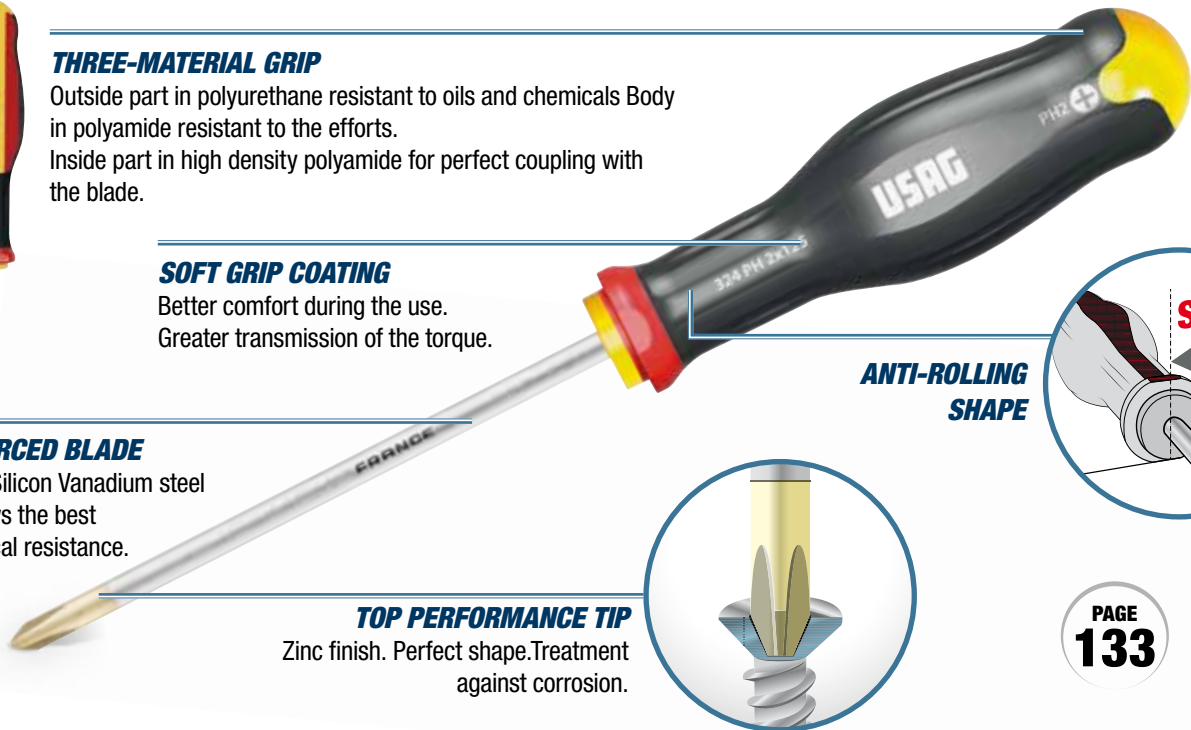

## 237 A

### REVERSIBLE RATCHET WITH SEALED MECHANISM IP51

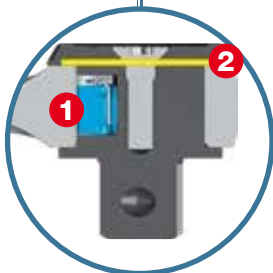
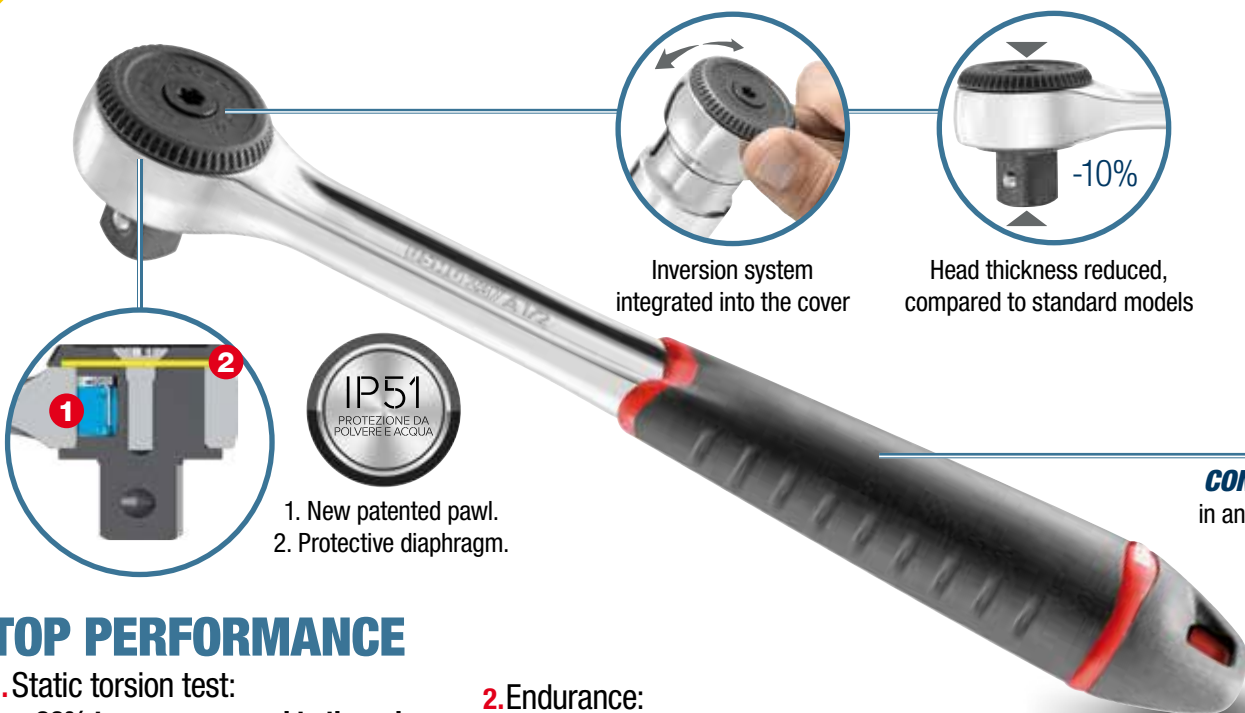

1. New patented pawl.  
2. Protective diaphragm.



Inversion system integrated into the cover



Head thickness reduced, compared to standard models



YouTube

PAGE  
**83**

**CONICAL HANDLE**  
in anti-slip bimaterial.

### TOP PERFORMANCE

1. Static torsion test:  
+ 30% torque compared to the value required by ISO rules 3315 because of the patented pawl.
2. Endurance:  
lasts twice than the other ratchets on the market because of IP51 protection.

## 285 Combination wrench

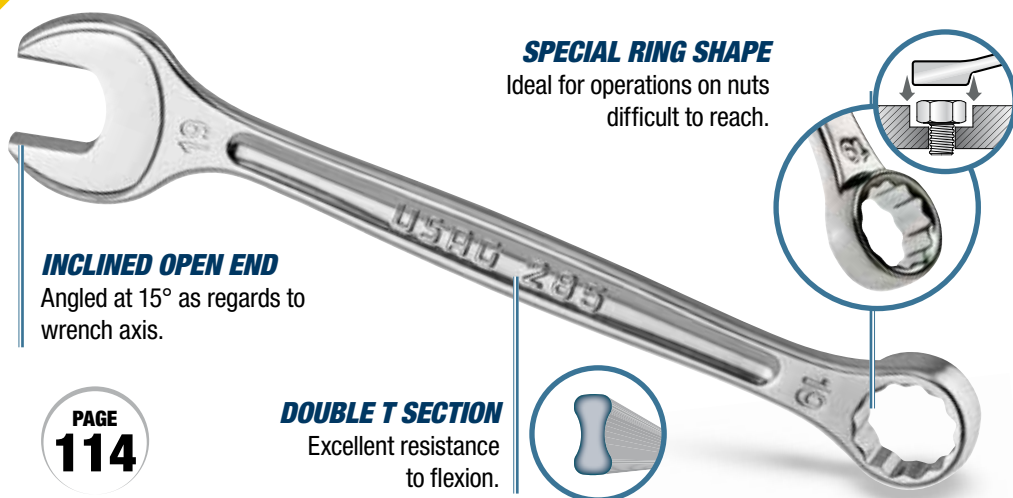

**SPECIAL RING SHAPE**  
Ideal for operations on nuts difficult to reach.

**INCLINED OPEN END**  
Angled at 15° as regards to wrench axis.

**DOUBLE T SECTION**  
Excellent resistance to flexion.



### TOP PERFORMANCE

Resistance to static torsion of ring and open end: **+ 50% respect to ISO rules 1711-1.**

PAGE  
**114**

## 280 T T-keys with hexagonal male



**SPECIAL CHROME VANADIUM STEEL**

**FIX BAR**  
Maximum resistance.



**USAG KEY**



**OTHER KEYS**

### GUARANTEED SAFETY

- + 30% resistance to torsion compared to ISO 2936 rules
- When the breaking torque is reached, the key will deform without breaking.

PAGE  
**106**

## 207 E Professional scissors for electricians



**THE ONLY ONE WITH INTEGRAL STAINLESS STEEL STRUCTURE**  
Flexural strenght 180 Kg.

**CUTTING CAPACITY**  
up to 50 mm<sup>2</sup>



### BUILT-IN WIRE STRIPPER

1. Stripping.
2. Crimping.



### CABLE CUTTER ON BOTH BLADES

Suitable for multi-core cables.



### MICRO ANTI-SLIP TOOTHING



PAGE  
**67**

## 285 KA Reversible ratchet combination wrenches with locking ring

PAGE 116

**PIANO WIRE STEEL RING INTEGRATED INTO THE BIHEXAGONAL EYE**

Keeps the position on the nut during the operations.

**OPTIMAL POSITION**



YouTube

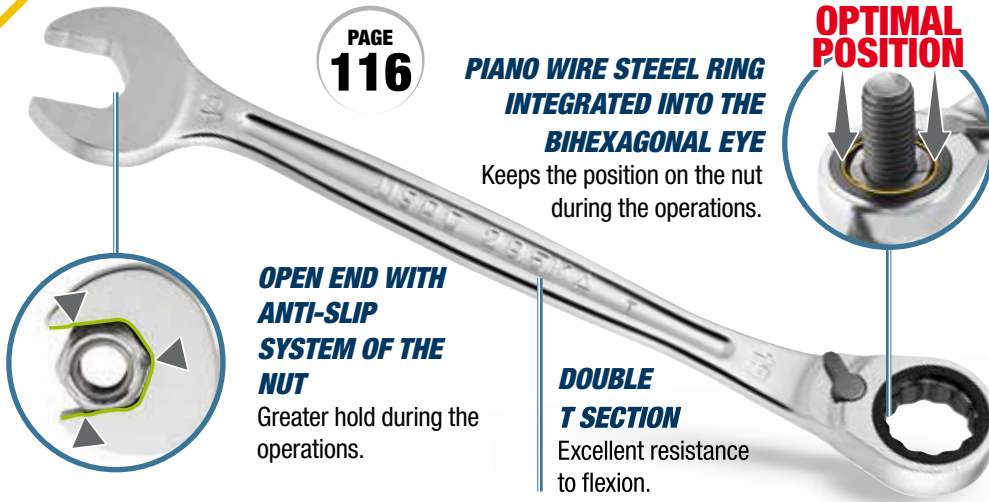

**OPEN END WITH ANTI-SLIP SYSTEM OF THE NUT**

Greater hold during the operations.

**DOUBLE T SECTION**

Excellent resistance to flexion.

**STRONG RATCHET**

Resistance to static torsion of the ratchet: **+50% compared to the value required by ISO rules 1711-1.**

## 150 AX Combination pliers



Can cut up to 2 mm piano wire with 30% less effort

in comparison to the maximum value stated on the European rules ISO5749 (cutting nippers) - ISO5746 (pliers).

**CUTTING EDGES WITH INDUCTION HARDENING**

for maximum efficiency in cutting the piano wire.

USAG PLIERS

OTHER PRODUCTS ON THE MARKET

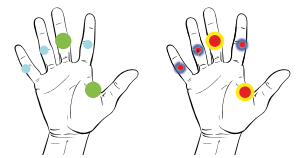

- EFFORT

+ EFFORT

Minimum effort resulting from the studies on muscle strain made by the prestigious US Ergonomics Institute.

PAGE 58



YouTube

**FULCRUM CLOSER TO THE CUTTING EDGES**

to reduce effort during cutting operations.

**ERGONOMIC BIMATERIAL GRIP**

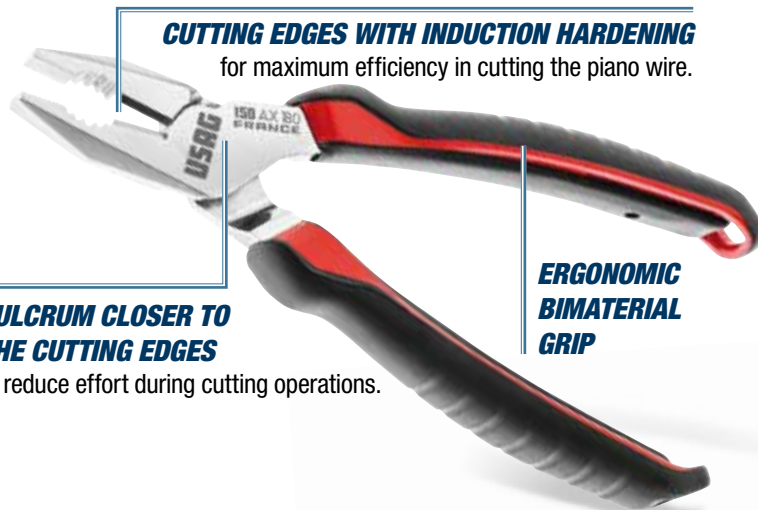

## 443 N Fast oil-filter wrench

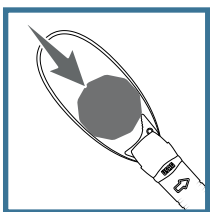

**AUTOMATIC BELT CLAMPING**

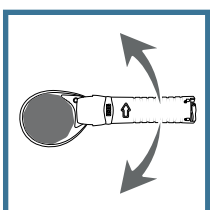

**RATCHET EFFECT**

Quick and easy to use even in narrow spaces.



66÷105 mm

**LEVER TO INCREASE CLAMPING POWER**

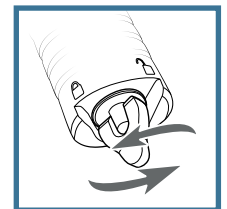

YouTube

PAGE 153

# RACING 519

## 519 RACING ROLLER CABINET

YOUR PREMIUM AND PROFESSIONAL WORKSHOP.

PAGE  
**196**



**TWO WHEELS WITH BRAKE**

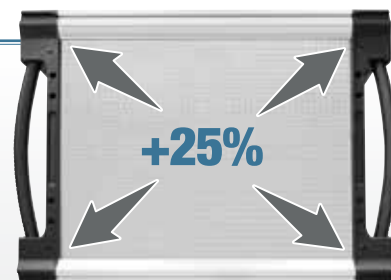

**A NEW WIDER WORKTOP WITH DOUBLE HANDLE**



### DOUBLE LAYER

Above: 2 mm aluminium plate.  
Below: 15 mm wooden piece.



 YouTube



**RUBBER BUMPERS ON STRUCTURE AND DRAWERS**



**NEW ALUMINIUM ERGONOMIC HANDLES WITH SELECTIVE OPENING**



**SLIDES WITH SOFT CLOSE SYSTEM**

# START516

## 516 START ROLLER CABINET MORE RESISTANT AND RELIABLE.

PAGE  
**189**

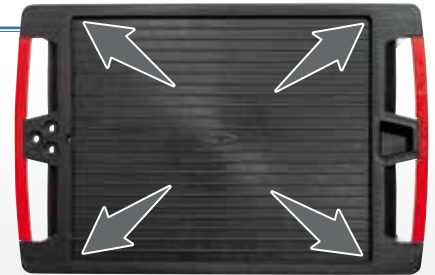

**NEW WORKTOP 460 X 560 mm  
WITH 15 mm SIDES**



YouTube



**STABLE AND CAPACIOUS:  
515 mm TOTAL DEPTH**



**HIGH RESISTANCE 35 MM SLIDES  
WITH A LOAD CAPACITY UP TO 40 KG**



**NEW DRAWER HANDLES IN HIGH  
RESISTANT ABS  
WITH SELECTIVE OPENING**

## COMBINATION WRENCH 285 X

### PERFECT ON NEW HEXAGON AND EFFECTIVE ON DAMAGED BOLT

**INCLINED OPEN END**  
angled at 15° as regards to wrench axis.



YouTube

**DOUBLE T SECTION**  
Excellent resistance to flexion.

**SPECIAL RING SHAPE**  
Ideal for operations on nuts difficult to reach.

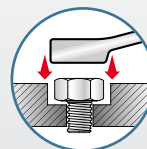

PAGE  
**120**

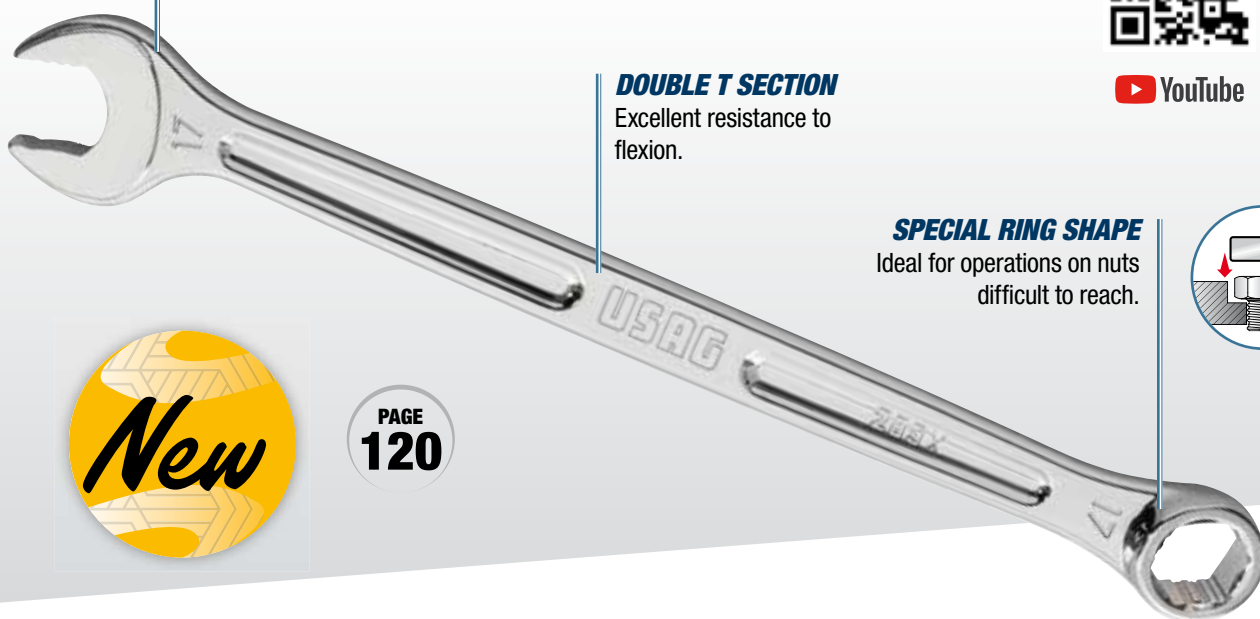

#### SPECIAL PROFILES

The internal profile of open/box end is designed to works on new hexagons and even on very damaged hexagons.



**+30% LONGER THAN A STANDARD COMBINATION WRENCH 285**  
It allows to apply a torque of 30% higher than the standard key.



# CLICK TORQUE BAR 811 LB

## PERFECT MATCH OF ACCURACY AND RESISTANCE



**QUICK CONNECTION**  
9x12 or 14x18 for accessories  
and ratchet heads

**New**

PAGE  
**266**

**CLICK TORQUE SYSTEM**  
with compression spring.

**READING SCALE**  
engraved on the wrench body.

**VERNIER**  
in steel.

**STEEL  
ADJUSTMENT RING**  
with automatic return.

**BIMATERIAL HANDLE**  
with no-slip grip.



YouTube

**ACCURACY**

**± 2%**

Accuracy tested in our factory.

**RESISTANT**

**50.000 clicks**

Resistance test of mechanism.

As per ISO 6789 Standard, USAG 811 LB click bars are tested one by one in production, before being packaged. These bars can keep an accuracy between  $\pm 2\%$  and  $\pm 4\%$ , even after 5.000 tightenings.

## POWER ASSIST SCREWDRIVER 324 XP

### SPEED OF THE BATTERY, ACCURACY OF YOUR HAND.



YouTube



**MAGNETIC BIT HOLDER**  
with quick release chuck.



**HANDLE**  
ergonomic in oil and chemicals resistant rubber.

**IEC 60529**



**LIGHT**  
with 5 frontal LED with automatic switch-off at 10 seconds.



**AUTOMATIC LOCKING SYSTEM**  
of the chuck to apply the torque by hand.

CE  
**EN 60529**

#### TECHNICAL CHARACTERISTICS

Vibrations (mm/s <sup>2</sup> )	1,4
Sound power dB(A)	54
Dimensions (mm)	170x39
Weight (gr)	245



**LITHIUM**  
3.6V - 2.0 Ah lithium battery.

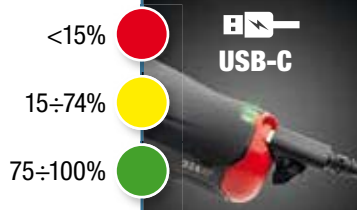

**RECHARGEABLE**  
LED indicator of the battery charge status. Complete recharge in 70 minutes. (IN: 5V 3A).

PAGE  
**138**

## POWER ASSIST SCREWDRIVER

**300**  
Giri/min



**ITS SPEED**  
Works with 300 rpm speed coming from the electric engine.

**YOUR ACCURACY**  
Close the tightening with the accuracy of a standard screwdriver.





# PLIER WRENCH 174 CX

## PLIER AND WRENCH IN THE SAME TOOL.



**QUICK ADJUST CLOSING**  
without pushing the button.



**PARALLEL JAWS**  
Internal design that fits perfectly the hexagon.



**FLAT JAWS**

**MAX. CAPACITY**  
**58 mm**

**METRIC SCALE**

**20 POSITIONS RAIL**

PAGE  
**60**

**PVC COVERED HANDLES**

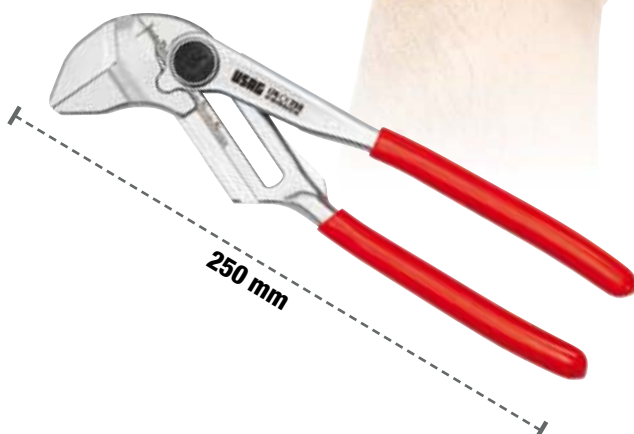

 YouTube

## RATCHET 237 D WITH SLIDING SQUARE DRIVE.

**60 THEET MECHANISM**  
with 6° working angle.

PAGE  
**85**

**CONICAL HANDLE**  
in anti-slip bimaterial.

**SLIDING SQUARE**

Pushing the square drive and turning the ratchet at 180°, you can inverse the working sense.

## KEY 280 TQ WITH BIT-HOLDER AND SOCKET SQUARE DRIVE.



PAGE  
**108**

**DOUBLE MAGNETIC  
BIT-HOLDER 1/4"**

1/4"



YouTube

1/4"

**1/4" SOCKETS  
SQUARE DRIVE**



YouTube



PAGE  
**273**



## ARTICULATED LED INSPECTION LAMP 889 IL

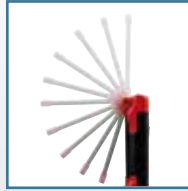

Jointed and 180° adjustable



Magnetic base and hook clamp

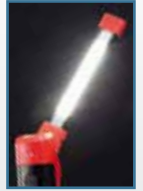

TRIPLE FUNCTION (head, front, torch)

**MAX 400 Lumen**



SMD LED



COB LED



Li-ion



PAGE  
**272**



YouTube

MOTION DETECTION SENSOR



## LED COMPACT SPOTLIGHT 889 GR



Just 91 mm length



Magnetic base adjustable up to 90°



Adjustable hook up to 360°



Fluorescent reflector

**MAX 500 Lumen**



SMD LED



IP54



Li-ion



YouTube

PAGE  
**274**



## LED INSPECTION LAMP 889 RL



DUAL USE: Lamp - Torch 2 brightness levels (120 and 420 lumen)



Adjustable hooks



4 LED battery indicator

**MAX 420 Lumen**



SMD LED



COB LED



Li-ion

# CATALOGUE

n.63/2023

## Caption

QR code

Picture

Item

ISO 7738

Description

Price

Number of pieces per box

Code

Size

**285**

**Combination wrenches**

- Chrome Vanadium steel
- Thin open end angled at 15°
- Ergonomic grip
- Bihexagonal head bent at 15°
- Ring head with hexagonal profile only for size 5,5 mm, bihex for rest of range

Ø mm	L mm	b mm	code	
5,5	115	3,8	U02850700	5
6	115	4,0	U02850701	5
7	122	4,1	U02850702	5
8	133	4,6	U02850703	5
9	138	4,6	U02850704	5
10	145	5,1	U02850705	5



News



Tools on hanging cards with barcode



Special items for automotive



Video on YouTube

By scanning the **QR code** placed near each product image, you will be directed to the web page of corresponding product. You will find detailed information in your language, videos, technical sheet etc.



## IMPORTANT

**USAG product codes have 9 digits: they begin with the letter “U” followed by 8 digits**

This Price List cancels and replaces all previous editions. Data and technical information mentioned above are valid at the time of printing. In order to improve some technical features, Stanley Black & Decker Italia S.r.l. reserves the right to introduce changes.

**Stanley Black & Decker Italia S.r.l.**

Via Volta, 3 - 21020 - Monvalle (VA) - Tel. +39 0332 790 111 - info.mv@usag.it - www.usag-tools.net



### 001 MV

#### Electronics and electrotechnics maintenance case (empty)

- Two removable panels equipped with tool storage pockets
- Lower compartment with mobile separators
- Document compartment
- Handle in ABS and double key lock
- Polypropilene shell with Aluminium frame
- Spare handle: code BV.51A05
- Kit with 2 spare locks: code BV.51A-04J2

LxPxH mm	kg	code	
490x395x200	5,3	U00010001	1

### 001 MF

#### Case with assortment 496 F2 for electronics (126 pcs.)

- See assortment at page 177



LxPxH mm	kg	code	
490x395x200	11,4	U00010101	1

### 001 MH 1000 V

#### Case with assortment 496 H2 for electrotechnics (85 pcs.)

- See assortment at page 177



LxPxH mm	kg	code	
490x395x200	14,4	U00010111	1



### 001 PV

#### Electronics and electrotechnics maintenance case (empty)

- Two panels for tool storage
- Lower compartment with mobile separators
- Document compartment
- Handle in ABS and double key lock
- Polypropilene shell with Aluminium frame
- Spare handle: code BV.51A05
- Kit with 2 spare locks: code BV.51A-04J2

LxPxH mm	kg	code	
490x395x200	6	U00010002	1

### 001 PF

#### Case with assortment 496 F2 for electronics (126 pcs.)

- See assortment at page 177



LxPxH mm	kg	code	
490x395x200	12,1	U00010102	1

### 001 PH 1000 V

#### Case with assortment 496 H2 for electrotechnics (85 pcs.)

- See assortment at page 177



LxPxH mm	kg	code	
490x395x200	15,1	U00010112	1



### 001 RV

#### Tool case in high thickness polypropilene (empty)

- Two inside removable panels with elastics to hold tools
- Lower compartment with mobile separators
- Double key lock
- Rubber coated ergonomic handle
- Three rear hinges and double metal shaft to hold the cover
- High thickness polypropilene shells assembled on Aluminium frame
- The structure provides resistance to corrosive media, to low and high temperatures and to shocks (even on the corners)

LxPxH mm	kg	code	
465x215x352	4,7	U00010004	1



### 1000 V

#### 001 RH14

#### Tool case with assortment for electrotechnics (14 pcs.)

pcs	description	item/size
1	Tool case in high thickness polypropilene (empty)	001 RV
1	Combination pliers - 1000 V	085 EX/180
4	Screwdrivers for slot-head screws - 1000 V / 0,5x3x75-0,8x4x100-1x5,5x125-1,2x6,5x150	091
2	Screwdrivers for PHILLIPS® screws - 1000 V / 1x100-2x125	091 PH
2	Screwdrivers for POZIDRIV® - SUPADRIV® screws - 1000 V / 1x100-2x125	091 PZ
1	Hacksaw with blade tensioner	201 S
1	Scissors for electricians, steel blades	207 C
1	Utility knife with snap-off blades	220 B1
1	Phase-testing screwdriver 110÷250V	321 F
1	Professional tape rules with shockproof covering	981 A/3

LxPxH mm	kg	code	
465x352x215	8	U00010114	1



### 001 TRV

#### Tool trolley in high thickness polypropilene (empty)

- Two inside removable panels with elastics to hold tools
- Lower compartment with mobile separators
- Double key lock
- Rubber coated ergonomic handle
- Three rear hinges and double metal shaft to hold the cover
- High thickness polypropilene shells assembled on Aluminium frame
- The structure provides resistance to corrosive media, to low and high temperatures and to shocks (even on the corners)
- Telescopic Aluminium handle
- Wheels with integrated roll bearings

LxPxH mm	kg	code	
465x255x352	6	U00010005	1



### 1000 V

#### 001 TRH14

#### Tool trolley with assortment for electrotechnics (14 pcs.)

pcs	description	item/size
1	Tool trolley in high thickness polypropilene (empty)	001 TRV
1	Combination pliers - 1000 V	085 EX/180
4	Screwdrivers for slot-head screws - 1000 V / 0,5x3x75-0,8x4x100-1x5,5x125-1,2x6,5x150	091
2	Screwdrivers for PHILLIPS® screws - 1000 V / 1x100-2x125	091 PH
2	Screwdrivers for POZIDRIV® - SUPADRIV® screws - 1000 V / 1x100-2x125	091 PZ
1	Hacksaw with blade tensioner	201 S
1	Scissors for electricians, steel blades	207 C
1	Utility knife with snap-off blades	220 B1
1	Phase-testing screwdriver 110÷250V	321 F
1	Professional tape rules with shockproof covering	981 A/3

LxPxH mm	kg	code	
465x352x255	9	U00010115	1

### 001 TRL

#### Spare lock

- For tool cases 001 RV and 001 TRV



code	
U00010004Q	1

### 001 TRW

#### Spare wheels

- For tool case 001 TRV



code	
U00010005Q	1



1/4

1/2



**002 JMA**

**Case with assortment for maintenance (181 pcs.)**

- Case with Aluminium section shell and metal reinforcements
- Double metal closing hinge with lock (key included)
- Handle with plastic protection
- Three internal panels equipped with elastics to hold tools
- Blocking system of the folding panel
- Base with cut-out bi-colour foam
- Tool-outlines on the panels and in the foam, in addition to the markings of the size of wrenches and sockets, enable quick identification of the required or missing tools

**pcs description**

16	Hexagonal sockets 1/2" 10-11-12-13-14-15-16-17-18-19-21-22-24-27-30-32 mm
13	Hexagonal sockets 1/4" 4-4,5-5-5,5-6-7-8-9-10-11-12-13-14 mm
2	Extensions 1/2" 130-250 mm
2	Extensions 1/4" 55-100 mm
1	Reversible ratchet 1/2"
1	Reversible ratchet 1/4"
1	Spinner with handle 1/4"
1	Universal joint 1/2"
1	Universal joint 1/4"
1	bit-holder socket 1/4-1/4"
12	Combination wrenches 8-9-10-11-12-13-14-15-16-17-18-19 mm
1	Adjustable wrench 250 mm
6	Screwdrivers for slot-head screws 0,4x2,5x50-0,5x3,5x75-0,8x4x100-1x5,5x125-1,2x6,5x150-1,6x8x175
2	Screwdrivers for PHILLIPS® screws 1x75-2x125
2	Screwdrivers for POZIDRIV®-SUPADRIV® screws 1x75-2x125
9	Angled hexagon keys 1,5-2-2,5-3-4-5-6-8-10 mm
1	Combination pliers 180 mm
1	Adjustable pliers 250 mm
1	Half-round pliers 160 mm
1	Diagonal cutting nippers 160 mm
1	Phase-testing screwdriver
1	Scissors for electricians
1	Utility knife
1	Tape rule 3 m
1	Mini hacksaw frame
1	Hammer for mechanics 300 gr
9	bits for slot-head screws 3-4-4,5-5-5,5-6-6,5-7-8
8	Bits for PHILLIPS® screws PH 00-0-1(x2)-2(x2)-3-4
5	Bits for POZIDRIV®-SUPADRIV® screws PZ 1-2(x2)-3-4
10	Bits for hex socket screws 1,5-2-2,5-3-4-5-5,5-6-7-8 mm
10	Bits for hex socket screws 1/16-5/64-3/32-7/64-1/8-9/64-5/32-3/16-7/32-1/4
10	TORX® bits T8-T9-T10-T15-T20-T25-T27-T30-T40-T45
9	TORX® Tamper Resistant bits T8-T10-T15-T20-T25-T27-T30-T35-T45
4	Tri-Wing bits 1-2-3-4
5	Spanner bits 4-6-8-10-12
3	Torq bits 6-8-10
5	Square bits 0-1-2(x2)-3
5	Clutch bits 1/8-5/32-3/16-1/4-5/16
3	Bits XZN M5-M6-M8
6	Hexagonal bits for hex socket screws with hole 2-2,5-3-4-5-6
6	Hexagonal bits for hex socket screws with hole 5/64-3/32-7/64-1/8-9/64-5/32
2	Magnetic extensions 1/4"

LxPxH mm	kg	code	
460x385x158	11	U00020011	1



1/4

1/2



**002 JMP**

**Case with assortment for maintenance, inch sizes (174 pcs.)**

- Case with Aluminium section shell and metal reinforcements
- Double metal closing hinge with lock (key included)
- Handle with plastic protection
- Three internal panels equipped with elastics to hold tools
- Blocking system of the folding panel

**pcs description**

pcs	description	item/size
1	Half-round extra-long nose pliers with straight jaws	133 AX/160
1	Combination pliers	150 AX/180
1	Box-joint adjustable pliers	180 C/250
1	Heavy-duty diagonal cutting nippers	188 AX/160
1	Hacksaw with blade tensioner	201 S
1	Scissors for electricians, steel blades	207 C
1	Utility knife with snap-off blades	220 B1
8	Set of 8 long angled hexagon keys with spherical head, inch sizes	280 LTSP/S8
12	Combination wrenches, inch sizes / 1/4-5/16-3/8-7/16-1/2-9/16-5/8-11/16-3/4-13/16-7/8-15/16	285 P
1	Adjustable wrenches with quick adjustment	294 AD/250
6	Screwdrivers for slot-head screws /0,4x2,5x50-0,5x3x75-0,8x4x100-1x5,5x125-1,2x6,5x150-1,6x8x175	324
2	Screwdrivers for PHILLIPS® screws/ 1x75-2x125	324 PH
2	Screwdrivers for POZIDRIV®-SUPADRIV® screws/1x75-2x125	324 PZ
1	Hammers for mechanics	382/300
15	Assortment with bihexagonal sockets in ABS case, in inches (15 pcs.)	606 1/2 APOL
18	Assortment with hexagonal sockets in ABS case, in inches (18 pcs.)	606 1/4 APOL
100	Assortment of bits with special shapes - 1/4" (100 pcs.)	692 J100
1	Professional tape rules with shockproof covering	981 A/3

LxPxH mm	kg	code	
460x385x158	12	U00020004	1



**002 JMV**

**Tool case (empty)**

- Case with Aluminium section shell and metal reinforcements
- Double metal closing hinge with lock (key included)
- Handle with plastic protection
- Three internal panels equipped with elastics to hold tools
- Blocking system of the folding panel

LxPxH mm	kg	code	
460x385x158		U00020001Q	1



1/4

1/2



**002 JTMA**

**Tool trolley with assortment for maintenance (181 pcs.)**

- Case with Aluminium section shell and metal reinforcements
- Double metal closing hinge with lock (key included)
- Handle with plastic protection
- Telescopic transport handle
- Integrated wheels
- Three internal panels equipped with elastics to hold tools
- Blocking system of the folding panel
- Base with cut-out bi-colour foam
- Tool-outlines on the panels and in the foam, in addition to the markings of the size of wrenches and sockets, enable quick identification of the required or missing tools



**pcs description**

16	Hexagonal sockets 1/2" 10-11-12-13-14-15-16-17-18-19-21-22-24-27-30-32 mm
13	Hexagonal sockets 1/4" 4-4,5-5-5,5-6-7-8-9-10-11-12-13-14 mm
2	Extensions 1/2" 130-250 mm
2	Extensions 1/4" 55-100 mm
1	Reversible ratchet 1/2"
1	Reversible ratchet 1/4"
1	Spinner with handle 1/4"
1	Universal joint 1/2"
1	Universal joint 1/4"
1	bit-holder socket 1/4-1/4"
12	Combination wrenches 8-9-10-11-12-13-14-15-16-17-18-19 mm
1	Adjustable wrench 250 mm
6	Screwdrivers for slot-head screws 0,4x2,5x50-0,5x3,5x75-0,8x4x100-1x5,5x125-1,2x6,5x150-1,6x8x175
2	Screwdrivers for PHILLIPS® screws 1x75-2x125
2	Screwdrivers for POZIDRIV®-SUPADRIV® screws 1x75-2x125
9	Angled hexagon keys 1,5-2-2,5-3-4-5-6-8-10 mm
1	Combination pliers 180 mm
1	Adjustable pliers 250 mm
1	Half-round pliers 160 mm
1	Diagonal cutting nippers 160 mm
1	Phase-testing screwdriver
1	Scissors for electricians
1	Utility knife
1	Tape rule 3 m
1	Mini hacksaw frame
1	Hammer for mechanics 300 gr
9	Bits for slot-head screws 3-4-4,5-5-5,5-6-6,5-7-8
8	Bits for PHILLIPS® screws PH 00-0-1(x2)-2(x2)-3-4
5	Bits for POZIDRIV®-SUPADRIV® screws PZ 1-2(x2)-3-4
10	Bits for hex socket screws 1,5-2-2,5-3-4-5-5,5-6-7-8 mm
10	Bits for hex socket screws 1/16-5/64-3/32-7/64-1/8-9/64-5/32-3/16-7/32-1/4
10	TORX® bits T8-T9-T10-T15-T20-T25-T27-T30-T40-T45
9	TORX® Tamper Resistant bits T8-T10-T15-T20-T25-T27-T30-T35-T45
4	Tri-Wing bits 1-2-3-4
5	Spanner bits 4-6-8-10-12
3	Torq bits 6-8-10
5	Square bits 0-1-2(x2)-3
5	Clutch bits 1/8-5/32-3/16-1/4-5/16
3	Bits XZN M5-M6-M8
6	Hexagonal bits for hex socket screws with hole 2-2,5-3-4-5-6
6	Hexagonal bits for hex socket screws with hole 5/64-3/32-7/64-1/8-9/64-5/32
2	Magnetic extensions 1/4"

LxPxH mm	kg	code	
470x370x200	11	U00020015	1



## 1000 V 002 JTME

### Tool trolley with assortment for maintenance (181 pcs.)

- Case with Aluminium section shell and metal reinforcements
- Double metal closing hinge with lock (key included)
- Handle with plastic protection
- Telescopic transport handle
- Integrated wheels
- Three internal panels equipped with elastics to hold tools
- Blocking system of the folding panel
- Base with cut-out bi-colour foam
- Tool-outlines on the panels and in the foam, in addition to the markings of the size of wrenches and sockets, enable quick identification of the required or missing tools

pcs	description	item/size
16	Hexagonal sockets 1/2" 10-11-12-13-14-15-16-17-18-19-21-22-24-27-30-32 mm	
13	Hexagonal sockets 1/4" 4-4.5-5-5.5-6-7-8-9-10-11-12-13-14 mm	
2	Extensions 1/2" 130-250 mm	
2	Extensions 1/4" 55-100 mm	
1	Reversible ratchet 1/2"	
1	Reversible ratchet 1/4"	
1	Spinner with handle 1/4"	
1	Universal joint 1/2"	
1	Universal joint 1/4"	
1	Bit-holder socket 1/4-1/4"	
1	Flessometro 3 m	
1	Half-round extra-long nose pliers with straight jaws - 1000 V	081 EX/160
1	Combination pliers - 1000 V	085 EX/180
1	Diagonal cutting nippers - 1000 V	087 EX/160
6	Screwdrivers for slot-head screws - 1000 V /0,4x2,5x50-0,5x3x75-0,8x4x100-1x5,5x125-1,2x6,5x150-1,2x8x150	091
2	Screwdrivers for PHILLIPS® screws - 1000 V /1x100-2x125	091 PH
2	Screwdrivers for POZIDRIV® - SUPADRIV® screws - 1000 V/1x100-2x125	091 PZ
1	Box-joint adjustable pliers	180 C/250
1	Hacksaw with blade tensioner	201 S
1	Scissors for electricians, steel blades	207 C
1	Utility knife with snap-off blades	220 B1
9	Set of 9 long angled hexagon keys with spherical head/1,5-2-2,5-3-4-5-6-8-10	280 LTS/S9
12	Combination wrenches 8-9-10-11-12-13-14-15-16-17-18-19 mm	285 J
1	Adjustable wrenches with quick adjustment	294 AD/250
1	Phase-testing screwdriver 110÷250V	321 F
1	Hammers for mechanics	382/300
100	Assortment of bits with special shapes - 1/4" (100 pcs.)	692 J100

LxPxH mm	code	img
470x370x200	U00020016	1



## 002 JTMV

### Tool trolley (empty)

- Case with Aluminium section shell and metal reinforcements
- Double metal closing hinge with lock (key included)
- Handle with plastic protection
- Telescopic transport handle
- Integrated wheels
- Three internal panels equipped with elastics to hold tools
- Blocking system of the folding panel

LxPxH mm	code	img
470x370x200	U00020003Q	1



## 1000 V

### 002 ME 20

### Electrotechnics maintenance case (20 pcs.)

- Case with Aluminum section shell and metal reinforcements
- Double metal closure with lock (key included)
- Handle with plastic protection
- Three internal tool panels with elastics to hold tools
- Locking system of the folding panel

pcs	description	item/size
1	Half-round extra-long nose pliers with straight jaws - 1000 V	081 EX/160
1	Combination pliers - 1000 V	085 EX/180
1	Diagonal cutting nippers - 1000 V	087 EX/160
6	Screwdrivers for slot-head screws - 1000 V /0,4x2,5x50-0,5x3x75-0,8x4x100-1x5,5x125-1,2x6,5x150-1,2x8x150	091
2	Screwdrivers for PHILLIPS® screws - 1000 V /1x100-2x125	091 PH
2	Screwdrivers for POZIDRIV® - SUPADRIV® screws - 1000 V/1x100-2x125	091 PZ
1	Lay-on slip-joint adjustable pliers	178 N/250
1	Hacksaw with blade tensioner	201 S
1	Scissors for electricians, steel blades	207 C
1	Utility knife with snap-off blades	220 B1
1	Phase-testing screwdriver 110÷250V	321 F
1	Hammers for mechanics	382/300
1	Professional tape rules with shockproof covering	981 A/3

LxPxH mm	kg	code	img
460x385x158	6	U00020002	1



## 1000 V

### 002 TME 20

### Electrotechnics maintenance case (20 pcs.)

- Case with Aluminum section shell and metal reinforcements
- Double metal closure with lock (key included)
- Handle with plastic protection
- Three internal tool panels with elastics to hold tools
- Locking system of the folding panel

pcs	description	item/size
1	Half-round extra-long nose pliers with straight jaws - 1000 V	081 EX/160
1	Combination pliers - 1000 V	085 EX/180
1	Diagonal cutting nippers - 1000 V	087 EX/160
6	Screwdrivers for slot-head screws - 1000 V /0,4x2,5x50-0,5x3x75-0,8x4x100-1x5,5x125-1,2x6,5x150-1,2x8x150	091
2	Screwdrivers for PHILLIPS® screws - 1000 V/1x100-2x125	091 PH
2	Screwdrivers for POZIDRIV® - SUPADRIV® screws - 1000 V/1x100-2x125	091 PZ
1	Lay-on slip-joint adjustable pliers	178 N/250
1	Hacksaw with blade tensioner	201 S
1	Scissors for electricians, steel blades	207 C
1	Utility knife with snap-off blades	220 B1
1	Phase-testing screwdriver 110÷250V	321 F
1	Hammers for mechanics	382/300
1	Professional tape rules with shockproof covering	981 A/3

LxPxH mm	code	img
470x370x200	U00020006	1



## 007/1V

### Professional tool bag - (empty)

- Model in high strength fabric
- Rigid waterproof bottom
- Inside space for tools
- Aluminium handle with covered handgrip
- 2 front pockets for small objects, 1 side pocket with Velcro closure, 1 side open pocket for quick access to contents, 4 rear pockets protected by the soft top
- 2 internal hooks for tape rule and 6 elastics to hold tools
- 1 pocket with 4 elastics to hold tools and 11 elastics for screwdrivers
- Soft top cover with Velcro
- Maximum load: 11 kg
- Capacity: 34 L

LxPxH mm	kg	code	img
420x240x340	2.5	U00070001	1



### 007 V

#### Professional tool bag - (empty)

- Model in high strength fabric
- Rigid waterproof bottom
- Toolholder compartments and front pocket for a saw
- Aluminium handle with covered handgrip
- Transport shoulder strap
- Soft top cover with Velcro
- Maximum load: 15 kg
- Capacity: 47 L

LxPxH mm	kg	code	
490x220x350	4	U00070002	1



### 007 TXV

#### Trolley tool bag (empty)

- Model in high strength fabric
- Telescopic Aluminium handle
- 6 external pockets and 1 front pocket for a saw
- Toolholder compartments
- Aluminium handle with covered handgrip
- Soft top cover with Velcro
- Maximum load: 18 kg
- Capacity: 33 L

LxPxH mm	kg	code	
550x360x440	5,4	U00070065	1



### 007 FBV

#### Folding tool bag (empty)

- High strength fabric
- 8 pockets for tools
- Elastic straps to hold a hammer
- Two handles for good grip
- Rear belt to fix the bag to a trolley (not included)
- Optional shoulder belt: code U00070001Q
- Maximum load: 10 kg
- Capacity: 3 L



LxPxH mm	gr	code	
360x70x290	900	U00070041	1



### 007 FBI

#### Folding tool bag with assortment for MAINTENANCE (20 pcs.)

pcs	description	item/size
1	Folding tool bag (empty)	007 FBV
1	Combination pliers	150 CX/180
1	Box-joint adjustable pliers	180 C/250
1	Hacksaw	201
1	Scissors for electricians, stainless steel blades	207 D
9	Set of 9 long angled hexagon keys with spherical head/1,5-2-2,5-3-4-5-6-8-10	280 LTS/S9
1	Adjustable wrenches with quick adjustment	294 AD/200
3	Screwdrivers for slot-head screws/0,8x4x100-1x5,5x100-0,6x3,5x75	322
2	Screwdrivers for PHILLIPS® screws/1x100-2x125	322 PH
1	Hammers for mechanics	382/300

LxPxH mm	gr	code	
360x70x290	3	U00070056	1



NEW

### 007 FLV

#### Tool bag (empty)

- Model in high strength Fabric
- Frontal pocket with zipper closure
- Back pocket with velcro closure
- Rigid reinforced bottom
- Internal toolholder compartments
- Handles with PVC cover
- Maximum load: 9 kg
- Capacity: 8 L

LxPxH mm	gr	code	
310x140x220	600	U00070007	1



### 007 FTSV

#### Folding tool bag (empty)

- High strength fabric
- 8 pockets for tools
- Central internal tool panel with elastics on both sides
- Elastic straps to hold a hammer
- Handle with rubber coating
- Rear belt to fix the bag to a trolley
- Possibility to add a shoulder belt (not included)
- Optional shoulder belt: code U00070001Q
- Maximum load: 18 kg
- Capacity: 3 L



LxPxH mm	gr	code	
340x90x235	900	U00070060	1



### 007 A

#### Professional tool bag with assortment (32 pcs.)

pcs	description	item/size
1	Professional tool bag - (empty)	007 V
1	Combination pliers	150 AX/180
1	Lay-on slip-joint adjustable pliers	178 N/250
1	Diagonal cutting nippers	185 AX/160
1	Hacksaw	200
1	Multi-purpose scissors	211 A
1	Utility knife with snap-off blades	220 B1
8	Set of 8 double ended open jaw wrenches /6x7-8x9-10x11-12x13-14x15-16x17-18x19-20x22	252 N/SR8
9	Set of 9 angled hexagon keys / 1,5-2-2,5-3-4-5-6-8-10	280 N/S9
4	Screwdrivers for slot-head screws/0,5x3x75-0,8x4x100-1x5,5x125-1,2x6,5x150	324
2	Screwdrivers for PHILLIPS® screws / 1x75-2x100	324 PH
1	Hammers for mechanics	382/500
1	Pen-type LED torch in Aluminium - 110 Lumen	889 TS
1	Professional tape rules with shockproof covering	981 A/5

LxPxH mm	kg	code	
490x220x350	8	U00070010	1

Would you like to customize the bags with your company logo?



Send your request to: [prodotti.speciali@mygts.net](mailto:prodotti.speciali@mygts.net)





NEW

### 007 MCV

#### Tool bag (empty)

- Model in high strength Fabric
- Rigid waterproof bottom
- Internal toolholder compartments
- 3 front pockets with soft top protections
- 3 back pockets
- Handles with PVC cover
- Transport shoulder strap
- Maximum load: 10 kg
- Capacity: 15 L

LxPxH mm	kg	code	img
360x190x290	1	U00070008	1



### 007 MV

#### Tool-holding pouch (empty)

- High strength fabric
- Velcro belt fixing
- Four stretch pockets for tools
- Hook for tape
- Maximum load: 5 kg



LxH mm	gr	code	img
155x270	247	U00070035	1



### 1000 V

#### 007 ME

#### Tool-holding pouch with assortment for electricians (4 pcs.)

pcs	description	item/size
1	Tool-holding pouch (empty)	007 MV
2	Screwdrivers for slot-head screws - 1000 V / 0,5x3x75-0,8x4x100	091
1	Screwdrivers for PHILLIPS® screws - 1000 V/1x100	091 PH
1	Scissors for electricians, steel blades	207 C

LxH mm	kg	code	img
155x270	565	U00070036	1



### 007 MI

#### Tool-holding pouch with assortment for maintenance (5 pcs.)

pcs	description	item/size
1	Tool-holding pouch (empty)	007 MV
1	Multifunction combination pliers	155 AX/180
1	Scissors for electricians, steel blades	207 C
1	Screwdrivers for slot-head screws	324/0,8x4x100
2	Screwdrivers for PHILLIPS® screws/ 1x75-2x100	324 PH

LxH mm	gr	code	img
155x270	900	U00070037	1



### 007 MLV

#### Tool-holding pouch with belt (empty)

- High strength fabric
- Six stretch pockets for tools
- Hook for tape
- Adjustable belt from 80 to 120 cm
- Maximum load: 8 kg



LxH mm	gr	code	img
250x280	345	U00070030	1



### 1000 V

#### 007 MLE

#### Tool-holding pouch with assortment for electricians (7 pcs.)

pcs	description	item/size
1	Tool-holding pouch with belt (empty)	007 MLV
2	Screwdrivers for slot-head screws - 1000 V / 0,5x3x75-0,8x4x100	091
1	Screwdrivers for PHILLIPS® screws - 1000 V/1x100	091 PH
1	Scissors for electricians, steel blades	207 C
1	Utility knife with snap-off blades	220 B1
1	Phase-testing screwdriver 110÷250V	321 F
1	Professional tape rules with shockproof covering	981 A/3

LxH mm	kg	code	img
250x280	1	U00070038	1



### 007 MLI

#### Tool-holding pouch with assortment for maintenance (9 pcs.)

pcs	description	item/size
1	Tool-holding pouch with belt (empty)	007 MLV
1	Multifunction combination pliers	155 AX/180
1	Lay-on slip-joint adjustable pliers	178 N/250
1	Scissors for electricians, steel blades	207 C
1	Adjustable wrenches with quick adjustment	294 AD/200
2	Screwdrivers for slot-head screws/ 0,8x4x100-1x5,5x125	324
2	Screwdrivers for PHILLIPS® screws/ 1x75-2x100	324 PH
1	Professional tape rules with shockproof covering	981 A/3

LxH mm	kg	code	img
250x280	1,8	U00070039	1



### 007 ORV

#### Organizer - (empty)

- High strength fabric
- Nine tool-holding spaces
- Can be hung on the wall
- Can be stored inside backpack 007SV
- Maximum loading capacity: 4 kg
- Maximum load: 4 kg



LxPxH mm	gr	code	img
200x160x260	800	U00070031	1



### 007 PCV

#### Laptop bag (empty)

- High strength fabric
- Three inside pockets
- Removable strap for easy carrying
- Two handles for better grip
- Back strap to fix it to a trolley
- Possibility to store a Laptop (340x240 mm)
- Maximum loading capacity: 5 kg
- Maximum load: 5 kg
- Capacity: 7 L

LxPxH mm	gr	code	img
400x60x290	800	U00070032	1



### 007 PLV

#### Bag for plumbers (empty)

- High strength fabric
- Rigid riveted bottom for higher resistance
- Inside pocket for documents
- Can hold a 1.1/2" pipe wrench
- Outside hook for tape rule
- Removable shoulder strap for extra comfort during transport
- Two top handles for better grip
- Closure with Velcro and quick release snap buckles
- Maximum load: 25 kg
- Capacity: 9 L

LxPxH mm	kg	code	
450x180x170	1,7	U00070034	1



### 007 PMV

#### Bag for plumbers with PVC covering (empty)

- Waterproof semi-rigid structure with PVC coating
- Rigid riveted bottom for higher resistance
- Inside document holder
- Can hold a 2" pipe wrench
- Inside hook for tape rule
- Removable shoulder strap for extra comfort during transport
- Two inside handles
- Closure with quick release snap buckles
- Maximum load: 15 Kg
- Capacity: 12 L

LxPxH mm	kg	code	
540x155x210	1,5	U00070045	1



### 007 RV

#### Bag for laptop and tools (empty)

- High strength fabric
- Rigid reinforced bottom
- The front opening allows quick access to content
- Padded compartment for notebook and documents (inside dimensions: 340x240 mm)
- 14 pockets, 2 tool straps and 1 hook for tape rule
- Removable shoulder strap for extra comfort during transport
- Closure with quick release snap buckles
- Maximum load: 15 kg
- Capacity: 8 L

LxPxH mm	kg	code	
460x160x350	1,8	U00070033	1



### 007 TR

#### Spare shoulder strap

- For tool bags 007/1V, 007 V, 007 PCV, 007 PLV, 007 RV, 007 FBV, 007 FTSV

code	
U00070001Q	1



### 007 SBV

#### Compact tool pouch (empty)

- High strength fabric
- Main compartment with zip closure
- Back pocket with zip closure
- Maximum load: 5 kg
- Capacity: 1 L



LxPxH mm	gr	code	
260x50x110	60	U00070040	1



### 007 SB 150 CX

#### Compact tool pouch with screwdrivers and combination pliers (14 pcs.)

pcs	description	item/size
1	Compact tool pouch (empty)	007 SBV
1	Combination pliers	150 CX/180
9	Set of 9 long angled hexagon keys with spherical head/1,5-2-2,5-3-4-5-6-8-10	280 LTS/S9
2	Screwdrivers for slot-head screws/0,5x3x75-0,8x4x100	322
2	Screwdrivers for PHILLIPS® screws / 1x100-2x125	322 PH

LxPxH mm	kg	code	
260x50x110	1	U00070052	1



### 007 SB 178 NC

#### Compact tool pouch with screwdrivers, angled hex keys, adjustable pliers and scissors (13 pcs.)

pcs	description	item/size
1	Compact tool pouch (empty)	007 SBV
1	Lay-on slip-joint adjustable pliers	178 N/250
1	Scissors for electricians, steel blades	207 C
9	Set of 9 angled hexagon keys / 1,5-2-2,5-3-4-5-6-8-10	280 N/S9
1	Screwdrivers for slot-head screws	322/0,8x4x100
1	Screwdrivers for PHILLIPS® screws	322 PH/1x100

LxPxH mm	kg	code	
260x50x110	1,1	U00070053	1



### 007 SB 294 AC

#### Compact tool pouch with adjustable wrench and ratchet wrenches (4 pcs.)

pcs	description	item/size
1	Compact tool pouch (empty)	007 SBV
3	Reversible ratchet combination wrenches with locking ring/8-10-13	285 KA
1	Short adjustable wrench	294 AC

LxPxH mm	gr	code	
260x50x110	625	U00070054	1



### 007 SV

#### Professional backpack (empty)

- High strength fabric
- Adjustable chest strap
- Padded waist straps to distribute the weight evenly
- Rigid waterproof bottom
- Inside tool-holding space
- Side and front pockets
- Inside document holder
- Padded compartment for notebook and documents (inside dimensions: 340x240 mm)
- Maximum load: 12 kg
- Capacity: 30 L





## 007 TV

### Professional tool trolley (empty)

- Cabin size dimensions
- High strength fabric
- Inside toolholding spaces
- Front document pocket
- Side pockets with straps for long objects
- Telescopic Aluminium handle
- Wheels integrated into the structure
- Back shoulder straps
- Padded compartment for notebook and documents (inside dimensions: 340x240 mm)
- Maximum load: 14 kg
- Capacity: 30 L



LxPxH mm	kg	code	
350x200x500	3,5	U00070006	1



## 008 V

### Large roller case (empty)

- Panels with elastic straps for tool storage
- Double document compartment
- Lower compartment with three boxes for small objects
- Double lock with TSA homologation
- Telescopic handle and large wheels with ball bearings
- Polypropilene shell with Aluminium frame
- Maximum loading capacity 30 kg
- Inside volume: 63 dm<sup>3</sup> about
- Side handles kit (2 pieces): code BV.61SE2
- Spare telescopic handle: code BV.61TC1
- Spare wheels kit (2 pieces): code BV.61-01
- Spare lock: code 1004729-96

LxPxH mm	kg	code	
515x425x350	8,5	U00080001	1

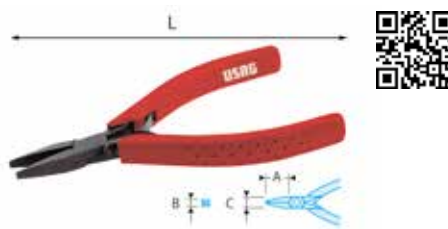

### 015/1 ISO 9655 ASME B107.500

#### Flat short nose pliers with straight jaws

- Smooth jaws
- Leaf interchangeable springs
- Ergonomic ABS grip, resistant to oil and solvents

axbxc mm	L mm	g	code	
20x1x9	120	55	U00150001	1

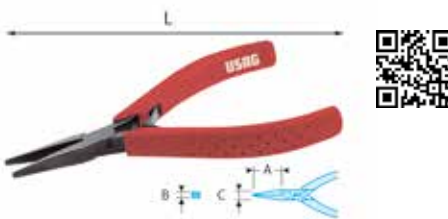

### 015/2 ISO 9655 ASME B107.500

#### Flat short nose pliers with straight tapered jaws

- Smooth tapered and rounded jaws
- Leaf interchangeable springs
- Ergonomic ABS grip, resistant to oil and solvents

axbxc mm	L mm	g	code	
21x1x9	125	60	U00150002	1

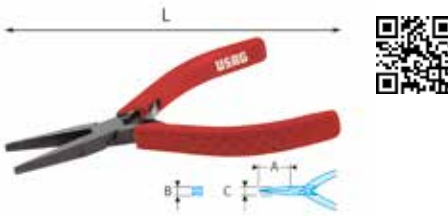

### 015/3 ISO 9655 ASME B107.500

#### Flat long nose pliers with straight jaws

- Smooth jaws
- Leaf interchangeable springs
- Ergonomic ABS grip, resistant to oil and solvents

axbxc mm	L mm	g	code	
33x1x11	130	75	U00150003	1

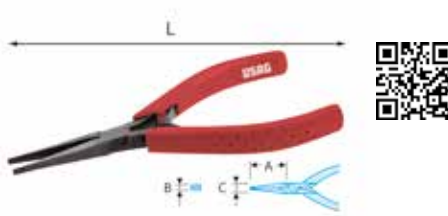

### 015/4 ISO 9655 ASME B107.500

#### Flat long nose pliers with straight tapered jaws

- Smooth tapered jaws
- Leaf interchangeable springs
- Ergonomic ABS grip, resistant to oil and solvents
- For high precision

axbxc mm	L mm	g	code	
35x1x9	135	80	U00150004	1

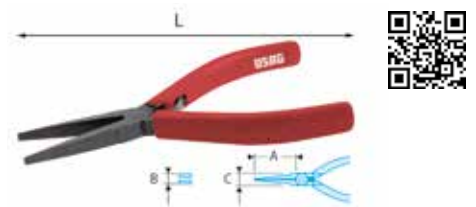

### 015/5 ISO 9655 ASME B107.500

#### Flat extra-long nose pliers with straight jaws

- Smooth jaws
- Leaf interchangeable springs
- Ergonomic ABS grip, resistant to oil and solvents

axbxc mm	L mm	g	code	
48x1x14	160	80	U00150005	1



### 016/1 ISO 9655 ASME B107.500

#### Round short nose pliers with straight jaws

- Smooth jaws
- Leaf interchangeable springs
- Ergonomic ABS grip, resistant to oil and solvents

axbxc mm	L mm	g	code	
22x2x11	120	55	U00160001	1



### 017/1 ISO 9655 ASME B107.500

#### Half-round short nose pliers with straight jaws

- Smooth jaws
- Leaf interchangeable springs
- Ergonomic ABS grip, resistant to oil and solvents

axbxc mm	L mm	g	code	
26x1,5x9	120	55	U00170001	1



### 017/2 ISO 9655 ASME B107.500

#### Half-round short nose pliers with jaws at 60°

- Smooth jaws
- Leaf interchangeable springs
- Ergonomic ABS grip, resistant to oil and solvents

axbxc mm	L mm	g	code	
25x1,4x11	125	70	U00170002	1

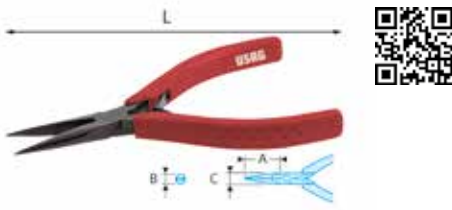

**017/3** ISO 9655 ASME B107.500

**Half-round long nose pliers with straight jaws**

- Smooth jaws
- Leaf interchangeable springs
- Ergonomic ABS grip, resistant to oil and solvents

axbxc mm	L mm	g gr	code
33x0,5x11	130	70	U00170003

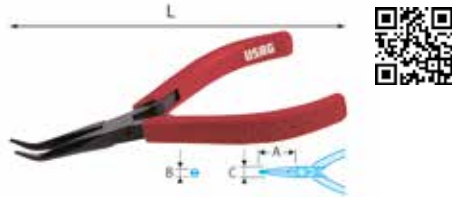

**017/4** ISO 9655 ASME B107.500

**Half-round long tapering nose pliers with jaws at 45°**

- Smooth jaws
- Leaf interchangeable springs
- Ergonomic ABS grip, resistant to oil and solvents
- For high precision

axbxc mm	L mm	g gr	code
35x1,6x9	135	75	U00170004



**017/5** ISO 9655 ASME B107.500

**Half-round long nose pliers with tapered straight jaws**

- Smooth jaws
- Leaf interchangeable springs
- Ergonomic ABS grip, resistant to oil and solvents
- For high precision

axbxc mm	L mm	g gr	code
35x1,6x9	140	65	U00170005



**017/6** ISO 9655 ASME B107.500

**Half-round extra-long nose pliers with jaws at 40°**

- Smooth jaws
- Leaf interchangeable springs
- Ergonomic ABS grip, resistant to oil and solvents

axbxc mm	L mm	g gr	code
45x1,6x14	155	75	U00170006

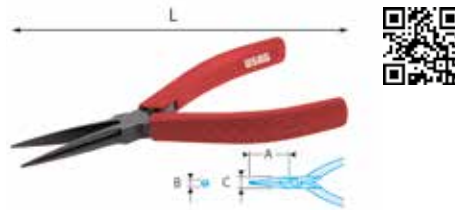

**017/7** ISO 9655 ASME B107.500

**Half round extra-long pliers with straight jaws**

- Smooth jaws
- Leaf interchangeable springs
- Ergonomic ABS grip, resistant to oil and solvents

axbxc mm	L mm	g gr	code
35x1,6x9	140	65	U00170007



**020/1** ISO 9654 ASME B107.500

**Thin nose cutting nippers with semi-flush cutting edge**

- Pointed jaws
- Leaf interchangeable springs
- Ergonomic ABS grip, resistant to oil and solvents
- Model particularly suitable for working on printed circuit boards

characteristics	size
CuNi capacity (mm)	Ø 0,1-0,8
Fe 30 HRc capacity (mm)	Ø 0,4

axbxc mm	L mm	g gr	code
10,5x10,5x9,5	110	60	U00200001



**020/2** ISO 9654 ASME B107.500

**Standard nose cutting nippers with semi-flush cutting edge**

- Small rounded jaws for narrow spaces
- Leaf interchangeable springs
- Ergonomic ABS grip, resistant to oil and solvents
- Wire retain system

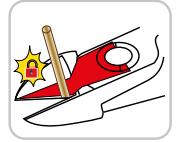

characteristics	size
CuNi capacity (mm)	Ø 0,1-0,9
Fe 30 HRc capacity (mm)	Ø 0,5

axb mm	L mm	g gr	code
10,5x10,5	110	60	U00200002

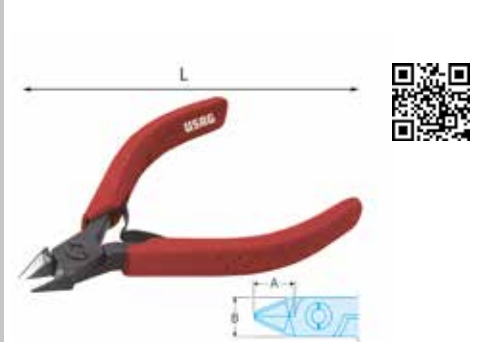

**020/3** ISO 9654 ASME B107.500

**Standard nose cutting nippers with semi-flush cutting edge**

- Small rounded jaws for narrow spaces
- Leaf interchangeable springs
- Ergonomic ABS grip, resistant to oil and solvents

characteristics	size
CuNi capacity (mm)	Ø 0,1-0,9
Fe 30 HRc capacity (mm)	Ø 0,5

axb mm	L mm	g gr	code
10,6x10,5	110	60	U00200003

**GUIDE TO CHOICE**

NOSE	SYMBOL	FEATURES
FLAT		<ul style="list-style-type: none"> <li>• Wide nose for larger gripping surface</li> <li>• Ideal for handle and place electronic components (eg resistors, capacitors)</li> <li>• Suitable also for car repair (mechanical or electrical), micromechanics and model-making</li> </ul>
HALF-ROUND		<ul style="list-style-type: none"> <li>• Tapered nose for precise grip</li> <li>• Ideal for handle and place electronic component feet and small items during welding or assembly</li> <li>• Suitable also for car repair (mechanical or electrical), micromechanics and model-making</li> </ul>
ROUND		<ul style="list-style-type: none"> <li>• Pointed and thin nose for precision works or for use in places difficult to reach</li> <li>• Ideal for shaping the copper wire or to use in conjunction with flat-nose pliers during welding operations or assembly</li> </ul>



**020/4**  **ISO 9654 ASME B107.500**

**High capacity cutting nippers with semi-flush cutting edge**

- Leaf interchangeable springs
- Ergonomic ABS grip, resistant to oil and solvents
- For major efforts and repetitive works

characteristics	size
CuNi capacity (mm)	Ø 0,3-1,6
Fe 30 HRc capacity (mm)	Ø 0,7

axb mm	L mm	gr	code	
16x16	125	95	U00200004	1



**021/1**  **ISO 9654 ASME B107.500**

**Ultra compact cutting nippers with semi-flush cutting edge**

- Rounded jaws
- Leaf interchangeable springs
- Ergonomic ABS grip, resistant to oil and solvents
- Model suitable for miniaturized electronic components

characteristics	size
CuNi capacity (mm)	Ø 0,1-1

axb mm	L mm	gr	code	
9x8,5	110	60	U00210001	1



**021/2**  **ISO 9654 ASME B107.500**

**Compact cutting nippers with semi-flush cutting edge**

- Rounded jaws
- Leaf interchangeable springs
- Ergonomic ABS grip, resistant to oil and solvents
- High cutting performance and easy handling with the new ogival thinned shape
- Wire retain system

characteristics	size
CuNi capacity (mm)	Ø 0,1-1
Fe 30 HRc capacity (mm)	Ø 0,6

axb mm	L mm	gr	code	
9,5x10,5	110	60	U00210002	1



**021/3**  **ISO 9654 ASME B107.500**

**Grooved nose cutting nippers with semi-flush cutting edge**

- Rounded jaws
- Leaf interchangeable springs
- Ergonomic ABS grip, resistant to oil and solvents
- High cutting performance and easy handling with the new ogival thinned shape

characteristics	size
CuNi capacity (mm)	Ø 0,1-1,3
Fe 30 HRc capacity (mm)	Ø 0,7

axb mm	L mm	gr	code	
9,5x10,5	110	60	U00210003	1



**021/4**  **ISO 9654 ASME B107.500**

**Long nose cutting nippers with semi-flush cutting edge**

- Rounded jaws
- Leaf interchangeable springs
- Ergonomic ABS grip, resistant to oil and solvents
- Allows greater accessibility: up to 1.5-2 mm more than a standard cutter

characteristics	size
CuNi capacity (mm)	Ø 0,1-1,3
Fe 30 HRc capacity (mm)	Ø 0,7

axb mm	L mm	gr	code	
13x10,5	110	60	U00210004	1



**021/5**  **ISO 9654 ASME B107.500**

**Heavy-duty cutting nippers with semi-flush cutting edge**

- Rounded jaws
- Leaf interchangeable springs
- Ergonomic ABS grip, resistant to oil and solvents
- Suitable for heavy efforts and repetitive work on a wide range of materials

characteristics	size
CuNi capacity (mm)	Ø 0,3-2
Fe 30 HRc capacity (mm)	Ø 0,9

axb mm	L mm	gr	code	
16x16	125	95	U00210005	1



**022/1**  **ISO 9654 ASME B107.500**

**Ultra compact cutting nippers with flush cutting edge**

- Rounded jaws
- Leaf interchangeable springs
- Ergonomic ABS grip, resistant to oil and solvents
- Ultra compact model for miniaturized electronic components

characteristics	size
CuNi capacity (mm)	Ø 0,2-1

axb mm	L mm	gr	code	
9x8,5	110	60	U00220001	1



**022/2**  **ISO 9654 ASME B107.500**

**Thin long nose cutting nippers with flush cutting edge**

- Grooved rounded jaws to cut behind the components and under obstacles (coils, resistors...)
- Leaf interchangeable springs
- Ergonomic ABS grip, resistant to oil and solvents
- Ultra compact model for miniaturized electronic components



characteristics	size
CuNi capacity (mm)	Ø 0,1-1,2

axbxc mm	L mm	gr	code	
13x10,5x5,5	110	60	U00220002	1

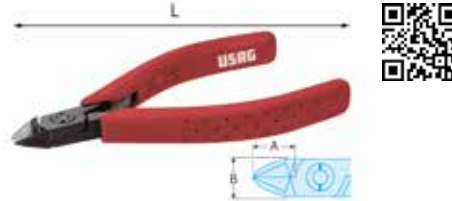

**022/3**  **ISO 9654 ASME B107.500**

**Compact cutting nippers with flush cutting edge**

- Rounded jaws
- Leaf interchangeable springs
- Ergonomic ABS grip, resistant to oil and solvents
- Ultra compact model for miniaturized electronic components
- High cutting performance and easy handling with the new ogival thinned shape

characteristics	size
CuNi capacity (mm)	Ø 0,1-1,3

axb mm	L mm	gr	code	
9,5x10,5	110	60	U00220003	1

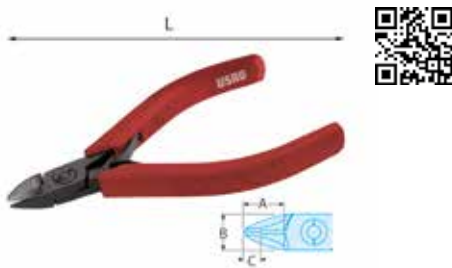

**022/4**  **ISO 9654 ASME B107.500**

**Long nose cutting nippers with flush cutting edge**

- Rounded jaws
- Leaf interchangeable springs
- Ergonomic ABS grip, resistant to oil and solvents
- Ultra compact model for miniaturized electronic components
- Allows greater accessibility: up to 1.5-2 mm more than a standard cutter

characteristics	size
CuNi capacity (mm)	Ø 0,1-1,3

axbxc mm	L mm	g gr	code	
13x10,5x5,5	110	60	U00220004	1

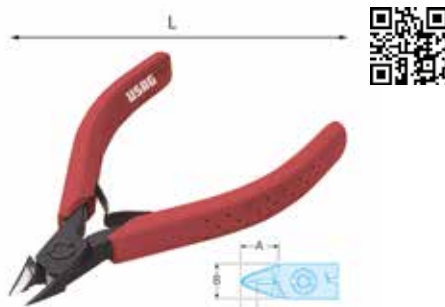

**024/1**  **ISO 9654 ASME B107.500**

**Thin nose cutting nippers with flush cutting edge**

- Pointed grooved jaws
- Leaf interchangeable springs
- Ergonomic ABS grip, resistant to oil and solvents
- Access between the tabs of the DIP components with a pitch of 0,65 mm
- Considering the extremely small thickness of the tips, this cutter can only be used for this function.



characteristics	size
CuNi capacity (mm)	Ø 0,1-0,6

axbxc mm	L mm	g gr	code	
10,5x10,5x6,5	110	60	U00240001	1



**024/2**  **ISO 9654 ASME B107.500**

**Thin nose cutting nippers with flush cutting edge**

- Pointed jaws
- Leaf interchangeable springs
- Ergonomic ABS grip, resistant to oil and solvents
- Model particularly suitable for working on printed circuit boards

characteristics	size
CuNi capacity (mm)	Ø 0,1-0,8
Fe 30 HRC capacity (mm)	Ø 0,4

axbxc mm	L mm	g gr	code	
10,5x10,5x9,5	110	60	U00240002	1



**030/1**  **ISO 9654 ASME B107.500**

**Ultra compact cutting nippers with axial cutting edge**

- Rounded jaws
- Leaf interchangeable springs
- Ergonomic ABS grip, resistant to oil and solvents
- Model suitable for miniaturized electronic components

characteristics	size
CuNi capacity (mm)	Ø 0,2-1
Fe 30 HRC capacity (mm)	Ø 0,5

axb mm	L mm	g gr	code	
9x8,5	110	60	U00300001	1



**030/2**  **ISO 9654 ASME B107.500**



**Compact cutting nippers with axial cutting edge**

- Rounded jaws
- Leaf interchangeable springs
- Ergonomic ABS grip, resistant to oil and solvents
- High cutting performance and great maneuverability with the new ogival thinned shape

characteristics	size
CuNi capacity (mm)	Ø 0,3-1,3
Fe 30 HRC capacity (mm)	Ø 0,7
Piano wire capacity (mm)	Ø 0,5

axb mm	L mm	g gr	code	
9,5x10,5	110	60	U00300002	1

**GUIDE TO CHOICE**

CUTTING EDGES	SYMBOL	FEATURES	WIRE TYPE	OPERATION	APPLICA-TION	
AXIAL CUT		Cutting edges are treated to achieve maximum strength and precision cutting of a wide range of materials, from piano wire to copper.	Cu	✓	- Production work	- Customer service (hi-fi)
			CuNi alloy CuNi	✓	- Day-to-day use	- Machine-tools
			Mild steel 30 HRC	✓	- Maintenance	- Automotive
			Hard steel 50 HRC Piano wire	✓	- Hard materials	- Domestic appliances
SEMI-FLUSH CUT		Micro-chamfered cutting edges ensure high cutting capacity with clean finish. Precision is maintained throughout a long service life even in intensive use. Suitable for semi-hard wire	Cu	✓	- Clean cut in intensive use	- Computers
			CuNi alloy	✓	- Wiring	- Telephone exchanges
			Mild steel 30 HRC	✓	- Batch electronics	- Video and laser
			Hard steel 50 HRC Piano wire	✗	- Semi-hard materials	- Micro-Tech (hi-fi, labs)
FLUSH CUT		This range is designed to give a through-cut without crushing the wire. Clean-cut ends allow reliable soldering, without damage to electronic components from arcing. Suitable for soft wire only	Cu	✓	- High-frequency apparatus	- Defence
			CuNi alloy	✓	- High precision equipment	- Aerospace
			Mild steel 30 HRC	✗	- Cut-back before solderin	- Aviation
			Hard steel 50 HRC Piano wire	✗	- Electrostatically sensitive compo-nents	- Laboratory

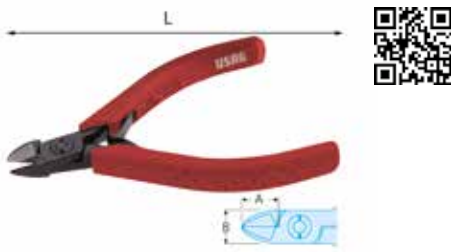

**030/3**  **ISO 9654 ASME B107.500**

**Standard nose cutting nippers with axial cutting edge**

- Rounded jaws
- Leaf interchangeable springs
- Ergonomic ABS grip, resistant to oil and solvents
- High cutting performances and easy handling
- Wire retain system

characteristics	size
CuNi capacity (mm)	Ø 0,3-1,2
Fe 30 HRC capacity (mm)	Ø 0,7
Piano wire capacity (mm)	Ø 0,5

axb mm	L mm	á gr	code	
11,5x10,5	110	60	U00300003	1



**030/4**  **ISO 9654 ASME B107.500**

**Standard cutting nippers with axial cutting edge**

- Rounded jaws
- Leaf interchangeable springs
- Ergonomic ABS grip, resistant to oil and solvents
- High cutting performances and easy handling

characteristics	size
CuNi capacity (mm)	Ø 0,3-1,4
Fe 30 HRC capacity (mm)	Ø 0,8
Piano wire capacity (mm)	Ø 0,5

axb mm	L mm	á gr	code	
11,5x10,5	110	60	U00300004	1



**030/5**  **ISO 9654 ASME B107.500**

**High capacity cutting nippers with axial cutting edge**

- Rounded jaws
- Leaf interchangeable springs
- Ergonomic ABS grip, resistant to oil and solvents
- High cutting performance and easy handling

characteristics	size
CuNi capacity (mm)	Ø 0,4-2
Fe 30 HRC capacity (mm)	Ø 1
Piano wire capacity (mm)	Ø 0,8

axb mm	L mm	á gr	code	
16x16	125	60	U00300005	1



**033/1**  **ISO 9654 ASME B107.500**

**Cutting nippers with flush cutting edge at 90°**

- Long narrow jaws for cuts in a vertical position
- Leaf interchangeable springs
- Ergonomic ABS grip, resistant to oil and solvents

characteristics	size
CuNi capacity (mm)	Ø 0,1-0,6

axb mm	L mm	á gr	code	
21x10,5	120	75	U00330001	1

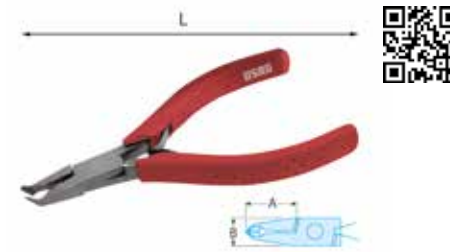

**033/2**  **ISO 9654 ASME B107.500**

**Cutting nippers with flush cutting edge at 30°**

- Long narrow jaws for cuts in an inclined position
- Leaf interchangeable springs
- Ergonomic ABS grip, resistant to oil and solvents

characteristics	size
CuNi capacity (mm)	Ø 0,2-0,6

axb mm	L mm	á gr	code	
23x11	120	65	U00330002	1



**033/3**  **ISO 9654 ASME B107.500**

**Cutting nippers with flush cutting edge at 70°**

- Long narrow jaws for cuts in an inclined position
- Leaf interchangeable springs
- Ergonomic ABS grip, resistant to oil and solvents

characteristics	size
CuNi capacity (mm)	Ø 0,2-1

axb mm	L mm	á gr	code	
12x11,5	110	65	U00330003	1

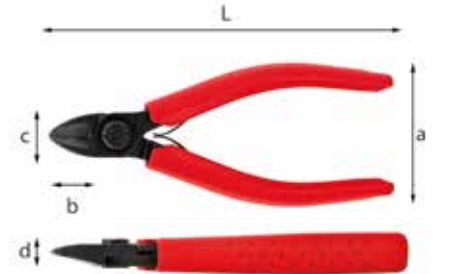

**038 AU1**  

**Diagonal cutting nippers for jewellers - for gold wire**

- Rounded head
- Flush cut
- Cutting capacity Gold: Ø 0,3÷0,8 mm
- Cutting capacity Copper: Ø 0,3÷2 mm
- Leaf interchangeable springs
- Arnitel handles resistant to oil and solvents
- Special steel body
- Phosphatized finish

L mm	a mm	b mm	c mm	d mm	á gr	code	
130	52	19	16	8	94	U00380001	1

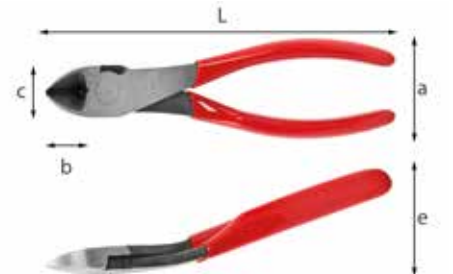

**038 AU2**  

**Cutting nippers for jewellers bent at 30° with diagonal cutting edge**

- Rounded head
- Flush cut
- Cutting capacity Gold: Ø 2,5 mm max
- Handles sheathed in PVC
- Special steel body
- Phosphatized finish, polished head

L mm	a mm	b mm	c mm	e mm	á gr	code	
180	47	22	25	41	218	U00380002	1



**040/1A**

**Tweezers with strong rigid tips**

- Acid-resistant and anti-magnetic stainless steel

L mm	code	
125	U00400002	1



**040/2A**

**Tweezers with flat rounded tips**

- Acid-resistant and anti-magnetic stainless steel

L mm	code	
115	U00400007	1

### 040/3

#### Tweezers with fine tips

- Acid-resistant and anti-magnetic stainless steel

L mm	code	
117	U00400010	1

### 040/35A

#### Tweezers with broad tips

- Acid-resistant and anti-magnetic stainless steel

L mm	code	
123	U00400025	1

### 040/5

#### Tweezers with extra-fine tips

- Acid-resistant and anti-magnetic stainless steel

L mm	code	
110	U00400016	1

### 040/5A

#### Tweezers with extra-fine angled tips

- Acid-resistant and anti-magnetic stainless steel

L mm	code	
115	U00400019	1

### 040/7

#### Tweezers with extra-fine curved tips

- Acid-resistant and anti-magnetic stainless steel

L mm	code	
120	U00400022	1

### 040 SE6

#### Set of six tweezers

- (040/1A-040/2A-040/3-040/5-040/5A-040/7)  
 - Acid-resistant and anti-magnetic stainless steel  
 - Supplied in plastic pouch

pcs	description	item/size
1	Tweezers with strong rigid tips	040/1A
1	Tweezers with flat rounded tips	040/2A
1	Tweezers with fine tips	040/3
1	Tweezers with extra-fine tips	040/5
1	Tweezers with extra-fine angled tips	040/5A
1	Tweezers with extra-fine curved tips	040/7
1	Empty pouch	372 SEV6

à gr	code	
150	U00400081	1

### 041

#### Tweezers with long rigid tips

- Acid-resistant stainless steel body  
- Polished finish

L mm	code	
160	U00410001	1

### 042

#### Tweezers with straight tips and guide pin

- Knurled gripping surface  
- Acid-resistant stainless steel  
- Polished finish

L mm	code	
150	U00420001	1

### 042 P

#### Tweezers with tips at 45° and guide pin

- Knurled gripping surface  
- Acid-resistant stainless steel body  
- Polished finish

L mm	code	
150	U00420011	1

### 045 N

#### Tweezers with straight crossed self-locking tips

- Knurled gripping surface  
- Stainless steel body  
- Polished finish

L mm	code	
160	U00450002	1

### 046

#### Flexible pick-up claw tool

- Retractable 3-arms claw with push-button control

L mm	ø max mm	a mm	code	
360	20	20	U00460035	1
500	20	20	U00460050	1
710	20	20	U00460070	1

### 046 L

#### Magnetic pick-up tool with LED light

- 4-arms claw  
- LED light activates and advances with push-button  
- Magnetic tip to retrieve small metal pieces  
- Flexible rod, Chrome plated steel

characteristics	size
Type and number of LED	1 Power LED
Brightness (lm/lx)	7 / 100
Battery type (supplied)	3 x LR44
Autonomy min-max (hours)	8
Lamp protection level	IP 54
Operating temperature (°C)	-20 ÷ + 50

L mm	opening max ø mm	capacity max Kg	code	
670	17	2	U00460001	1

### 053 N

#### Spring puller

- Hook- and fork-shaped extremities  
- Steel body sheathed in PVC

L mm	code	
200	U00530003	1

### 054

#### Pen oiler

- Push-button for precision dosing  
- Body in transparent plastic with pocket clip

L mm	capacity cm³	code	
140	5	U00540001	1

### 056

#### Rigid mirror

- Plastic body

L mm	ø mm	code	
170	25	U00566001	5

### 056/1

#### Articulated mirror

- Telescopic brass rod with pocket clip

L max mm	L min mm	ø mm	code	
690	200	38	U00560002	2





**056 L**

**Telescopic articulated mirror with LED light**

- Glass mirror resistant to scratches
- Plastic shock-proof board protection
- 2 LED to avoid shadows on the inspection zone
- Double adjustable articulation
- Extensible stainless steel body
- Antislip handle
- External diameter (frame included): 75 mm
- Internal diameter (mirror): 51 mm

L max mm	L min mm	Ø mm	h gr	code	
875	280	51	86	U00560001	1



**060/100**

**Butane gas soldering iron**

- Model complete with spare nozzle and protection cap
- Supplied with thin tip CT-01
- Ignition with Piezo system
- Charge endurance (at medium regulation): 120 minutes
- Charge capacity: 20 ml
- Supplied without gas

power W	temperature max °C	h gr	code	
100	500	140	U00600005	1



**060 R**

**Spare thin tip**

- For soldering irons 060/100

power W	code	
100	U00600011Q	1



**060 K**

**Kit with butane gas soldering iron**

- Supplied with soldering iron 060/100, spare nozzle, protection cap, four different tips and roll of Tin alloy 60/40 with antioxidant

LxPxH mm	h gr	code	
275x170x45	250	U00600008	1



**060 KR**

**Spare tips**

- For kit butane soldering iron 060 K

n°	description	code	
1	Thin tip (3,2 mm)	U00600012Q	1
2	Cutting tip	U00600014Q	1
3	Blowing tip	U00600015Q	1
4	Nozzle	U00600018Q	1



**061 W**

**Electronic pen-type soldering irons**

- Professional soldering irons for Tin
- Perfect for different applications on electrotechnical field
- Steel tips for long service life
- Housing in plastic material resistant to oils and hydrocarbons
- Power supply 230V
- Supplied with bench holder

power W	temperature max °C	h gr	code	
15	396	30	U00610022	1
20	495	30	U00610023	1
25	495	30	U00610024	1



**063 W**

**Electronic pen-type soldering iron, double power**

- Professional soldering iron for Tin
- Push-button switch
- Perfect for different applications on electrotechnical field
- Steel tip for long service life
- Housing in plastic material resistant to oils and hydrocarbons
- Power supply 230V
- Supplied with bench holder

power W	temperature max °C	h gr	code	
15÷25	495	30	U00630002	1



**061 WR1**

**Spare tip**

- For soldering irons 061 W and 063 W

code	
U00610001Q	1



**065 C**

**Suction desoldering pump**

- Antistatic tip in teflon: code 839.E1J5
- Black thin antistatic tip: code 839.EJ5

L mm	Ø tip mm	code	
200	2,4	U00650001	2



**066 N** CE 2004/108/EC - 2006/95/EC

**Quick-heating soldering iron**

- Pistol-grip model
- Straight long-life tip
- Heating time: 20 sec
- Power supply 230 V
- Cable length: 1,5 m

power W	temperature max °C	code	
150	450	U00660001	1



**066 NR**

**Spare tip**

- For soldering irons 066 N

power W	code	
150	U00660001Q	1



**068 W** CE

**High-power soldering iron 80W**

- Supplied with straight tip 068 WR1
- Removable Copper tip
- ON/OFF button
- Time to reach 280° C: 8 minutes
- MAX temperature reaching time: 20 minutes
- Diameter of metal tube: 18 mm
- Shape designed for maximum accessibility
- Ergonomic handle
- Power supply 230V
- Table support included
- Size of the soldering iron: 450x127x52 mm

characteristics	size
Power max (W)	80
Temperature max (°C)	400
Power supply (V)	230

LxPxH mm	h gr	code	
450x172x52	150	U00680010	1



**068 WR1**

**Spare tip**

- For soldering iron 068 W 80
- Diameter 12,7 mm
- Total length 129,5 mm

power W	code	
80	U00680005Q	1



**073** CE

**Insulating tape**

- Self-extinguishing PVC

size (mm x m)	code	
15x10	U00730001	10
19x25	U00730002	10



## 074 A CE □

### SMART digital multimeter

- SMART function: automatically selects AC/DC voltage, resistance, frequency
- AC/DC measurement
- Resistance and continuity measurements (acoustic sound if circuit resistance is lower than 40 to  $\Omega$ )
- Frequency measurements
- AC/DC current measurement with 076 P ammeter
- HOLD key: locks the displayed value
- MAX/MIN key: to display the minimum and maximum value between the measured data
- Digital display with backlight
- Automatic switch off after 15 minutes
- Battery charge status indicator
- Supplied with a pair of insulated tips and case
- CAT III 600 V

characteristics	size
Direct voltage DC (mV÷V)	1÷600
Alternating voltage AC (mV÷V)	1÷600
Resistance ( $\Omega$ ÷M $\Omega$ )	0÷10
Frequency kHz	3÷40
Battery type (supplied)	2xAAA

LxPxH mm	g	code	
152x72x45	230	U00740001	1



## 076 A CE □

### Professional Digital Multimeter

- Measures voltage and current AC/DC, frequency, resistance
- Continuity and diodes test
- Duty cycle indication
- Automatic calibration
- Data-hold
- Relative mode
- Supplied with a pair of insulated tips
- Spare parts (not included in the package):  
Kit fuses (2 pieces): 711A-F  
Spare tips (2 pieces): 711A-L
- CAT III 600 V

characteristics	size
Direct voltage DC (mV÷V)	400÷600
Alternating voltage AC (V÷V)	4÷600
Direct current DC ( $\mu$ A÷mA)	400÷10
Alternating current AC ( $\mu$ A÷A)	400÷10
Resistance ( $\Omega$ ÷M $\Omega$ )	400÷40
Capacity (nF÷ $\mu$ F)	40÷100
Frequency (Hz÷kHz)	10÷100
Response in frequency Hz	40÷400
Overload protection DC/AC (V)	600
Battery type (supplied)	1x9V

g	code	
460	U00760003	1



## 076 F CE □

### Automotive digital multimeter

- Measures voltage and current AC/DC, resistance, capacity, temperature
- Continuity and diodes test
- Automatic calibration function
- Data hold
- Duty cycle indication
- Dwell angle/rpm
- Supplied with a pair of insulated tips for battery and thermocouple
- Spare parts (not included in the package):  
Kit fuses (2 pieces): 711A-F  
Spare tips (2 pieces): 711A-L
- CAT III 600 V

characteristics	size
Direct voltage DC (mV÷V)	400÷600
Alternating voltage AC (V÷V)	4÷600
Direct current DC ( $\mu$ A÷mA)	400÷400
Alternating current AC ( $\mu$ A÷mA)	400÷400
Resistance ( $\Omega$ ÷M $\Omega$ )	400÷40
Temperature with K probe	-20°C÷1000°C
DWELL	180° (2 cil) ÷ 45° (8 cil)
Measurement RPM	250÷40000
Overload protection DC/AC (V)	600
Response in frequency Hz	40÷400
Battery type (supplied)	6xAAA

g	code	
705	U00760004	1



## 076 G CE □

### Voltage tester

- Tension/continuity test
- Phase/neutral identification
- Phase rotation test
- Visible and audible indication
- Tension measuring (12V ÷ 690V)
- Ideal for verifying the absence of voltage on the inverter terminals of hybrid and electric cars
- Supplied with a pair of insulated tips
- Spare parts (not included in the package):  
Spare tips (2 pieces): 701B-L
- CAT III 600 V

characteristics	size
Direct/Alternating voltage DC/AC (mV÷V)	12÷690
Frequency kHz	50÷60
Battery type (supplied)	1x9V

g	code	
185	U00760006	1



## 1000 V 076 HYB CE □

### Digital multimeter for hybrid and electric cars

- Insulation test up to 4000 Mohm at 250V, 500V, 1000 V
- Measures AC/DC voltage and current, resistance, insulation resistance, frequency, diode, continuity
- Acoustic signal when the resistance is less than 5M $\Omega$
- Supplied with pair of tips and contact tip with crocodile clip for insulation test
- Spare parts (not included in the package):  
Kit fuses (2 pieces): 714 A-F  
Spare tips (2 pieces): 714A-L
- CAT III 600 V

characteristics	size
Direct voltage DC (mV÷V)	400÷600
Alternating voltage AC (mV÷V)	4÷600
Direct current DC ( $\mu$ A÷mA)	40÷400
Alternating current AC ( $\mu$ A÷A)	40÷400
Resistance ( $\Omega$ ÷M $\Omega$ )	400÷40
Overload protection DC/AC (V)	690
Response in frequency Hz	4÷100
Battery type (supplied)	6 x 1,5V AA

g	code	
620	U00760005	1



## 076 P CE □

### Ammeter

- Current AC/DC
- Manual resetting function
- Low battery indication
- Compatible with multimeters 076 A and 076 F
- CAT III 600 V

characteristics	size
Direct/Alternating current DC/AC (A÷A)	40÷600
Max jaw opening (mm)	28
Max voltage (CA rms)	600V
Response in frequency Hz	50÷60
Overload protection DC/AC (V)	600
Battery type (supplied)	1x9V

g	code	
310	U00760010	1



076 PD  

### Ammeter and digital multimeter

- Measures voltage and current AC/DC, resistance and temperature
- Continuity and diodes test
- Low battery indication
- Data-hold function
- Supplied with a pair of insulated tips and thermocouple
- Spare parts (not included in the package):
- Spare tips (2 pieces): 711A-L
- CAT III 600 V

characteristics	size
Direct voltage DC (mV÷V)	400÷600
Alternating voltage AC (V÷V)	4÷600
Direct/Alternating current DC/AC (A÷A)	400
Resistance (Ω÷MΩ)	400÷40
Continuity test	acoustic signal for resistive values lower than 30Ω
Temperature with K probe	-20°C÷1000°C
Max jaw opening (mm)	33
Battery type (supplied)	2xAAA

á gr	code	
236	U00760013	1



1000 V

077 VSE  

by 

ISO 5746 EN 60900  
ASME B107.500

### Flat extra-long nose pliers with straight jaws - 1000 V

- Knurled gripping surface
- Burnished finish
- Bimaterial layered insulation with ergonomic grip surface
- The insulation is in critical condition when the yellow layer becomes visible.
- Each one is tested according to the European standard EN 60900 to ensure safe work

L mm	a mm	á gr	code	
165	50	170	U00770104	1



1000 V

079 EX   

ISO 5745 EN 60900

### Round nose pliers with long straight jaws - 1000 V

- Used mainly for eyelet curvature
- Smooth jaws
- Open hinge with forged joint
- Insulated ergonomic bimaterial grip
- Hanging holes at the ends for safety lock systems
- Protective enamelled finish
- Each one is tested according to the European standard EN 60900 to ensure safe work
- IMQ Certification

L mm	a mm	code	
160	52	U00790103	1



1000 V

079 VSE  

by 

### Round long nose pliers with straight jaws - 1000 V

- Knurled gripping surface
- Burnished finish
- Bimaterial layered insulation with ergonomic grip surface
- The insulation is in critical condition when the yellow layer becomes visible.
- Each one is tested according to the European standard EN 60900 to ensure safe work

L mm	a mm	á gr	code	
170	45	175	U00790105	1



1000 V

081 EX   

ISO 5745 EN 60900

### Half-round extra-long nose pliers with straight jaws - 1000 V

- Suitable for gripping and cutting operations in precision engineering
- Pointed nose with knurled gripping surface
- Additional induction hardening on cutting edges
- Ideal to cut soft, semi-hard and hard wire
- Open hinge with forged joint
- Insulated ergonomic bimaterial grip
- Hanging holes at the ends for safety lock systems
- Protective enamelled finish
- Each one is tested according to the European standard EN 60900 to ensure safe work
- IMQ Certification

L mm	1600 N/mm <sup>2</sup> ø max mm	a mm	code	
160	1,6	50	U00810103	1
200	1,6	75	U00810105	1



1000 V

D 081 EX   

ISO 5745 EN 60900

### Half-round extra-long nose pliers with straight jaws - 1000 V

L mm	1600 N/mm <sup>2</sup> ø max mm	code	
160	1,6	U00810103D	1



1000 V

081 EXP   

EN 60900

### Half-round extra-long nose pliers with jaws at 45° - 1000 V

- Suitable for gripping and cutting operations in precision engineering
- Pointed nose with knurled gripping surface
- Additional induction hardening on cutting edges
- Ideal to cut soft, semi-hard and hard wire
- Open hinge with forged joint
- Insulated ergonomic bimaterial grip
- Hanging holes at the ends for safety lock systems
- Protective enamelled finish
- Each one is tested according to the European standard EN 60900 to ensure safe work
- IMQ Certification

L mm	1600 N/mm <sup>2</sup> ø max mm	a mm	code	
160	1,6	44	U00810113	1
200	1,6	71	U00810115	1

1000 V

077 EX   

ISO 5745 EN 60900

### Flat extra-long nose pliers with straight jaws - 1000 V

- Knurled gripping surface
- Open hinge with forged joint
- Insulated ergonomic bimaterial grip
- Hanging holes at the ends for safety lock systems
- Protective enamelled finish
- Each one is tested according to the European standard EN 60900 to ensure safe work
- IMQ Certification

L mm	a mm	code	
160	50	U00770103	1
200	75	U00770105	1

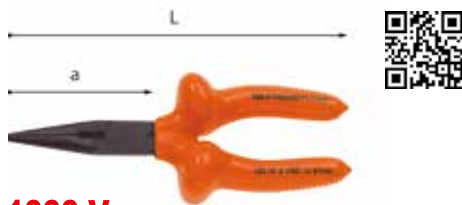

**1000 V**  
**081 VSE** by **FACOM**  
**ISO 5745 ASME B107.500**

**Half-round extra-long nose pliers with straight jaws - 1000 V**

- Knurled gripping surface
- Burnished finish
- Bimaterial layered insulation with ergonomic grip surface
- The insulation is in critical condition when the yellow layer becomes visible.
- Each one is tested according to the European standard EN 60900 to ensure safe work

L mm	a mm	Ø Cu max mm	Ø max mm 1400 N/mm <sup>2</sup>	g gr	code	
170	50	-	1,6	180	U00810104	1
200	69	3	2	250	U00810108	1



**1000 V**  
**081 VSE P** by **FACOM**  
**ISO 5745 ASME B107.500**

**Half-round extra-long nose pliers with jaws at 45° - 1000 V**

- Model with cutter for hard wire
- Knurled gripping surface
- Burnished finish
- Bimaterial layered insulation with ergonomic grip surface
- The insulation is in critical condition when the yellow layer becomes visible.
- Each one is tested according to the European standard EN 60900 to ensure safe work

L mm	a mm	Ø Cu max mm	g gr	code	
200	64	3,5	250	U00810118	1



**1000 V**  
**082 EX** **EN 60900**

**Wire strippers - 1000 V**

- For single-pole and multi-wire conductors with insulated thin wires
- Screw for regulating stripping depth
- Open hinge with forged joint
- Insulated ergonomic bimaterial grip
- Hanging holes at the ends for safety lock systems
- Protective enamelled finish
- Each one is tested according to the European standard EN 60900 to ensure safe work
- IMQ Certification

L mm	Ø max mm <sup>2</sup>	a mm	code	
160	7	35	U00820103	1



**1000 V**  
**082 VSE** by **FACOM**

**Wire stripper - 1000 V**

- With screw for setting stripping depth
- Burnished finish
- Bimaterial layered insulation with ergonomic grip surface
- The insulation is in critical condition when the yellow layer becomes visible.
- Each one is tested according to the European standard EN 60900 to ensure safe work

L mm	Ø max mm <sup>2</sup>	g gr	code	
170	7	200	U00820105	1



**1000 V**  
**083 VSE** by **FACOM**  
**EN 60900**

**Cable cutters for Copper and Aluminium cables - 1000 V**

- Burnished finish
- Bimaterial layered insulation with ergonomic grip surface
- The insulation is in critical condition when the yellow layer becomes visible.
- Each one is tested according to the European standard EN 60900 to ensure safe work

L mm	Ø Cu max mm	g gr	code	
230	14	510	U00830102	1
450	32	220	U00830103	1



**1000 V**  
**083 VSE A** by **FACOM**  
**EN 60900**

**Cable cutters for Copper and Aluminium cables - 1000 V**

- Rack-type model
- Forged steel blade
- Bimaterial layered insulation with ergonomic grip surface
- The insulation is in critical condition when the yellow layer becomes visible.
- Each one is tested according to the European standard EN 60900 to ensure safe work

	Ø max mm	Cu	Ø max mm <sup>2</sup>	Cu
U00820110	45	300	300/4x70	400/4x95
U00820112	52	400	400/3x150+1/70	240/4x120

L mm	g Kg	code	
260	1	U00820110	1
280	1	U00820112	1



**1000 V**  
**083 VSE B** by **FACOM**  
**EN 60900**

**Hacksaw - 1000 V**

- Model for adjustable blades 300 mm
- Screw for regulating blade tension
- Bimaterial layered insulation with ergonomic grip surface
- The insulation is in critical condition when the yellow layer becomes visible.
- Each one is tested according to the European standard EN 60900 to ensure safe work

mm blade	”	L mm	code	
300	12	470	U00830120	1



**1000 V**  
**083 VSE C** by **FACOM**  
**EN 60900**

**Knife - 1000 V**

- Model with thick blade, bent, with flat end
- Ergonomic bimaterial handle
- Supplied in a pouch
- Blade length: 60 mm
- Bimaterial layered insulation with ergonomic grip surface
- The insulation is in critical condition when the yellow layer becomes visible.
- Each one is tested according to the European standard EN 60900 to ensure safe work

L mm	g gr	code	
185	60	U00830125	1



**1000 V**  
**085 EX** **ISO 5746 EN 60900**

**Combination pliers - 1000 V**

- Nose with knurled inner surface to grip flat material
- Knurled gripping area to hold round material
- Additional induction hardening on cutting edges
- Ideal to cut soft, semi-hard and hard wire
- Open hinge with forged joint
- Insulated ergonomic bimaterial grip
- Hanging holes at the ends for safety lock systems
- Protective enamelled finish
- Each one is tested according to the European standard EN 60900 to ensure safe work
- IMQ Certification

L mm	Ø 2100 N/mm <sup>2</sup> max mm	a mm	code	
160	1,8	33	U00850109	1
180	2,0	36	U00850110	1

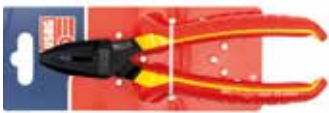

**1000 V**



**D 085 EX** **ISO 5746 EN 60900**  
**Combination pliers - 1000 V**

L mm	2100 N/mm <sup>2</sup> ø max mm	a mm	code	
180	2,0	36	U00850110D	1



**1000 V**

**085 EX/SE2**

**Assortment with combination pliers and diagonal cutting nippers - 1000 V (2 pcs.)**

pcs	description	item/size
1	Combination pliers - 1000 V	085 EX/180
1	Diagonal cutting nippers - 1000 V	087 EX/160

à gr	code	
500	U00850120	1



**1000 V**

**085 EX/SE3**

**Assortment with combination pliers, half-round nose pliers with straight jaws and diagonal cutting nippers - 1000 V (3 pcs.)**

pcs	description	item/size
1	Half-round extra-long nose pliers with straight jaws - 1000 V	081 EX/160
1	Combination pliers - 1000 V	085 EX/180
1	Diagonal cutting nippers - 1000 V	087 EX/160

à gr	code	
600	U00850121	1



**1000 V**

**085 VSE**

by **FACOM**  
**ISO 5746**

**Combination pliers - 1000 V**

- Knurled gripping surface
- Burnished finish
- Bimaterial layered insulation with ergonomic grip surface
- The insulation is in critical condition when the yellow layer becomes visible.
- Each one is tested according to the European standard EN 60900 to ensure safe work

L mm	2000 N/mm <sup>2</sup>		Cu	à gr	code	
	2000 N/mm <sup>2</sup>	1400 N/mm <sup>2</sup>				
165	1,6	2	3,3	265	U00850104	1
185	1,8	1,8	3,7	320	U00850106	1
205	2	2	4	410	U00850108	1



**1000 V**

**086 EX** **ISO 5748 EN 60900**

**End cutting nippers - 1000 V**

- Additional induction hardening on cutting edges
- Ideal to cut soft, semi-hard and hard wire
- Fulcrum closer to the cutting edge to reduce effort during cutting operations
- Open hinge with forged joint
- Insulated ergonomic bimaterial grip
- Hanging holes at the ends for safety lock systems
- Protective enamelled finish
- Each one is tested according to the European standard EN 60900 to ensure safe work
- IMQ Certification

L mm	2000 N/mm <sup>2</sup> ø max mm	a mm	code	
160	2,0	7	U00860103	1



**1000 V**

**087 EX** **ISO 5749 EN 60900**

**Diagonal cutting nippers - 1000 V**

- Lengthened and pointed head
- Clean and precise cut even on the extremities of cutting edges
- Additional induction hardening on cutting edges
- Ideal to cut soft, semi-hard and hard wire
- Fulcrum closer to the cutting edge to reduce effort during cutting operations
- Open hinge with forged joint
- Insulated ergonomic bimaterial grip
- Hanging holes at the ends for safety lock systems
- Protective enamelled finish
- Each one is tested according to the European standard EN 60900 to ensure safe work
- IMQ Certification

L mm	2200 N/mm <sup>2</sup> ø max mm	a mm	code	
140	1,4	17	U00870107	1
160	1,6	20	U00870108	1



**1000 V**

**D 087 EX** **ISO 5749 EN 60900**

**Diagonal cutting nippers - 1000 V**

L mm	2200 N/mm <sup>2</sup> ø max mm	a mm	code	
140	1,4	17	U00870107D	1
160	1,6	20	U00870108D	1



**1000 V**

**087 VSE** **EN 60900 ISO 5749**

**ASME B107.500**

**Diagonal cutting nippers - 1000 V**

- Burnished finish
- Bimaterial layered insulation with ergonomic grip surface
- The insulation is in critical condition when the yellow layer becomes visible.
- Each one is tested according to the European standard EN 60900 to ensure safe work

L mm	2000 N/mm <sup>2</sup> ø max mm	à gr	code	
145	1,4	210	U00870102	1
165	1,6	270	U00870104	1
185	1,8	370	U00870106	1



**1000 V**

**088 EX**

**ISO 5749 EN 60900**

**Heavy-duty diagonal cutting nippers - 1000 V**

- Rounded head to cut also perpendicularly on flat surfaces
- Clean and precise cut even on large diameters
- Additional induction hardening on cutting edges
- Ideal to cut soft, semi-hard and hard wire
- Fulcrum closer to the cutting edge to reduce effort during cutting operations
- Open hinge with forged joint
- Insulated ergonomic bimaterial grip
- Hanging holes at the ends for safety lock systems
- Protective enamelled finish
- Each one is tested according to the European standard EN 60900 to ensure safe work
- IMQ Certification

L mm	2000 N/mm <sup>2</sup> ø max mm	a mm	code	
160	2,0	18	U00880107	1
180	2,2	18	U00880108	1

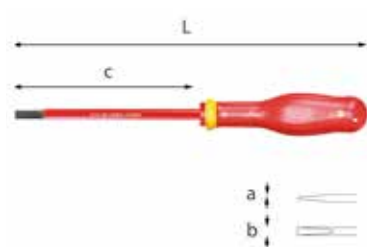

**1000 V**

**091**

**ISO 2380 EN 60900**

**Screwdrivers for slot-head screws - 1000 V**

- Silicon, Manganese and Molybdenum steel blade with phosphatized finish
- Insulated ergonomic three-material grip with soft coating, resistant to oils and chemicals
- Colour code on the handle to identify the different shapes
- Each screwdriver is tested according to the European standard EN 60900 to guarantee safe working
- IMQ Certification

axbxc mm	L mm	handle size	code	
0,4x2,5x50	144	M0	U00910003	5
0,4x2,5x75	169	M0	U00910004	5
0,5x3x75	179	M1	U00910005	5
0,5x3x100	202	M1	U00910006	5
0,6x3,5x75	179	M1	U00910007	5
0,6x3,5x100	204	M1	U00910008	5
0,8x4x100	209	M2	U00910009	5
0,8x4x150	259	M2	U00910010	5
1x5,5x125	234	M2	U00910011	5
1x5,5x150	259	M2	U00910012	5
1,2x6,5x150	270	M3	U00910013	5
1,2x8x150	275	M4	U00910014	5
1,6x10x200	325	M4	U00910015	1



**1000 V**

**D 091**

**ISO 2380 EN 60900**

**Screwdrivers for slot-head screws - 1000 V**

axbxc mm	L mm	code	
0,4x2,5x75	169	U00910004D	1
0,5x3x75	179	U00910005D	1
0,6x3,5x100	204	U00910008D	1
0,8x4x100	209	U00910009D	1
1x5,5x125	234	U00910011D	1
1,2x6,5x150	270	U00910013D	1



**1000 V**

**091 SE4**

**Set of 4 screwdrivers for slot-head screws - 1000 V**

pcs	description	item/size
4	Screwdrivers for slot-head screws - 1000 V / 0,5x3x75-0,8x4x100-1x5,5x125-1,2x6,5x150	091

gr	code	
260	U00910110	1

## 1000V INSULATED TOOLS

A complete range for all interventions on electricity

**USAG RANGE:**



**FACOM by USAG RANGE COLOUR-CODING = SAFETY**



**ORANGE** : 1000 Volts protection



**YELLOW VISIBLE** : STOP and change tool



**TOOLS IN ACCORDANCE WITH THE REQUIREMENTS OF EN60900 STANDARDS**

each tool is individually tested to 10,000 volts for 10 seconds at the end of manufacturing cycle

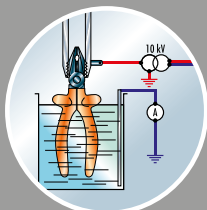

Dielectric test

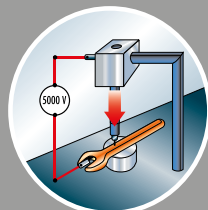

Penetration test

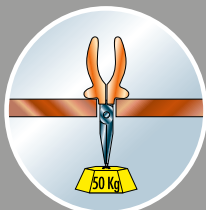

Insulation adhesion test

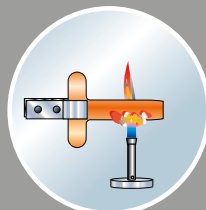

Non-flammability test

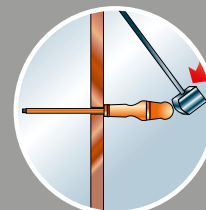

Impact test

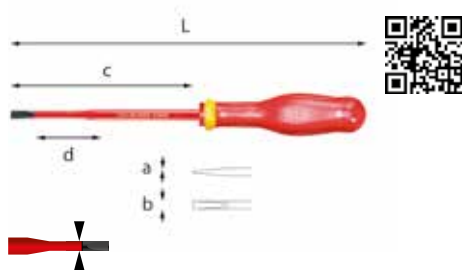

**1000 V USAG SLIM**

**091 D**

ISO 2380 EN 60900

**SLIM Screwdrivers for slot-head screws - 1000 V**

- Thin blade sheath that do not increases shaft diameter
- Silicon, Manganese and Molybdenum steel blade with phosphatized finish
- Insulated ergonomic three-material grip with soft coating, resistant to oils and chemicals
- Colour code on the handle to identify the different shapes
- Each one is tested according to the European standard EN 60900 to ensure safe work
- IMQ Certification

axbxc mm	d mm	L mm	handle size	code	
0,6x3,5x100	25	204	M1	U00910067	1
0,8x4x100	25	209	M2	U00910068	1
1x5,5x125	25	234	M2	U00910070	1
1,2x6,5x150	25	270	M3	U00910072	1

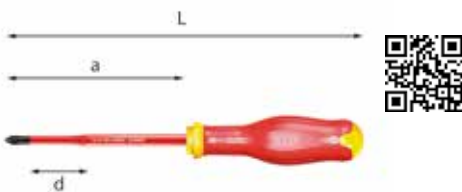

**1000 V USAG SLIM**

**091 DPH**

ISO 8764 EN 60900

**SLIM screwdrivers for PHILLIPS® screws - 1000 V**

- Thin blade sheath that do not increases shaft diameter
- Silicon, Manganese and Molybdenum steel blade with phosphatized finish
- Insulated ergonomic three-material grip with soft coating, resistant to oils and chemicals
- Colour code on the handle to identify the different shapes
- Each one is tested according to the European standard EN 60900 to ensure safe work
- IMQ Certification

n°xa	d mm	L mm	handle size	code	
1x100	25	209	M2	U00910085	1
2x125	25	245	M3	U00910087	1



**1000 V**  
**091 D/SH5**

**Set of 5 SLIM screwdrivers for slot-head and PHILLIPS® screws - 1000 V**

pcs	description	item/size
3	SLIM Screwdrivers for slot-head screws - 1000 V /0,6x3,5x100-0,8x4x100-1x5,5x125	091 D
2	SLIM screwdrivers for PHILLIPS® screws - 1000 V /1x100-2x125	091 DPH

i gr	code	
440	U00910119	1

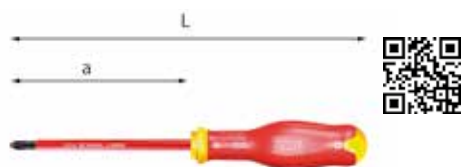

**1000 V**  
**091 PH**

ISO 8764 EN 60900

**Screwdrivers for PHILLIPS® screws - 1000 V**

- Silicon, Manganese and Molybdenum steel blade with phosphatized finish
- Insulated ergonomic three-material grip with soft coating, resistant to oils and chemicals
- Colour code on the handle to identify the different shapes
- Each one is tested according to the European standard EN 60900 to ensure safe work
- IMQ Certification

n°xa	L mm	handle size	code	
0x75	179	M1	U00910023	5
1x100	209	M2	U00910025	5
2x125	245	M3	U00910027	5
3x150	275	M4	U00910029	5
4x200	325	M4	U00910031	1



**D 091 PH**

ISO 8764 DIN 5260

**Screwdrivers for PHILLIPS® screws - 1000 V**

n°xa	L mm	code	
0x75	179	U00910023D	1
1x100	209	U00910025D	1
2x125	245	U00910027D	1
3x150	275	U00910029D	1

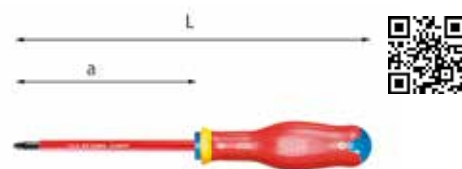

**1000 V**  
**091 PZ**

ISO 8764 EN 60900

**Screwdrivers for POZIDRIV® - SUPADRIV® screws - 1000 V**

- Silicon, Manganese and Molybdenum steel blade with phosphatized finish
- Insulated ergonomic three-material grip with soft coating, resistant to oils and chemicals
- Colour code on the handle to identify the different shapes
- Each one is tested according to the European standard EN 60900 to ensure safe work
- IMQ Certification

n°xa	L mm	handle size	code	
0x75	179	M1	U00910040	1
1x100	209	M2	U00910042	1
2x125	245	M3	U00910044	1
3x150	275	M4	U00910046	1



**1000 V**  
**091 SH5**

**Set of 5 screwdrivers for slot-head and PHILLIPS® screws - 1000 V**

pcs	description	item/size
3	Screwdrivers for slot-head screws - 1000 V /0,5x3x75-0,8x4x100-1x5,5x125	091
2	Screwdrivers for PHILLIPS® screws - 1000 V /1x100-2x125	091 PH

i gr	code	
440	U00910100	1



**1000 V**  
**091 SH6**

**Set of 6 screwdrivers for slot-head and PHILLIPS® screws - 1000 V**

pcs	description	item/size
3	Screwdrivers for slot-head screws - 1000 V /0,4x2,5x75-0,8x4x100-1x5,5x125	091
3	Screwdrivers for PHILLIPS® screws - 1000 V /0x75-1x100-2x125	091 PH

i gr	code	
486	U00910103	1



**1000 V**

**091 SH8**



**Set of 8 screwdrivers for slot-head and PHILLIPS®, POZIDRIV® - SUPADRIV® screws - 1000 V**

pcs	description	item/size
4	Screwdrivers for slot-head screws - 1000 V / 0,5x3x75-0,8x4x100-1x5,5x125-1,2x6,5x150	091
2	Screwdrivers for PHILLIPS® screws - 1000 V / 1x100-2x125	091 PH
2	Screwdrivers for POZIDRIV® - SUPADRIV® screws - 1000 V / 1x100-2x125	091 PZ

gr	code	img
740	U00910106	

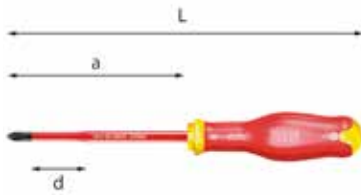

**1000 V USAG SLIM**

**091 DPHB**

**EN 60900**

**SLIM screwdrivers for combined shape for slot-head and PHILLIPS® screws - 1000 V**

- Thin blade sheath that do not increases shaft diameter
- Silicon, Manganese and Molybdenum steel blade with phosphatized finish
- Insulated ergonomic three-material grip with soft coating, resistant to oils and chemicals
- Colour code on the handle to identify the different shapes
- Each one is tested according to the European standard EN 60900 to ensure safe work
- IMQ Certification

n°xa	d mm	L mm	handle size	code	img
1x100	25	209	M2	U00910094	
2x125	25	245	M3	U00910095	



**1000 V USAG SLIM**

**091 DPHB/SE2**

**Set of 2 SLIM screwdrivers for combined shape screws - 1000 V**

pcs	description	item/size
2	SLIM screwdrivers for combined shape for slot-head and PHILLIPS® screws - 1000 V / 1x100-2x125	091 DPHB

gr	code	img
250	U00910125	

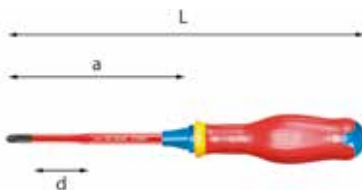

**1000 V USAG SLIM**

**091 DPZB**

**EN 60900**

**SLIM screwdrivers for combined shape for slot-head/POZIDRIV®-SUPADRIV® screws - 1000 V**

- Thin blade sheath that do not increases shaft diameter
- Silicon, Manganese and Molybdenum steel blade with phosphatized finish
- Insulated ergonomic three-material grip with soft coating, resistant to oils and chemicals
- Colour code on the handle to identify the different shapes
- Each one is tested according to the European standard EN 60900 to ensure safe work
- IMQ Certification

n°xa	d mm	L mm	handle size	code	img
1x100	25	209	M2	U00910098	
2x125	25	245	M3	U00910099	



**1000 V USAG SLIM**

**091 DPZB/SE2**

**Set of 2 SLIM screwdrivers for combined shape screws - 1000 V**

pcs	description	item/size
2	SLIM screwdrivers for combined shape for slot-head/POZIDRIV®-SUPADRIV® screws - 1000 V / 1x100-2x125	091 DPZB

gr	code	img
250	U00910126	



**1000 V**

**094 VSE**

by **FACOM**

**ISO 8976 EN 60900**

**Lay-on slip-joint adjustable pliers - 1000 V**

- 7 position model
- Safety stop for fingers always protected
- Bimaterial layered insulation with ergonomic grip surface
- The insulation is in critical condition when the yellow layer becomes visible.
- Each one is tested according to the European standard EN 60900 to ensure safe work

L mm	gr	code	img
250	360	U00940100	



**1/4**

**1000 V**

**098 1/4" E**

by **FACOM**

**ISO 2725-1 ISO 1711-1 EN**

**60900 ASME B107.5**

**Hexagonal sockets - 1000 V**

- Manual use
- Bimaterial layered insulation with ergonomic grip surface
- The insulation is in critical condition when the yellow layer becomes visible.
- Each one is tested according to the European standard EN 60900 to ensure safe work

Ø mm	b mm	L mm	gr	code	img
7	17	22	16	U00980307	
8	17	22	16	U00980308	
10	18	22	20	U00980310	



**3/8**

**1000 V**

**098 3/8" E**

by **FACOM**

**ISO 2725-1 ISO 1711-1**

**EN 60900 ASME B107.5**

**Bihexagonal sockets - 1000 V**

- Manual use
- Bimaterial layered insulation with ergonomic grip surface
- The insulation is in critical condition when the yellow layer becomes visible.
- Each one is tested according to the European standard EN 60900 to ensure safe work

Ø mm	b mm	L mm	gr	code	img
8	17	43	30	U00980208	
10	18	43	34	U00980210	
11	20	43	35	U00980211	
12	21	46	35	U00980212	
13	22	46	45	U00980213	
14	23	46	45	U00980214	





**1000 V**  
**098 3/8" L**

by **ISO 2725-1 ISO 1711-1**  
**EN 60900 ASME B107.5**

**Long bihexagonal sockets - 1000 V**

- Manual use
- Bimaterial layered insulation with ergonomic grip surface
- The insulation is in critical condition when the yellow layer becomes visible.
- Each one is tested according to the European standard EN 60900 to ensure safe work

Ø mm	b mm	L mm	h gr	code	
16	25	69	147	U00980236	1
17	27	76	147	U00980237	1
18	28	76	157	U00980238	1
19	29	76	166	U00980239	1



**1000 V**  
**098 1/2"**

by **ISO 2725-1 ISO 1711-1 EN**  
**60900 ASME B107.5**

**Bihexagonal sockets - 1000 V**

- Manual use
- Bimaterial layered insulation with ergonomic grip surface
- The insulation is in critical condition when the yellow layer becomes visible.
- Each one is tested according to the European standard EN 60900 to ensure safe work

Ø mm	b mm	L mm	h gr	code	
10	19	52	75	U00980110	1
13	23	52	75	U00980113	1
17	28	52	90	U00980117	1
19	32	52	95	U00980119	1
21	33	52	130	U00980121	1
22	34	52	145	U00980122	1



**1000 V**  
**098 1/2" L**

by **ISO 2725-1 ISO 1711-1**  
**EN 60900 ASME B107.5**

**Bihexagonal sockets - 1000 V**

- Manual use
- Bimaterial layered insulation with ergonomic grip surface
- The insulation is in critical condition when the yellow layer becomes visible.
- Each one is tested according to the European standard EN 60900 to ensure safe work

Ø mm	b mm	L mm	h gr	code	
13	23	77	135	U00980133	1
17	28	77	161	U00980137	1
19	32	77	180	U00980139	1



**1000 V**  
**098 A 3/8"**

by **ISO 3315 EN 60900**  
**ASME B107.10**

**Reversible ratchet 3/8" - 1000 V**

- Model with 72 teeth and angle of action of 5°
- Knob-turn reversal system
- Bimaterial layered insulation with ergonomic grip surface
- The insulation is in critical condition when the yellow layer becomes visible.
- Each one is tested according to the European standard EN 60900 to ensure safe work

L mm	b mm	h gr	code	
180	50	250	U00980250	1



**1000 V**  
**098 A 1/2"**

by **ISO 3315 EN 60900**  
**ASME B107.10**

**Reversible ratchet 1/2" - 1000 V**

- Model with 72 teeth and angle of action of 5°
- Knob-turn reversal system
- Bimaterial layered insulation with ergonomic grip surface
- The insulation is in critical condition when the yellow layer becomes visible.
- Each one is tested according to the European standard EN 60900 to ensure safe work

L mm	b mm	h gr	code	
265	55	580	U00980150	1



**1000 V**  
**098 B 1/4"**

by **ISO 3316 EN 60900**  
**ASME B107.10**

**Extension 1/4" - 1000 V**

- Bimaterial layered insulation with ergonomic grip surface
- The insulation is in critical condition when the yellow layer becomes visible.
- Each one is tested according to the European standard EN 60900 to ensure safe work

L mm	Ø mm	h gr	code	
116	16,6	65	U00980352	1

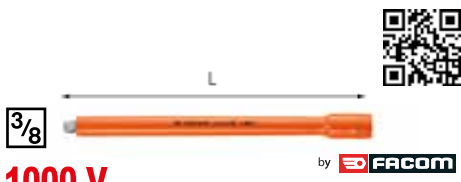

**1000 V**  
**098 B 3/8"**

by **ISO 3316 EN 60900**  
**ASME B107.10**

**Extensions 3/8" - 1000 V**

- Bimaterial layered insulation with ergonomic grip surface
- The insulation is in critical condition when the yellow layer becomes visible.
- Each one is tested according to the European standard EN 60900 to ensure safe work

L mm	Ø mm	h gr	code	
150	17	150	U00980252	1



**1000 V**  
**098 B 1/2"**

by **ISO 3316 EN 60900**  
**ASME B107.10**

**Extensions 1/2" - 1000 V**

- Bimaterial layered insulation with ergonomic grip surface
- The insulation is in critical condition when the yellow layer becomes visible.
- Each one is tested according to the European standard EN 60900 to ensure safe work

L mm	Ø mm	h gr	code	
145	22	250	U00980152	1
265	22	470	U00980153	1



**1000 V**  
**098 C 1/2"**

by **EN 60900**

**Socket holder with T handle - 1000 V**

- Bimaterial layered insulation with ergonomic grip surface
- The insulation is in critical condition when the yellow layer becomes visible.
- Each one is tested according to the European standard EN 60900 to ensure safe work

LxPxH mm	h gr	code	
210x165x25	525	U00980151	1



**1000 V**  
**098 C 3/8"**

by **EN 60900 ASME**  
**B107.10**

**Socket holder with T handle - 1000 V**

- Bimaterial layered insulation with ergonomic grip surface
- The insulation is in critical condition when the yellow layer becomes visible.
- Each one is tested according to the European standard EN 60900 to ensure safe work

LxPxH mm	h gr	code	
205x165x35	380	U00980251	1



3/8

1000 V

**USAG**  
**098 3/8" HYB8**



**Assortment for safety of hybrid and electric cars in ABS case (8 pcs.)**

- It allows you to cut out the voltage of the electrical system in order to carry out maintenance in total safety
- Sockets and ratchet allow the assembly/disassembly of the inverter cover to verify the absence of current in the capacitors
- Pliers and screwdrivers allow you to remove the plastic rivets often used to lock the plastic covers that contain the service socket
- High resistance ABS case with quick closing system
- The inside tray is studied to be stored in USAG roller cabinet drawers
- Empty inner foam module: code U05191031Q

pcs	description	item/size
1	Half-round extra-long nose pliers with straight jaws - 1000 V	081 EX/200
1	Screwdrivers for slot-head screws - 1000 V 091/1x5,5x125	
1	Screwdrivers for PHILLIPS® screws - 1000 V 091 PH/2x125	
3	Bihexagonal sockets - 1000 V / 8-10-12	098 3/8
1	Reversible ratchet 3/8" - 1000 V	098 A 3/8
1	Extensions 3/8" - 1000 V	098 B 3/8/150
1	Bi-colour foam module (empty)	519 M 098HYB8V
1	Empty ABS case - size L	606 L

LxPxH mm	code	img
435x270x70	U00980508	1



1/4

1000 V

**098 S10 1/4"**

**Assortment with hexagonal sockets in ABS case - 1000 V (10 pcs.)**

pcs	description	item/size
3	Socket bits for hex socket screws - 1000 V / 4-5-6	097 1/4
5	Hexagonal sockets - 1000 V / 6-7-8-10-12	098 1/4 E
1	Reversible ratchet 1/4" - 1000 V	098 A 1/4
1	Extension 1/4" - 1000 V	098 B 1/4/116

LxPxH mm	kg	code	img
322x136x53	650	U00980355	1



3/8

1000 V

**098 S9 3/8"**

**Assortment with bihexagonal sockets in ABS case - 1000 V (9 pcs.)**

pcs	description	item/size
6	Bihexagonal sockets - 1000 V / 8-10-11-12-13-14	098 3/8
1	Reversible ratchet 3/8" - 1000 V	098 A 3/8
2	Extensions 3/8" - 1000 V/150-260	098 B 3/8

LxPxH mm	kg	code	img
390x160x65	1,7	U00980255	1



3/8

1000 V

**098 S17 3/8"**

**Assortment with bihexagonal sockets in ABS case - 1000 V (17 pcs.)**

pcs	description	item/size
5	Bihexagonal sockets - 1000 V / 4-5-6-7-8	097 3/8
9	Bihexagonal sockets - 1000 V / 8-10-11-12-13-14-17-19	098 3/8
1	Reversible ratchet 3/8" - 1000 V	098 A 3/8
1	Extensions 3/8" - 1000 V	098 B 3/8/150
1	Socket holder with T handle - 1000 V	098 C 3/8

LxPxH mm	kg	code	img
345x280x65	2,5	U00980256	1



1/2

1000 V

**098 S12 1/2"**

**Assortment with bihexagonal sockets in ABS case - 1000 V (12 pcs.)**

pcs	description	item/size
9	Bihexagonal sockets - 1000 V / 8-9-10-11-12-13-14-17-19	098 1/2
1	Reversible ratchet 1/2" - 1000 V	098 A 1/2
2	Extensions 1/2" - 1000 V/145-265	098 B 1/2

LxPxH mm	kg	code	img
390x160x68	2,5	U00980155	1



1/2

1000 V

**098 S17 1/2"**

**Assortment with bihexagonal sockets in ABS case - 1000 V (17 pcs.)**

pcs	description	item/size
5	Chiavi a bussola per esagono incassato 1000 V/8-10-12-14-17	097 1/2
9	Bihexagonal sockets - 1000 V / 8-9-10-11-12-13-14-17-19	098 1/2
1	Reversible ratchet 1/2" - 1000 V	098 A 1/2
1	Extensions 1/2" - 1000 V	098 B 1/2/145
1	Socket holder with T handle - 1000 V	098 C 1/2

LxPxH mm	kg	code	img
345x280x65	3,4	U00980156	1



1000 V

**099 A**

**Single ended open jaw wrenches - 1000 V**

- Bimaterial layered insulation with ergonomic grip surface
- The insulation is in critical condition when the yellow layer becomes visible.
- Each one is tested according to the European standard EN 60900 to ensure safe work

a mm	L mm	kg	code	img
8	105	30	U00990108	1
9	105	35	U00990109	1
10	105	40	U00990110	1
11	115	50	U00990111	1
12	125	60	U00990112	1
13	135	70	U00990113	1
14	145	80	U00990114	1
15	145	90	U00990115	1
16	155	105	U00990116	1
17	155	120	U00990117	1
18	160	135	U00990118	1
19	165	150	U00990119	1
21	185	180	U00990121	1

**WATCH THE VIDEO**

Go to our YouTube channel or frame the QR code

YouTube



**1000 V**

**099 B** 

by 

**Offset bihexagonal ring wrenches - 1000 V**

- Bimaterial layered insulation with ergonomic grip surface
- The insulation is in critical condition when the yellow layer becomes visible.
- Each one is tested according to the European standard EN 60900 to ensure safe work

Ø mm	L mm	g	code	
8	150	50	U00990128	1
9	151	55	U00990129	1
10	157	60	U00990130	1
11	160	70	U00990131	1
12	165	100	U00990132	1
13	165	105	U00990133	1
14	180	120	U00990134	1
15	183	130	U00990135	1
16	195	160	U00990136	1
17	198	180	U00990137	1
18	215	200	U00990138	1
19	215	200	U00990139	1
21	245	300	U00990141	1



**1000 V**

**099 C** 

by   
**ISO 6787 EN 60900**  
**ASME B107.100**

**Adjustable wrenches - 1000 V**

- Head inclined at 15° with scale in millimeters
- Sliding jaw opening by rotating knurl to the left
- Burnished finish
- Bimaterial layered insulation with ergonomic grip surface
- The insulation is in critical condition when the yellow layer becomes visible.
- Each wrench is tested according to the European standard EN 60900 to ensure safe work

a mm	L mm	g	code	
27	210	385	U00990148	1
30	260	655	U00990150	1
34	310	950	U00990152	1
44	385	1935	U00990155	1



**1000 V**

**099 E** 

by   
**ISO 2936 EN 60900**

**Angled hexagon keys - 1000 V**

- Bimaterial layered insulation with ergonomic grip surface
- The insulation is in critical condition when the yellow layer becomes visible.
- Each one is tested according to the European standard EN 60900 to ensure safe work

Ø mm	L mm	g	code	
3	125	20	U00990163	1
4	125	30	U00990164	1
5	125	50	U00990165	1
6	125	70	U00990166	1
8	125	110	U00990168	1
10	125	150	U00990170	1
12	125	210	U00990172	1



**1000 V**

**099 H** 

**Insulated mats - 1000 V**

- High insulating rubber insulation mat
- It isolates the operator from the ground, in order to secure his interventions

LxPxH mm	Kg	code	
1000x600x3,2	2,5	U00990210	1
1000x1000x3,2	4,2	U00990211	1



**1000 V**

**099 I** 

by 

**Set of 4 insulated pliers - 1000 V**

- For fixing insulated mats
- Max opening: 40 mm
- Length: 155 mm

g	code	
70	U00990215	1



**1000 V**

**099 G** 

**EN 60903:2003-IEC**  
**60903:2014 DPI**  
**Categoria III**  
**(Reg EU 2016/425)**  
**IEC 61482-1-2**  
**ASTM F2675**

**Insulated gloves 1000 V**

- Bicolor composite gloves
- Integrated mechanical protection: no need of leather protector
- Arc flash rating
- Category: RC

Size	class	L mm	code	
10	0	41	U00990218	1



**1000 V**

**099 G1** 

**EN 60903:2003 -**  
**IEC 60903:2014 DPI**  
**III Categoria**  
**(Reg. EU 2016/425)**

**Insulated gloves - 1000 V**

- Natural latex - AZC class
- High dielectric strength
- Use with leather overgloves (USAG 099 G2) to ensure mechanical protection
- Chemical resistance to Acids and Ozone
- Supplied in closed anti UV envelope

Size	class	voit	L mm	thickness mm	code	
9	00	500	360	0,5	U00990200	1
10	00	500	360	0,5	U00990201	1
9	0	1000	360	0,5	U00990202	1
10	0	1000	360	0,5	U00990203	1



**1000 V**

**099 G2** 

**EN 60903**

**Safety overgloves - 1000 V**

- Protection against mechanical risks
- It is recommended to wear over insulated gloves (USAG 099 G1) to achieve mechanical and electrical protection
- Long leather sleeve for increased protection

Size	L mm	code	
9 (B)	290	U00990205	1
10 (C)	300	U00990206	1



### 099 TG

#### Pneumatic tester for insulated gloves

- Air inflator
- Recommended for field inspection before/after each use, and also for periodic visual inspection
- It makes it possible to check the whole surface of a glove, including th cuff

LxPxH mm	á gr	code	
135x125x135	504	U00990216	1



### 099 L

#### Lockout padlock

- Each padlock has its unique key, the key can open only one padlock and no others
- Captive key system: it is impossible to remove the key if the padlock is not locked
- Automatic return cylinder
- Body and shackle in composite material, UV resistant

L mm	Ø mm	á gr	code	
76	4,5	80	U00990219	1

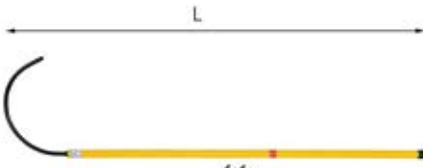

### 099 BG

#### Insulating rescue stick

- Stick for rescuing an injured technician
- Ideal for applications like hybrid cars, electrical panels and switches maintenance
- Curved steel arm
- Use in operating voltages up to 45 kV



L m	á Kg	code	
1,4	1,3	U00990221	1



### 099 FS

#### Face Shield

- Adjustable headgear and brow guardx
- Field of vision of 180°
- Transparent, no fog and scratch lens color
- Lens marking: 2C-1.2
- Chemical protection against liquid droplets or splashes, molten metals or intense radiation emissions
- Electrical short circuit protection
- Impact protection, withstands a sphere of 6 mm, 0.86 gr at 190 m / s
- 99.9% UVA / UVB protection
- Ultra enveloping: 20.5x39.4x0.18 cm

á gr	code	
315	U00990217	1



### 099 S

#### Insulating bag for connectors

- Ideal for protecting exposed electrical cables during maintenance, to prevent accidental contacts
- Transparent polyvinyl bag with velcro fastening and eyelet on one extremity

LxP mm	code	
305x225	U00990220	1



### 114 AX

ISO 5745

#### Round nose pliers with long straight jaws

- Used mainly for eyelet curvature
- Smooth jaws
- Open hinge with forged joint
- Ergonomic bimaterial grip
- Hanging holes at the ends for safety lock systems
- Chrome plated finish

L mm	a mm	code	
160	52	U01140100	1



### 115 CL

#### Double-joint plier with straight half-round jaws

- Ideal for gripping pieces and parts difficult to reach
- Pointed jaws with knurled gripping surface
- Up to 70% longer than normal long nose pliers
- Small size double joint for maximum accessibility
- Handles covered in anti-slip material

L mm	a mm	code	
340	70	U01150020	1

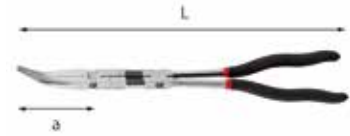

### 115 CLP

#### Double-joint pliers with half-round jaws at 45°

- Ideal for gripping pieces and parts difficult to reach
- Pointed jaws with knurled gripping surface
- Up to 70% longer than normal long nose pliers
- Small size double joint for maximum accessibility
- Handles covered in anti-slip material

L mm	a mm	code	
340	65	U01150021	1



### 115 CL/SE2

#### Double-joint pliers with half-round jaws

- Ideal for gripping pieces and parts difficult to reach
- Pointed jaws with knurled gripping surface
- Up to 70% longer than normal long nose pliers
- Small size double joint for maximum accessibility
- Handles covered in anti-slip material

pcs	description	item/size
1	Double-joint plier with straight half-round jaws	115 CL
1	Double-joint plier with half-round jaws at 45°	115 CLP

code	
U01150022	1

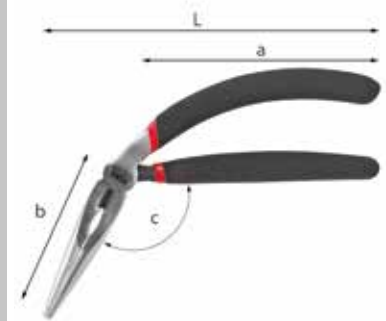

### 115 CP

#### Curved pliers with extra-long half-round jaws

- Body curved with respect to the axis of the handle for a more comfortable front grip
- Greater visibility to the task in hand
- Knurled gripping surface: length 32 mm
- Shaped jaws for perfect gripping even on round surfaces
- Integrated cutter for hard wire
- Box-joint with internal spring
- Ergonomic handles sheathed in anti-slip material

L mm	a mm	b mm	c mm	á gr	code	
170	127	73	120°	275	U01150024	1



## D 115 CP

Curved pliers with extra-long half-round jaws

L mm	a mm	b mm	c mm	â gr	code	
170	127	73	120	275	U01150024D	1

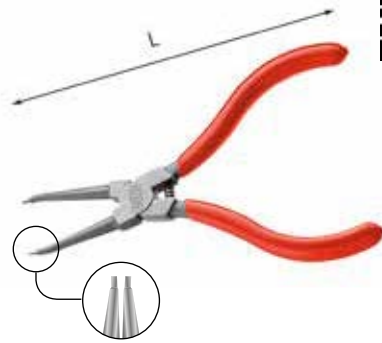

## 127 C

UNI 7914 DIN 5256

Pliers with straight nose for internal circlips

- Standard model
- Nose and tip in a single body
- Conical tips for maximum accessibility
- Handles sheathed in PVC
- Protective enamelled finish
- Return spring

capacity mm	Ø max mm	L mm	code	
12÷25	1,3	145	U01270013	5
19÷60	1,8	185	U01270014	5

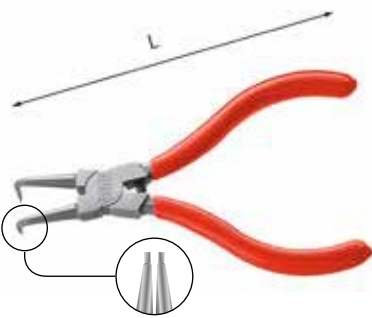

## 127 CP

UNI 7914 DIN 5256

Pliers with nose bent at 90° for internal circlips

- Standard model
- Nose and tip in a single body
- Conical tips for maximum accessibility
- Handles sheathed in PVC
- Protective enamelled finish
- Return spring

capacity mm	Ø max mm	L mm	code	
12÷25	1,3	130	U01270033	5
19÷60	1,8	170	U01270034	5

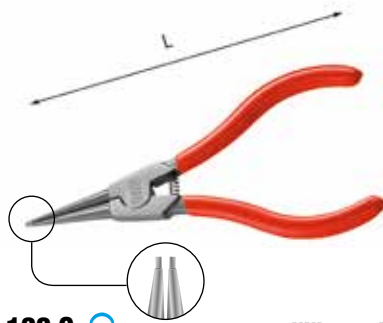

## 128 C

UNI 7914 DIN 5256

Pliers with straight nose for external circlips

- Standard model
- Nose and tip in a single body
- Conical tips for maximum accessibility
- Handles sheathed in PVC
- Protective enamelled finish
- Return spring

capacity mm	Ø max mm	L mm	code	
10÷25	1,3	150	U01280013	5
19÷60	1,8	180	U01280014	5

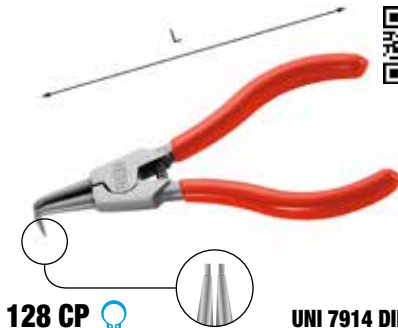

## 128 CP

UNI 7914 DIN 5256

Pliers with nose bent at 90° for external circlips

- Standard model
- Nose and tip in a single body
- Conical tips for maximum accessibility
- Handles sheathed in PVC
- Protective enamelled finish
- Return spring

capacity mm	Ø max mm	L mm	code	
10÷25	1,3	140	U01280033	5
19÷60	1,8	170	U01280034	5



## 127 C/SE4

Set of 4 pliers for circlips

pcs	description	item/size
1	Pliers with straight nose for internal circlips	127 C/19÷60
1	Pliers with nose bent at 90° for internal circlips	127 CP/19÷60
1	Pliers with straight nose for external circlips	128 C/19÷60
1	Pliers with nose bent at 90° for external circlips	128 CP/19÷60

â gr	code	
760	U01270040	1



## 127 C/SE4

Set of 4 pliers for circlips

pcs	description	item/size
1	Pliers with straight nose for internal circlips	127 C/12÷25
1	Pliers with nose bent at 90° for internal circlips	127 CP/12÷25
1	Pliers with straight nose for external circlips	128 C/10÷25
1	Pliers with nose bent at 90° for external circlips	128 CP/10÷25

â gr	code	
456	U01270045	1

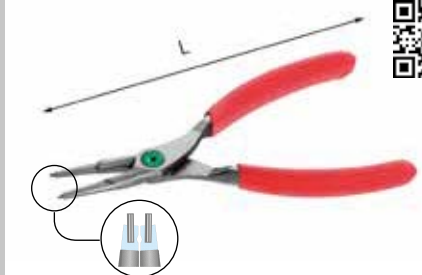

## 127 N

UNI 7914 DIN 5256

Pliers with straight nose for internal circlips

- Precision model
- Piano wire tips inserted into the nose: longer life compared to the standard tips
- Support surface of the rings between the tips and the nose
- Spring integrated in the body
- Handles sheathed in anti slip PVC
- Protective enamelled finish

capacity mm	L mm	code	
8÷13	130	U01270002	5
12÷25	140	U01270003	5
19÷60	185	U01270004	5
40÷100	220	U01270005	5
85÷200	280	U01270006	2



## D 127 N

UNI 7914 DIN 5256

Pliers with straight nose for internal circlips

capacity mm	L mm	code	
12÷25	140	U01270003D	1
19÷60	185	U01270004D	1

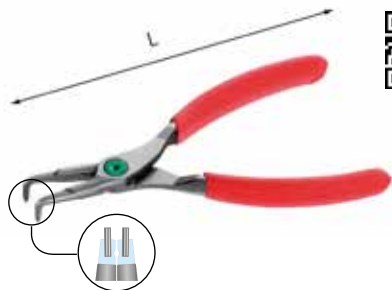

### 127 PN

UNI 7914 DIN 5256

#### Pliers with nose bent at 90° for internal circlips

- Precision model
- Piano wire tips inserted into the nose: longer life compared to the standard tips
- Support surface of the rings between the tips and the nose
- Spring integrated in the body
- Handles sheathed in anti-slip PVC
- Protective enamelled finish

capacity mm	L mm	code	
8÷13	122	U01270022	5
12÷25	130	U01270023	5
19÷60	175	U01270024	5
40÷100	205	U01270025	5
85÷200	265	U01270026	2



### D 127 PN

UNI 7914 DIN 5256

#### Pliers with nose bent at 90° for internal circlips

capacity mm	L mm	code	
12÷25	130	U01270023D	1
19÷60	175	U01270024D	1

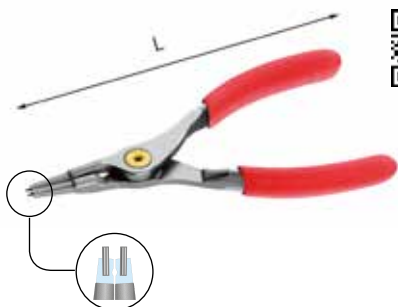

### 128 N

UNI 7915 DIN 5254

#### Pliers with straight nose for external circlips

- Precision model
- Piano wire tips inserted into the nose: longer life compared to the standard tips
- Support surface of the rings between the tips and the nose
- Spring integrated in the body
- Handles sheathed in anti-slip PVC
- Protective enamelled finish

capacity mm	L mm	code	
3÷9	140	U01280002	5
10÷25	140	U01280003	5
19÷60	180	U01280004	5
40÷100	220	U01280005	5
85÷200	310	U01280006	2



### D 128 N

UNI 7915 DIN 5254

#### Pliers with straight nose for external circlips

capacity mm	L mm	code	
10÷25	140	U01280003D	1
19÷60	180	U01280004D	1

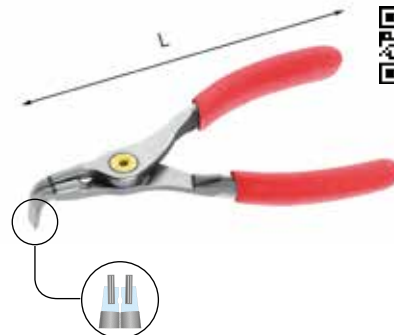

### 128 PN

UNI 7915 DIN 5254

#### Pliers with nose bent at 90° for external circlips

- Precision model
- Piano wire tips inserted into the nose: longer life compared to the standard tips
- Support surface of the rings between the tips and the nose
- Spring integrated in the body
- Handles sheathed in anti-slip PVC
- Protective enamelled finish

capacity mm	L mm	code	
3÷9	140	U01280022	5
10÷25	140	U01280023	5
19÷60	180	U01280024	5
40÷100	220	U01280025	5
85÷200	310	U01280026	2



### D 128 PN

UNI 7915 DIN 5254

#### Pliers with nose bent at 90° for external circlips

capacity mm	L mm	code	
10÷25	140	U01280023D	1
19÷60	180	U01280024D	1



### 127 N/SE4

#### Set of 4 pliers for circlips

pcs	description	item/size
1	Pliers with straight nose for internal circlips	127 N/19÷60
1	Pliers with nose bent at 90° for internal circlips	127 PN/19÷60
1	Pliers with straight nose for external circlips	128 N/19÷60
1	Pliers with nose bent at 90° for external circlips	128 PN/19÷60

g	code	
760	U01279000P	1



### 127 N/SE4S

#### Set of 4 pliers for circlips

pcs	description	item/size
1	Pliers with straight nose for internal circlips	127 N/12÷25
1	Pliers with nose bent at 90° for internal circlips	127 PN/12÷25
1	Pliers with straight nose for external circlips	128 N/10÷25
1	Pliers with nose bent at 90° for external circlips	128 PN/10÷25

g	code	
614	U01270046	1

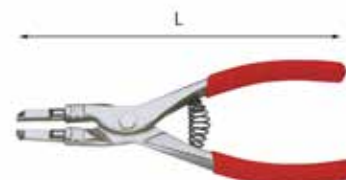

### 129

#### Pliers for external circlips

- Special jaws for working on circlips or stop rings (BNA R.92.01 standard)
- Spring-action
- Handles sheathed in PVC
- Chrome plated finish

capacity mm	L mm	code	
15÷62	190	U01290002	1



### 131 AX

ISO 5745

#### Flat extra-long nose pliers with straight jaws

- Knurled gripping surface
- Open hinge with forged joint
- Ergonomic bimaterial grip
- Hanging holes at the ends for safety lock systems
- Chrome plated finish

L mm	a mm	code	
160	50	U01310150	1
200	75	U01310151	1



### D 131 AX

ISO 5745

#### Flat extra-long nose pliers with straight jaws

L mm	code	
160	U01310150D	1



### 131 AXP

#### Flat extra-long nose pliers with jaws at 45°

- Knurled gripping surface
- Open hinge with forged joint
- Ergonomic bimaterial grip
- Hanging holes at the ends for safety lock systems
- Chrome plated finish

L mm	a mm	code	
160	44	U01310160	1



### D 131 AXP

#### Flat extra-long nose pliers with jaws at 45°

L mm	a mm	code	
160	44	U01310160D	1



### 133 AX

ISO 5745

#### Half-round extra-long nose pliers with straight jaws

- Suitable for gripping and cutting operations in precision engineering
- Pointed nose with knurled gripping surface
- Additional induction hardening on cutting edges
- Ideal to cut soft, semi-hard and hard wire
- Open hinge with forged joint
- Ergonomic bimaterial grip
- Hanging holes at the ends for safety lock systems
- Chrome plated finish

L mm	1600 N/mm <sup>2</sup> ø max mm	a mm	code	
160	1,6	50	U01330150	1
200	1,6	75	U01330151	1



### D 133 AX

ISO 5745

#### Half-round extra-long nose pliers with straight jaws

L mm	1600 N/mm <sup>2</sup> ø max mm	code	
160	1,6	U01330150D	1



### 133 AXP

#### Half-round extra-long nose pliers with jaws at 45°

- Suitable for gripping and cutting operations in precision engineering
- Pointed nose with knurled gripping surface
- Additional induction hardening on cutting edges
- Ideal to cut soft, semi-hard and hard wire
- Open hinge with forged joint
- Ergonomic bimaterial grip
- Hanging holes at the ends for safety lock systems
- Chrome plated finish

L mm	1600 N/mm <sup>2</sup> ø max mm	a mm	code	
160	1,6	44	U01330160	1
200	1,6	71	U01330161	1



### D 133 AXP

#### Half-round extra-long nose pliers with jaws at 45°

L mm	1600 N/mm <sup>2</sup> ø max mm	a mm	code	
160	1,6	44	U01330160D	1
200	1,6	71	U01330161D	1



### 133 DX

ISO 5745

#### Half-round extra-long nose pliers with straight jaws

- Suitable for gripping and cutting operations in precision engineering
- Pointed nose with knurled gripping surface
- Ideal to cut soft, semi-hard and hard wire
- Open hinge with forged joint
- Handles in PVC
- Phosphatised finish

L mm	1600 N/mm <sup>2</sup> ø max mm	a mm	code	
160	1,6	50	U01330174	1
200	1,6	75	U01330175	1

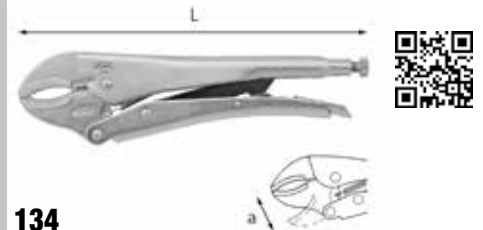

### 134

#### Lock-grip pliers with concave jaws

- Special Chrome Vanadium steel jaws
- Pressed sheet steel body
- Nickel plated finish

L mm	a mm	code	
185	28	U01340001	5
225	42	U01340002	5
300	65	U01340003	1



### D 134

#### Lock-grip pliers with concave jaws

L mm	a mm	code	
225	42	U01340002D	1

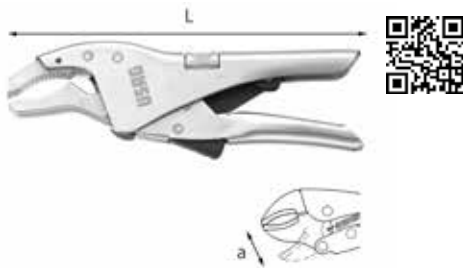

### 134 A

#### Lock-grip pliers with concave jaws

- Forged jaws
- Tothing designed for a perfect grip even on round surfaces
- Patented opening system integrated in the handles
- Roller grip adjustment integrated in the handle

L mm	a mm	code	
250	60	U01340100	1

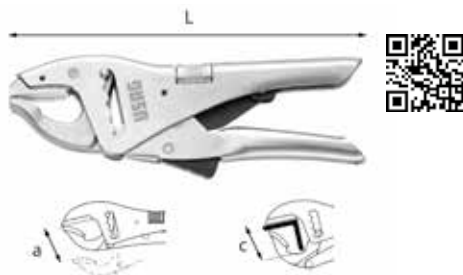

### 135 A

#### Lock-grip rack-type pliers with short jaws

- Forged jaws
- Tothing designed for a perfect grip even on round surfaces
- Patented opening system integrated in the handles
- Roller grip adjustment integrated in the handle
- 5-positions rack

L mm	a mm	c mm	code	
250	80	40	U01350505	1

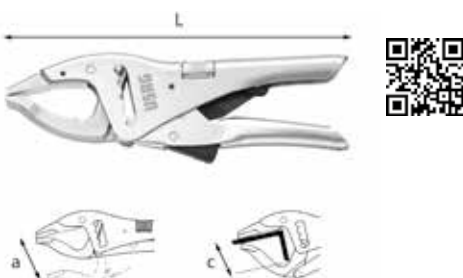

### 135 B

#### Lock-grip rack-type pliers with long jaws

- Forged jaws
- Tothing designed for a perfect grip even on round surfaces
- Patented opening system integrated in the handles
- Roller grip adjustment integrated in the handle
- 5-positions rack

L mm	a mm	c mm	code	
250	110	50	U01350510	1



### D 135 B

#### Lock-grip rack-type pliers with long jaws

L mm	a mm	c mm	code	
250	110	50	U01350510D	1

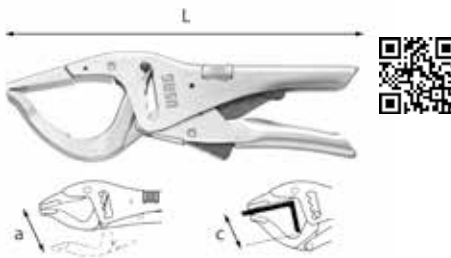

### 135 C

#### Lock-grip rack-type pliers with high capacity

- Forged jaws
- Tothing designed for a perfect grip even on round surfaces
- Patented opening system integrated in the handles
- Roller grip adjustment integrated in the handle
- 5-positions rack

L mm	a mm	c mm	code	
250	135	70	U01350530	1

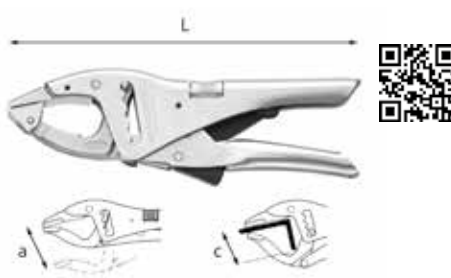

### 135 D

#### Lock-grip rack-type pliers with floating jaw

- Forged jaws
- Patented opening system integrated in the handles
- Tothing designed for a perfect grip even on round surfaces
- Roller grip adjustment integrated in the handle
- 5-positions rack

L mm	a mm	c mm	code	
250	110	50	U01350535	1

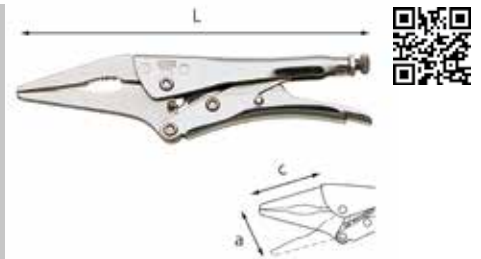

### 135 L

#### Lock-grip pliers with long thin jaws

- Special Chrome Vanadium steel jaws
- Pressed sheet steel body
- Nickel plated finish
- Jaws width: 9,5 mm

L mm	a mm	c mm	code	
235	70	80	U01350401	1

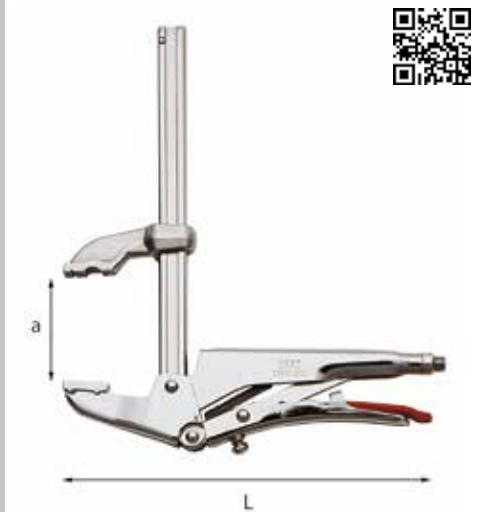

### 136 M

#### Lock-grip pliers with sliding upper jaw

- Screw for regulating parallelism between the jaws
- Special Chrome Vanadium steel jaws
- Pressed sheet steel body
- Nickel plated finish
- Accessories available on request: clamp 136 MB and jaw-covers 136 MA

a mm	L mm	code	
100	260	U01360510	1
200	260	U01360511	1

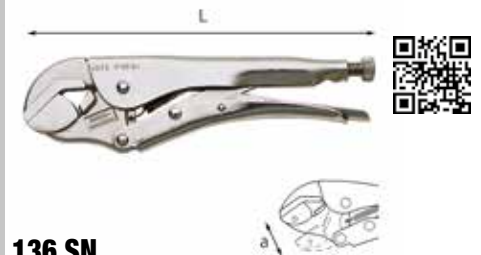

### 136 SN

#### Lock-grip pliers with articulated lower jaw

- Special Chrome Vanadium steel jaws
- Pressed sheet steel body
- Nickel plated finish

L mm	a mm	code	
235	45	U01360501	1



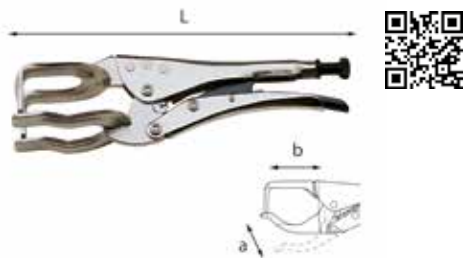

### 137 Lock-grip pliers with fork-shaped jaws

- For welding pipes, sheet steel and metal profiles
- Special Chrome Vanadium steel jaws
- Pressed sheet steel body
- Nickel plated finish

L mm	a mm	b mm	code	
280	50	80	U01370001	1

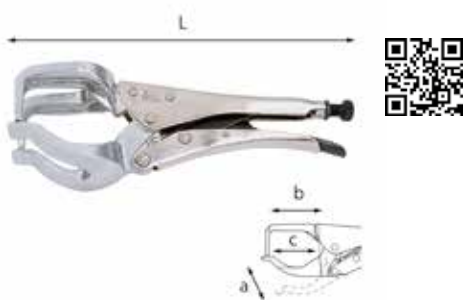

### 137 AL Lock-grip pliers with fork-shaped jaws in Aluminium

- For arc-welding pipes, sheet steel and metal profiles
- Pressed sheet steel body
- Nickel plated finish

L mm	a mm	b mm	c mm	code	
280	65	80	50	U01370201	1

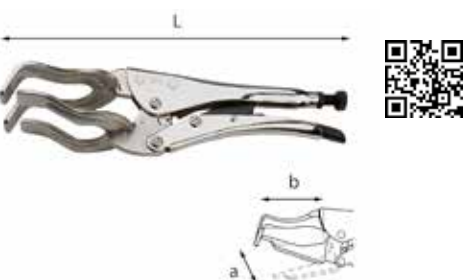

### 137 T Lock-grip pliers with fork-shaped jaws

- For welding pipes
- Special Chrome Vanadium steel jaws
- Pressed sheet steel body
- Nickel plated finish

L mm	a mm	b mm	code	
285	75	80	U01370101	1

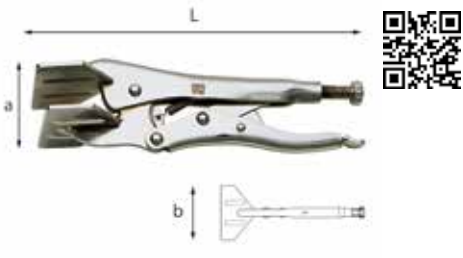

### 138 Lock-grip pliers with wide flat jaws

- For gripping flat sections
- Special Chrome Vanadium steel jaws
- Pressed sheet steel body
- Nickel plated finish

L mm	a mm	b mm	code	
200	25	80	U01380001	1

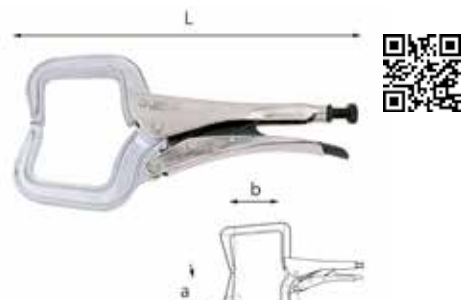

### 139 AL Lock-grip pliers with C-clamp jaws in Aluminium

- For arc-welding metal profiles and small fittings
- Pressed sheet steel body
- Nickel plated finish

L mm	a mm	b mm	code	
290	80	70	U01390101	1
350	125	120	U01390102	1

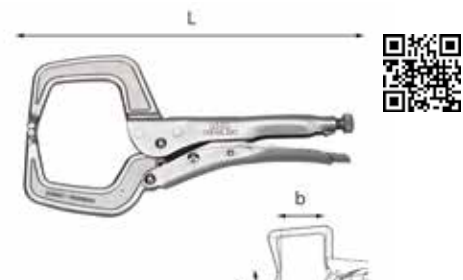

### 139 AN Lock-grip pliers with C-clamp jaws

- For gripping metal profiles and small fittings
- Special Chrome Vanadium steel jaws
- Pressed sheet steel body
- Nickel plated finish

L mm	a mm	b mm	code	
280	76	75	U01390004	1

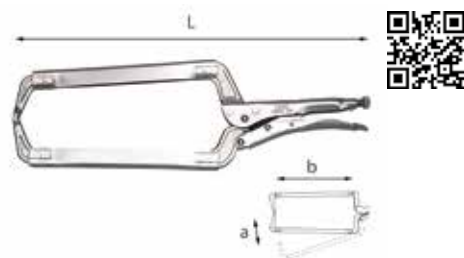

### 139 LN Lock-grip pliers with long C-clamp jaws

- For deep gripping
- Special Chrome Vanadium steel jaws
- Pressed sheet steel body
- Nickel plated finish

L mm	a mm	b mm	code	
450	260	280	U01390003	1



### 146 A Automatic wire strippers, straight

- Cutting and stripping functions for electrical wires
- Capacity 0,02-10 mm<sup>2</sup>/AWG 34-80
- Interchangeable jaws without use of tools
- Built-in wire cutter
- Precise adjustment of the stripping diameter to avoid damages
- Adjustable stripping length
- After each stripping operation, the jaw opens automatically to facilitate the extraction of the wire
- Ergonomic bimaterial handles

max mm <sup>2</sup>	max mm	L mm	code	
0,02÷10	15	191	U01460003	1



### 146 B Automatic wire strippers, bent at 90°

- Cutting and stripping functions for electrical wires
- Capacity 0,02-10 mm<sup>2</sup>/AWG 34-80
- Interchangeable jaws without use of tools
- Built-in wire cutter
- Precise adjustment of the stripping diameter to avoid damages
- Adjustable stripping length
- After each stripping operation, the jaw opens automatically: comfortable especially in case of repetitive operations on a table or workbench
- Ergonomic bimaterial handles

max mm <sup>2</sup>	max mm	L mm	code	
0,02÷10	15	110	U01460004	1

## RANGE OF PLIERS "AX": TOP PERFORMANCE

Chrome Plated Finish. Bimaterial Handles.

PAGE 58



**CUTTING EDGES WITH INDUCTION HARDENING**  
for maximum efficiency in cutting the piano wire



Can cut up to 2 mm piano wire with 30% less effort in comparison to the maximum value stated on the European rules ISO5749 (cutting nippers) - ISO5746 (pliers)

**FULCRUM CLOSER TO THE CUTTING EDGES**  
to reduce effort during cutting operations

**ERGONOMIC BIMATERIAL GRIP**

**HANGING HOLES**



YouTube

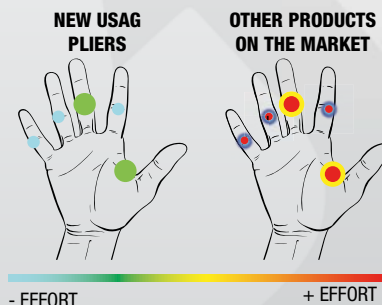

Minimum effort resulting from the studies on muscle strain made by the prestigious US Ergonomics Institute

	PLIERS				CUTTING NIPPERS		WIRE STRIPPERS
	Combina-tion	Half-round nose	Flat nose	Curved nose	Taglienti diagonali	Taglienti frontali	
<b>Range AX</b>							
	<b>150 AX</b>	<b>133 AX</b>	<b>131 AX</b>		<b>185 AX</b>		
	<b>155 AX</b>	<b>133 AXP</b>	<b>131 AXP</b>	<b>114 AX</b>	<b>188 AX</b>	<b>182 AX</b>	<b>147 AX</b>

## ADJUSTABLE PLIERS



PAGE  
**61**

### **180 B** Box-joint semiautomatic adjustable pliers

- Multi-grip jaws for round or hexagonal profiles. Hardening 62 HRC
- 12-position rack
- Ergonomic handles in high resistant plastic material
- Integrated regulation button



PAGE  
**61**

### **180 C** Box-joint adjustable pliers

- Multi-grip jaws for round or hexagonal profiles. Hardening 50 HRC
- 7-position rack
- Ergonomic handles sheathed in PVC



PAGE  
**61**

### **178 N** Lay-on slip-joint adjustable pliers

- Multi-grip jaws for round or hexagonal profiles. Hardening 49 HRC
- 8-position rack
- Ergonomic handles sheathed in PVC

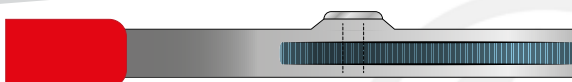

#### **BOX-JOINT**

Ensures maximum grip stability and optimum force transmission

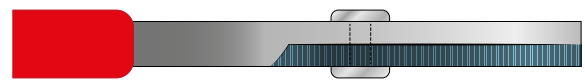

#### **SLIP-JOINT**

Allows a secure grip for most applications



1 2

### 146 R

#### Spare jaws

- Both jaws are compatible with models 146 A and 146 B
- By mounting the largest jaw on wire strippers, capacity can be easily increased

n°	max mm²	code	
1	0,02÷10	U01460003Q	1
2	4÷16	U01460004Q	1



### 147 AX

UNI 7926

#### Wire strippers

- For single-pole and multi-wire conductors with insulated thin wires
- Screw for regulating stripping depth
- Open hinge with forged joint
- Ergonomic bimaterial grip
- Hanging holes at the ends for safety lock systems
- Chrome plated finish

max mm²	L mm	a mm	code	
7	160	35	U01470150	1



### D 147 AX

UNI 7926

#### Wire strippers

max mm²	L mm	a mm	code	
7	160	35	U01470150D	1



### 148 A

#### Cable cutters for Copper and Aluminium cables

- Rack-type model
- Pressed sheet steel handles sheathed in PVC

max mm²	L mm	code	
32	260	U01480101	1
52	280	U01480102	1



### 148 AB

#### Spare fixed blade

- For cable cutters 148 A

ø max mm	code	
32	U01480111	1
52	U01480112	1



### 148 AC

#### Spare mobile blade

- For cable cutters 148 A

ø max mm	code	
32	U01480121	1
52	U01480122	1



### 148 CX

#### Cable cutters for Copper and Aluminium cables

- Special Chrome Vanadium steel
- Handles in PVC

max mm²	L mm	code	
17	230	U01480006	1



### 148 L

UNI 8791

#### Cable cutters for Copper and Aluminium cables

- Long model with handles in tubular steel
- PVC handgrips
- Spare blades with bolts: 412.L30

ø max mm	L mm	code	
32	600	U01480201	1



### 150 AX

ISO 5746

#### Combination pliers

- Nose with knurled inner surface to grip flat material
- Knurled gripping area to hold round material
- Additional induction hardening on cutting edges
- Ideal to cut soft, semi-hard and hard wire
- Open hinge with forged joint
- Ergonomic bimaterial grip
- Hanging holes at the ends for safety lock systems
- Chrome plated finish

L mm	2100 N/mm² ø max mm	a mm	code	
160	1,8	33	U01500150	1
180	2	36	U01500151	1
200	2,2	42	U01500152	1



### D 150 AX

ISO 5746

#### Combination pliers

L mm	2100 N/mm² ø max mm	a mm	code	
160	1,8	33	U01500150D	1
180	2	36	U01500151D	1
200	2,2	42	U01500152D	1



## 150 AX

#### Combination pliers



YouTube

**Hardened cutting edges**  
Maximum efficiency in cutting piano wire.

**Fulcrum closer to the cutting edges**  
Reduced effort during cutting operations

**Bimaterial handles**  
Comfort and ergonomics

**USAG PLIERS**    **OTHER PRODUCTS ON THE MARKET**

- EFFORT                      + EFFORT

Minimum effort resulting from the studies on muscle strain made by the prestigious US Ergonomics Institute



### 150 AX/SE2

Assortment with combination pliers and diagonal cutting nippers (2 pcs.)

pcs	description	item/size
1	Combination pliers	150 AX/180
1	Heavy-duty diagonal cutting nippers	188 AX/160

gr	code	
500	U01500200	1



### 150 AX/SE3

Assortment with combination pliers, extra-long half-round nose pliers and cutting nippers (3 pcs.)

pcs	description	item/size
1	Half-round extra-long nose pliers with straight jaws	133 AX/160
1	Combination pliers	150 AX/180
1	Heavy-duty diagonal cutting nippers	188 AX/160

gr	code	
660	U01500201	1



### 150 AX/SP2

Assortment with combination pliers and box-joint adjustable pliers (2 pcs.)

pcs	description	item/size
1	Combination pliers	150 AX/180
1	Box-joint adjustable pliers	180 C/250

gr	code	
600	U01500202	1



### 150 DX

ISO 5746

Combination pliers

- Nose with knurled inner surface to grip flat material
- Knurled gripping area to hold round material
- Ideal to cut soft, semi-hard and hard wire
- Open hinge with forged joint
- Handles in PVC
- Phosphatised finish

L mm	2100 N/mm <sup>2</sup> σ max mm	a mm	code	
180	2	36	U01500177	1
200	2,2	42	U01500178	1



### 150 DX/SE2

Assortment with combination pliers and diagonal cutting nippers (2 pcs.)

pcs	description	item/size
1	Combination plier	150 DX/180
1	Diagonal cutting nipper	188 DX/180

gr	code	
500	U01500213	1



### 150 DX/SE3

Assortment with combination pliers, half-round extra-long nose pliers with straight jaws and diagonal cutting nippers (3 pcs.)

pcs	description	item/size
1	Half-round extra-long nose plier with straight jaws	133 DX/160
1	Combination plier	150 DX/180
1	Diagonal cutting nipper	188 DX/160

gr	code	
610	U01500214	1



### 150 DX/SP2

Assortment with combination pliers and lay-on slip-joint adjustable pliers (2 pcs.)

pcs	description	item/size
1	Combination plier	150 DX/180
1	Lay-on slip-joint adjustable plier	178 N/250

gr	code	
600	U01500215	1



### 155 AX

Multifunction combination pliers

- Internal groove for frontal gripping of cylindrical parts
- Also designed for holding and maneuvering screws and nails
- Nose extremity with internal knurled surface for gripping flat material
- Double toothed groove for gripping round or hexagonal material
- Additional induction hardening on cutting edges
- Ideal to cut soft, semi-hard and hard wire
- Open hinge with forged joint
- Insulated ergonomic bimaterial grip
- Hanging holes at the ends for safety lock systems
- Chrome plated finish



L mm	a mm	2100 N/mm <sup>2</sup> σ max mm	code	
200	42	2,2	U01550001	1



### 157 RV

Empty holders for pliers, cutting nippers and miscellaneous tools

- Enamelled sheet steel
- Supplied without screws

n°	L mm	gr	code	
8	220	265	U01570001Q	1
14	440	665	U01570002Q	1



### 158 A

#### Safety-twist pliers

- Model with automatic spring-action
- Tapering jaws with knurled gripping surface
- Burnished finish
- Right-handed use

ø wire mm	L mm	code	
1,6	260	U01580001	1



### 160

#### Punch pliers

- Revolving model with six interchangeable punches
- Handles sheathed in PVC

ø punches mm	code	
2-2,9-3,3-3,7-4,1-4,5	U01600001	1



### D 160

#### Punch pliers

ø punches mm	code	
2-2,5-3-3,5-4-4,5	U01600001D	1



### 160 K

#### Gasket punch set

- Assortment of interchangeable punches with cutting heads suitable for the cutting of cardboard, leather, rubber, fiber, flexible plastic seals
- Supplied with:
  - 1 handle
  - 15 punches, diameter Ø 3-4-6-8-10-12-14-16-18-20-22-24-26-28-30 mm
  - 1 compass, with cutting capacity of Ø 56 ÷ 330 mm
  - 1 retractable center point

LxPxH mm	kg	code	
228x183x44	1,3	U01600080	1



### 161 A1

#### Wire stripper with adjustable blade

- Multifunctional tool for circular and longitudinal cutting
- Device for regulating cutting depth
- Supplied with spare blade

ø max mm	L mm	code	
28	134	U01610001	1



### 161 A2

#### Wire stripper with adjustable blade and cutter

- Multifunctional tool for circular and longitudinal cutting
- Device for regulating cutting depth
- Supplied with spare blade

ø mm	L mm	code	
28	206	U01610002	1



### 161 AR

#### Spare blade

- For 161 A1 and 161 A2

h gr	code	
7	U01610001Q	1



### 162

#### Adjustable cable sheath stripper

- Professional cable sheath stripper for power cables, electric cables, multi-core control cables, optical fiber and Copper multi-core cables
- Double bracket for cable positioning: higher capacity
- Allows circular, longitudinal and spiral stripping
- Supplied with blade already assembled and ready to use

ø mm	L mm	code	
4,5÷40	170	U01620001	1



### 162 R

#### Spare blades

- For cable sheath strippers 162

code	
U01620001Q	1



### 163

#### Multi-purpose cable sheath stripper

- For circular and longitudinal stripping of cables with external sheathing in PVC
- Trigger system (-30% effort): necessary pressure 75N
- Roller for regulating cutting depth
- Self rolling stripping blade
- Trigger stop when blade is out
- Safety blade stop
- Ergonomic plastic body
- Spare blade included
- Kit of spare blades code 872272



ø mm	L mm	code	
4÷28	170	U01630001	1

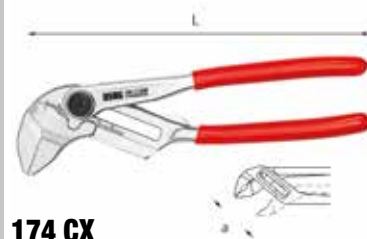

### 174 CX

#### Adjustable plier wrench

- Plier and wrench in a single product
- Allows to screw, hold, press or bend
- Flat nose to work on delicate surfaces without damages
- Parallel jaws for a perfect contact with the surfaces
- The internal design of the jaws allows to work perfectly on hexagon without damages
- Metric scale for a precise set-up
- Smooth jaws (17 mm) for the best accessibility
- 20 positions rail with push button opening
- Quick adjust closing system: not needed to press the button
- Free movement of jaws allows to work with ratcheting effect
- Forged chrome vanadium steel with chromed finishing
- PVC covered handles

L mm	a mm	code	
250	58	U01740001	1

MAX. CAPACITY  
**58 mm**

20 POSITIONS RAIL



**QUICK ADJUST CLOSING**  
without pushing the button.



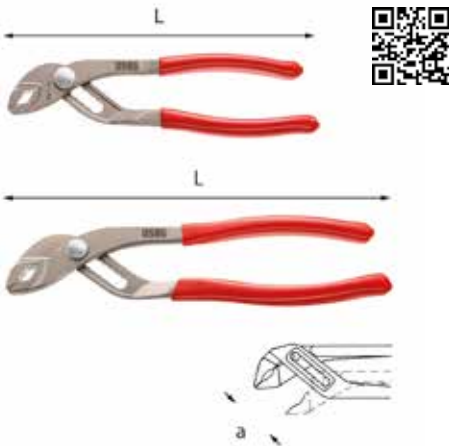

**178 N** ISO 8976

**Lay-on slip-joint adjustable pliers**

- 8-position model
- Handles sheathed in PVC
- Sandblasted enamelled finish
- Steel body
- Security block, fingers protected in every opening position

L mm	a mm	code	
180	30	U01780011	1
250	44	U01780012	1



**D 178 N** ISO 8976

**Lay-on slip-joint adjustable pliers**

L mm	a mm	code	
180	30	U01780011D	1
250	44	U01780012D	1

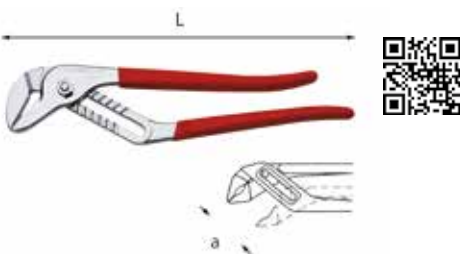

**179 L** ISO 8976

**Lay-on slip-joint adjustable pliers with channels, rack-type**

- 11-position model
- Handles sheathed in PVC
- Special Chrome Vanadium steel body
- Chrome plated finish

L mm	a mm	code	
400	90	U01790102	1

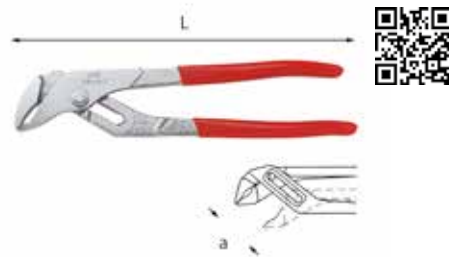

**179 N** ISO 8976

**Lay-on slip-joint adjustable pliers with channels, rack-type**

- 5-position model
- Handles sheathed in PVC
- Special Chrome Vanadium steel body
- Chrome plated finish

L mm	a mm	code	
240	42	U01790024	5

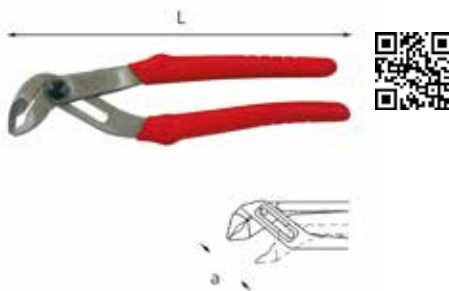

**180 B** ISO 8976

**Semiautomatic adjustable pliers**

- Integrated regulation button
- 12-position model
- Quick and precise rack
- Box-joint system
- Self-locking
- High frequency treatment of the jaws
- Steel body totally forged
- Burnished with protective enamelled finish
- Ergonomic handles studied to apply extreme force

L mm	a mm	code	
180	24	U01800030	1
250	36	U01800031	1
300	42	U01800032	1



**D 180 B** ISO 8976

**Semiautomatic adjustable pliers**

L mm	a mm	code	
250	36	U01800031D	1

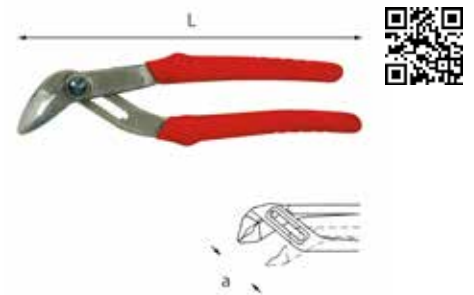

**180 BL** ISO 8976

**Long nose semiautomatic adjustable pliers**

- Long nose for exceptional accessibility
- Integrated regulation button
- 12-position model
- Quick and precise rack
- Box-joint system
- Self-locking
- High frequency treatment of the jaws
- Steel body totally forged
- Burnished with protective enamelled finish
- Ergonomic handles studied to apply extreme force

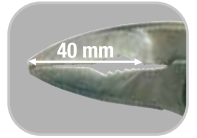

L mm	a mm	code	
250	36	U01800035	1



**180 C** ISO 8976

**Box-joint adjustable pliers**

- 7-position model
- Handles sheathed in PVC
- Special Chrome Vanadium steel body
- Enamelled finish

L mm	a mm	code	
250	36	U01800010	5
300	42	U01800011	5



**D 180 C** ISO 8976

**Box-joint adjustable pliers**

L mm	a mm	code	
250	36	U01800010D	1

## SAWS



YouTube

PAGE  
65



### 200 F Aluminium frame

- Adjustable blade with 8 different positions.
- Tension control system.
- Constant cutting capacity.

PAGE  
65



### 200 S Aluminium frame covered with ABS

- Blade swivel 45° or 90°.
- Blade tension regulator integrated in the handle.

PAGE  
65



### 200 Steel frame

- Full metal body.
- Screw for regulating blade tension.



## SCISSORS FOR ELECTRICIANS



PAGE  
**67**

### **207 E** Steel strength

- Stainless steel structure (blades and inside handles): flexural strength 180 Kg
- Cable cutter capacity 15 mm
- Weight 150 gr
- Integrated wire stripper
- Belt holder



 YouTube



PAGE  
**67**

### **207 D** The reference for electricians

- Stainless steel blades
- Glass-reinforced technopolymer handles: flexural strength 80 Kg
- Cable cutter capacity 15 mm
- Weight 90 gr
- Belt holder



 YouTube



PAGE  
**67**

### **207 C** Quality and convenience

- Titanium covered steel blades: flexural strength 60 Kg
- Cable cutter capacity 12 mm
- Weight 80 gr
- Jaws for corrugated pipes

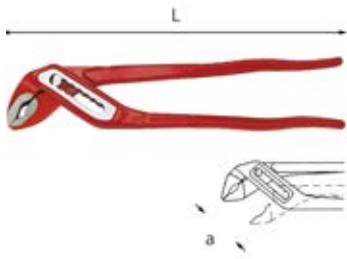

## 180 V

ISO 8976

### Box-joint adjustable pliers

- 7-position model
- Special Chrome Vanadium steel body
- Enamelled finish

L mm	a mm	code	
250	36	U01800015	5
300	42	U01800016	5



## D 180 V

ISO 8976

### Box-joint adjustable pliers

L mm	a mm	code	
250	36	U01800015D	1



## 182 AX

ISO 5748

### End cutting nippers

- Additional induction hardening on cutting edges
- Ideal to cut soft, semi-hard and hard wire
- Fulcrum closer to the cutting edge to reduce effort during cutting operations
- Open hinge with forged joint
- Ergonomic bimaterial grip
- Hanging holes at the ends for safety lock systems
- Chrome plated finish

L mm	2000 N/mm <sup>2</sup> ø max mm	a mm	code	
160	2	7	U01820151	1
200	2,5	7	U01820152	1



## D 182 AX

ISO 5748

### End cutting nippers

L mm	2000 N/mm <sup>2</sup> ø max mm	a mm	code	
160	2	7	U01820151D	1
200	2,5	7	U01820152D	1



## 185 AX

ISO 5749

### Diagonal cutting nippers

- Lengthened and pointed head
- Clean and precise cut even on the extremities of cutting edges
- Additional induction hardening on cutting edges
- Ideal to cut soft, semi-hard and hard wire
- Fulcrum closer to the cutting edge to reduce effort during cutting operations
- Open hinge with forged joint
- Ergonomic bimaterial grip
- Hanging holes at the ends for safety lock systems
- Chrome plated finish

L mm	2200 N/mm <sup>2</sup> ø max mm	a mm	code	
140	1,4	17	U01850151	1
160	1,6	20	U01850152	1



## D 185 AX

ISO 5749

### Diagonal cutting nippers

L mm	2200 N/mm <sup>2</sup> ø max mm	a mm	code	
140	1,4	17	U01850151D	1
160	1,6	20	U01850152D	1



## 185 DX

ISO 5749

### Diagonal cutting nippers

- Lengthened and pointed head
- Clean and precise cut even on the extremities of cutting edges
- Ideal to cut soft, semi-hard and hard wire
- Open hinge with forged joint
- Handles in PVC
- Protective enamelled finish

L mm	2200 N/mm <sup>2</sup> ø max mm	a mm	code	
160	1,6	20	U01850178	1

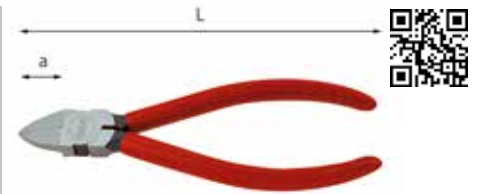

## 186 C

### Diagonal cutting nippers with flush cutting edge for plastics

- Rounded thinned jaws
- Spring-action
- Handles sheathed in PVC
- Special Chrome Vanadium steel
- Burnished finish with polished head

L mm	a mm	code	
150	22	U01860060	2
180	27	U01860061	2



## 188 AX

ISO 5749

### Heavy-duty diagonal cutting nippers

- Rounded head to cut also perpendicularly to flat surfaces
- Clean and precise cut even on large diameters
- Additional induction hardening on cutting edges
- Ideal to cut soft, semi-hard and hard wire
- Fulcrum closer to the cutting edge to reduce effort during cutting operations
- Open hinge with forged joint
- Ergonomic bimaterial grip
- Hanging holes at the ends for safety lock systems
- Chrome plated finish

L mm	2000 N/mm <sup>2</sup> ø max mm	a mm	code	
160	2,0	18	U01880151	1
180	2,2	18	U01880152	1
200	2,5	22	U01880153	1



## 188 DX

ISO 5749

### Heavy-duty diagonal cutting nippers

- Rounded head to cut also perpendicularly to flat surfaces
- Clean and precise cut even on large diameters
- Ideal to cut soft, semi-hard and hard wire
- Open hinge with forged joint
- Handles in PVC
- Phosphatised finish

L mm	2000 N/mm <sup>2</sup> ø max mm	a mm	code	
180	2,0	18	U01880179	1



### 190 I

ISO 5747

#### Toggle joint diagonal cutting nippers

- For piano wire, with knee-type joint to reduce cutting effort
- Pressed sheet steel handles, sheathed in PVC
- Polished Nickel plated and burnished finish

L mm	2000 N/mm <sup>2</sup> ø max mm	a mm	code
160	2	16	U01900101



### 191

#### Cable cutter for steel cables

- Model for round steel cables and strands
- PVC handles
- Burnished finish

L mm	2000 N/mm <sup>2</sup> ø max mm	1600 N/mm <sup>2</sup> ø max mm	code
165	1,5	5	U01910001

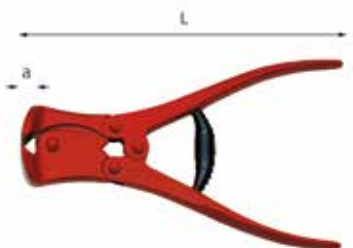

### 194

ISO 5748

#### Toggle joint end cutting nippers

- For piano wire, with knee-type joint to reduce cutting effort
- Enamelled finish

L mm	2000 N/mm <sup>2</sup> ø max mm	a mm	code
210	2,5	10	U01940004



### 196 N

#### Bolt cutters with central cutter

- Blades with high-resistance cutting edges
- Handgrips in PVC

L mm	2000 N/mm <sup>2</sup> ø max mm	1600 N/mm <sup>2</sup> ø max mm	Kg	code
450	6	7	1,9	U01960002
600	7	10	3,5	U01960003
750	9	13	4,5	U01960004
900	10	16	6,1	U01960005
1050	11	18	8,3	U01960006



### 196 NR

#### Bolt cutters with semi-flush cutter

- Blades with high-resistance cutting edges
- Handgrips in PVC

L mm	2000 N/mm <sup>2</sup> ø max mm	1600 N/mm <sup>2</sup> ø max mm	Kg	code
350	5	6	1,3	U01960001



### 196 AN

#### Spare blades

- For bolt cutters 196 N and 196 NR (size 350 mm)
- Blades supplied with bolts

L mm	code
R 350	U01960010Q
450	U01960020Q
600	U01960030Q
750	U01960040Q
900	U01960050Q
1050	U01960060Q



### 199

ISO 9242

#### Pincers for cement layers

- Carbon steel
- Phosphatized finish

L mm	a mm	code
190	15	U01990010
250	19	U01990013
225	17	U01990015
280	19	U01990150



### D 199

ISO 9242

#### Pincers for cement layers

L mm	a mm	code
190	15	U01990010D
225	17	U01990015D



### 200

#### Hacksaw

- Model for 300 mm blades with adjustable blade
- Screw for regulating blade tension
- Aluminium handle
- Supplied with steel blade

mm blade	L mm	code
300	12	U02000001



### 200 F

#### Aluminium hacksaw with Tension Control

- Model for 300 mm blades
- Adjustable blade with 8 different positions, every 45° rotation
- Constant tension of the blade built in the handle and calibrated at 110 kg for perfect cuts
- Constant cutting capacity (100 mm)
- Less vibrations
- Aluminium body with bimaterial handle
- Supplied with Cobalt blade 200 C24

mm blade	L mm	code
300	12	U02006003



### 200 L

#### Hacksaw

- Model for 300 mm blades
- Wooden handle
- Supplied with steel blade

mm blade	L mm	code
300	12	U02000003



### 200 S

#### Hacksaw

- Model for 300 mm blades with possibility of positioning the blade at 45° and 90°
- Blade tension regulator integrated in the handle
- Steel body with anti-slip and shock resistant plastic coating
- Supplied with Cobalt blade 200 C24

mm blade	L mm	code
300	12	U02000002



### 200 C/10 PCS

#### Spare blade for hacksaw (pack of 10 pcs.)

- HSS steel with high Cobalt content
- Excellent cut and long blade life

n° teeth	mm blade	L mm	code
18	300	12	U02000201
24	300	12	U02000202
32	300	12	U02000203



**201**

**Hacksaw**

- Light model for 150 mm blades
- Steel bow
- Supplied with Super Rapid steel blade (32 teeth per inch)

mm	blade	”	L mm	code	
150	6	237	U02010001	10	



**D 201**

**Hacksaw frame**

mm	blade	”	L mm	code	
150	6	237	U02010001D	1	



**201 S**

**Hacksaw with blade tensioner**

- Light model for 150 mm blades
- Supplied with Super Rapid steel blade (32 teeth per inch)

L mm	mm	blade	”	code	
255	150	6	U02010003	5	



**D 201 S**

**Hacksaw with blade tensioner**

L mm	mm	blade	”	code	
255	150	6	U02010003D	1	



**201 A**

**Spare blades**

- For hacksaw frames 201-201S

gr	code	
3	U02010101	10



**203 AN**

**Toggle joint shears for sheet steel**

- Model with straight blades
- Ergonomic bimaterial grip

L mm	a mm	400 N/mm <sup>2</sup> max mm	600 N/mm <sup>2</sup> max mm	code	
250	50	1,5	1	U02030001	1



**203 BN**

**Toggle joint shears for sheet steel**

- Model with right-cut blades
- Ergonomic bimaterial grip

L mm	a mm	400 N/mm <sup>2</sup> max mm	600 N/mm <sup>2</sup> max mm	code	
250	40	1,5	1	U02030002	1



**203 CN**

**Toggle joint shears for sheet steel**

- Model with left-cut blades
- Ergonomic bimaterial grip

L mm	a mm	400 N/mm <sup>2</sup> max mm	600 N/mm <sup>2</sup> max mm	code	
250	40	1,5	1	U02030003	1



**203 DN**

**Toggle joint shears for sheet steel**

- Model with left-cut blades for through cuts and shaping
- Ergonomic bimaterial grip

L mm	a mm	400 N/mm <sup>2</sup> max mm	600 N/mm <sup>2</sup> max mm	code	
260	40	1,8	1,2	U02030004	1



**203 EN**

**Toggle joint shears for sheet steel**

- Model with right-cut blades for through cuts and shaping
- Ergonomic bimaterial grip

L mm	a mm	400 N/mm <sup>2</sup> max mm	600 N/mm <sup>2</sup> max mm	code	
260	40	1,8	1,2	U02030005	1



**203 A**

**Spare springs**

n°	code	
1 for 203 AN-CN-DN	U02030006Q	5
2 for 203 BN-EN	U02030007Q	5

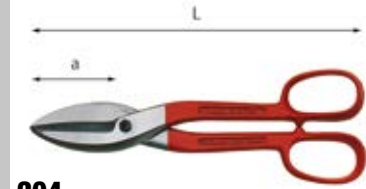

**204**

**Shears for sheet steel**

- American model with wide straight blades

L mm	a mm	400 N/mm <sup>2</sup> max mm	600 N/mm <sup>2</sup> max mm	code	
200	48	1	0,7	U02040002	1
250	58	1,2	0,8	U02040004	1
300	75	1,5	1	U02040006	1
350	95	1,5	1	U02040008	1



**D 204**

**Shears for sheet steel**

L mm	a mm	400 N/mm <sup>2</sup> max mm	600 N/mm <sup>2</sup> max mm	code	
200	48	1	0,7	U02040002D	1
250	58	1,2	0,8	U02040004D	1
300	75	1,5	1	U02040006D	1

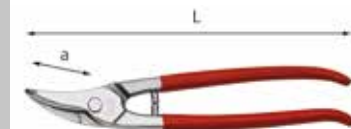

**206 A**

**Shears for sheet steel**

- Model with right-cut blades

L mm	a mm	400 N/mm <sup>2</sup> max mm	600 N/mm <sup>2</sup> max mm	code	
280	46	1,5	1	U02060101	1

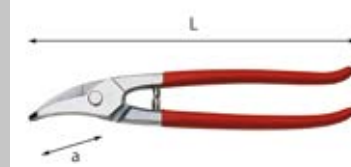

**206 B**

**Shears for sheet steel**

- Model with left-cut blades

L mm	a mm	400 N/mm <sup>2</sup> max mm	600 N/mm <sup>2</sup> max mm	code	
280	46	1,5	1	U02060102	1

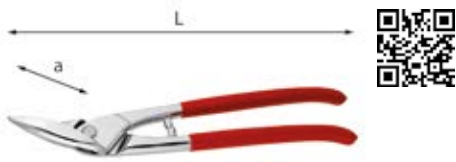

## 206 C

### Shears for sheet steel

- Model with left-cut blades

L mm	a mm	≤ 400 N/mm <sup>2</sup> max mm	≤ 600 N/mm <sup>2</sup> max mm	code	
280	50	1,5	1	U02060103	1

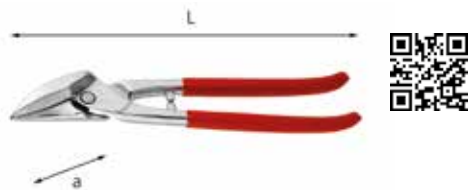

## 206 D

### Shears for sheet steel

- Model with right-cut blades

L mm	a mm	≤ 400 N/mm <sup>2</sup> max mm	≤ 600 N/mm <sup>2</sup> max mm	code	
280	50	1,5	1	U02060104	1

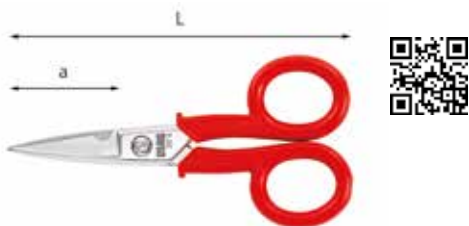

## 207 A

### Scissors for electricians

- Model with straight blades
- Handles sheathed in nylon
- Carbon steel body
- Nickel plated finish

L mm	a mm	h gr	code	
145	47	90	U02070101	5



## 207 C

### Scissors for electricians, steel blades

- Titanium covering steel blades with micro-toothing
- Bimaterial handles: flexural strength 60 Kg
- Built-in cable cutter capacity 12 mm (external diameter)
- Jaws for corrugated pipes

L mm	a mm	h gr	code	
143	45	80	U02070004	1



## 207 D

### Scissors for electricians, stainless steel blades

- Stainless steel blades with micro-toothing
- Glass-reinforced technopolymer handles: flexural strength 80 Kg
- Built-in cable cutter capacity 12 mm (external diameter)
- Supplied with plastic belt holder

L mm	a mm	h gr	code	
150	43	90	U02070008	1



## 207 E

### Professional scissors for electricians

- Stainless steel structure (blades and inside handles)
- Blade with micro antislip toothing
- Cable cutter on both blades (up to 50 mm<sup>2</sup>)
- Built-in wire stripper (1,5-2,5-4 mm<sup>2</sup>)
- Crimping function
- Bimaterial ergonomic shaped handles
- Hanging hole
- Supplied with plastic belt holder with safety block

L mm	a mm	h gr	code	
155	40	150	U02070006	1

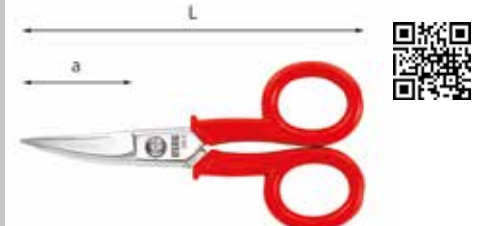

## 208 A

### Scissors for electricians

- Model with curved blades
- Handles sheathed in nylon
- Carbon steel body
- Nickel plated finish

L mm	a mm	h gr	code	
145	47	90	U02080101	5



## 207 E

### Scissors for electricians



YouTube



**Stainless steel structure, blades and inside handles**  
Resistance to flexion 180 Kg

**Cable cutter capacity:**  
Ø 15 mm

**Strippers and crimpers integrated into the handle**



### 209 Scissors for electricians

- Model with straight blades, one of which with micro tothing
- Handles sheathed in PVC
- Carbon steel body
- Nickel plated finish

L mm	a mm	g gr	code	img
150	33	120	U02090001	5



### 210 A Professional multi-purpose scissors

- Model with symmetrical handles
- Steel blades, Titanium coated
- Ergonomic bimaterial grip

L mm	g gr	code	img
175	70	U02100001	5



### 210 C Multi-purpose scissors

- Stainless steel blade with micro antislip tothing
- Big ergonomic bimaterial handleless
- Perfect for Aluminium, cardboard, rubber, leather, moquette, etc.

L mm	a mm	g gr	code	img
280	100	250	U02100003	1



### 211 A Multi-purpose scissors

- Blade with micro anti-slip tothing
- Selection lever to adapt to small and big hands
- Security lever to block the blades
- Antislip bimaterial ergonomic handgrips

L mm	a mm	g gr	code	img
210	60	200	U02110001	1

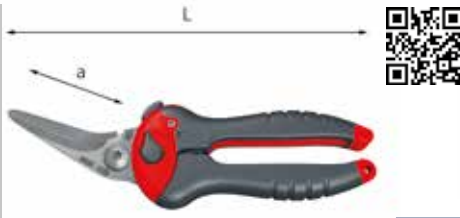

### 211 B Multi-purpose scissors with inclined blades

- Blade with micro anti-slip tothing
- Selection lever to adapt to small and big hands
- Security lever to block the blades
- Antislip bimaterial ergonomic handgrips

L mm	a mm	g gr	code	img
200	55	200	U02110002	1



### 215 B Panel punching and folding pliers

- Model with swivel head for piercing (Ø 5 mm) and folding (12 mm) the edges of sheet steel which must be welded

thickness max	L mm	code	img
0,8	290	U02150002	1

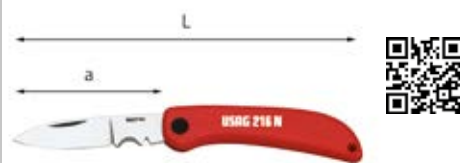

### 216 N Knife for electricians

- Clasp knife with wire stripper
- Plastic handle
- Stainless steel blade

L mm	a mm	code	img
200	85	U02160001	5



### 217 Knife for boat maintenance

- Clasp knife with an awl for loosening knots
- Plastic handle
- Stainless steel blade and awl

L mm	a mm	code	img
185	75	U02170001	1



### 218 N Utility knife

- Stainless steel blade
- Safety blade blocking
- Easy opening pin
- Aluminium body with polyamide inserts
- Hanging hole and glass-cutter
- Supplied in nylon pouch with closing clip and belt loop



L mm	a mm	code	img
190	72	U02180002	1



### 220 A1 Utility knife with snap-off blades

- Interchangeable 9 mm blade with snap-off sections
- Ergonomic ABS handle with soft covering
- Steel blade slide
- Automatic blade blocking
- Supplied with 2 spare blades

L mm	code	img
173	U02200000	6



### 220 AR Spare blades (100 pcs.)

- For utility knife 220 A1

L mm	g gr	code	img
80,6	240	U02200001Q	1



### 220 B1 Utility knife with snap-off blades

- Interchangeable 18 mm blade with snap-off sections
- Ergonomic ABS handle with soft covering
- Steel blade slide
- Automatic blade blocking
- Supplied with 2 spare blades

L mm	code	img
173	U02200001	6



## 220 B2

### Utility knife with snap-off blades

- Interchangeable 18 mm blade with snap-off sections and automatic loading of blades
- Ergonomic ABS handle with soft covering
- Steel blade slide
- Automatic blade blocking
- Blade blocking roll
- Supplied with 6 spare blades



L mm	code	
172	U02200002	6



## 220 BR

### Spare blades (100 pcs.)

- For utility knife 220 B2 and 220 B1

L mm	gr	code	
100	520	U02200002Q	1



## 220 C

### Utility knife with snap-off blades

- Interchangeable 22 mm blade (0,7 mm thick) with snap-off sections of steel with a high Carbon content
- Safety catch for extending and blocking the blade
- Automatic loading of blades
- Light alloy ergonomic handle
- Supplied with 3 spare blades stored in the handle

L mm	gr	code	
167	260	U02200003	2



## 220 CR

### Spare blades (50 pcs.)

- For utility knife 220 C

L mm	gr	code	
100	700	U02200003Q	1



## 221 AN

### Utility knife

- Interchangeable retractable 18 mm blade of steel with a high Carbon content
- Safety catch for extending and blocking the blade in three different positions
- Light alloy casing
- Enamelled finish
- Supplied with spare blade 221 AR/2, stored in the handle

L mm	gr	code	
160	177	U02210001	2



## 221 AR

### Spare blades

- For utility knife 221 AN
- Blade n.2 to be used with utility knife 221 B

n°	type	L mm	code	
1	Standard blade (100 pcs)	51,6	U02210001Q	1
2	Standard long blade (100 pcs)	60,7	U02210002Q	1
3	Double-hooked blade (50 pcs)	51,6	U02210003Q	1



## 221 B

### Safety knife with retractable blade

- Safety knife with retractable blade
- Automatic blade recall
- Light alloy ergonomic handle
- ABS catch with front and side thumb seat
- Supplied with 3 blades 221 AR/2 (1 fitted and 2 as replacement)

L mm	code	
173	U02210002	6

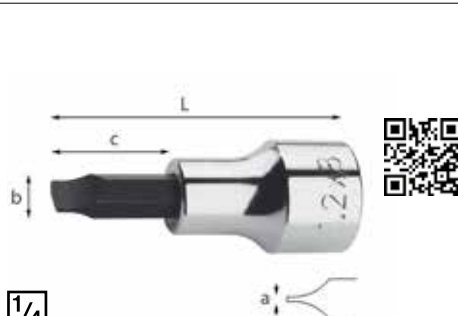

## 231 1/4" N

### ISO 2380-1 ISO 1174-1

### Socket bits for slot-head screws

- Special Chrome Vanadium steel
- Chrome plated finish with phosphatized insert

axbxc mm	L mm	code	
0,6x4x14	33	U02310009	5
1,2x6,5x14	33	U02310012	5
1,2x8x14	33	U02310014	5



## 231 3/8" N

### ISO 2380-1 ISO 1174-1

### Socket bits for slot-head screws

axbxc mm	L mm	code	
1x6,5x24	52	U02311012	5
1,2x8x24	52	U02311014	5

## 1/2

## 231 1/2" N

### ISO 2380-1 ISO 1174-1

### Socket bits for slot-head screws

axbxc mm	L mm	code	
1,2x8x24	60	U02312014	5
1,6x10x24	60	U02312016	5
2x12x24	60	U02312018	5

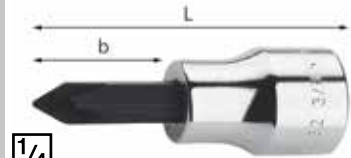

## 1/4

## 232 1/4" NPH

### ISO 8764-1 ISO 1174-1

### Socket bits for PHILLIPS® screws

- Special Chrome Vanadium steel
- Chrome plated finish with phosphatized insert

n°xb mm	L mm	code	
1x14	33	U02320011	5
2x14	33	U02320012	5
3x14	33	U02320013	5

## 3/8

## 232 3/8" NPH

### ISO 8764-1 ISO 1174-1

### Socket bits for PHILLIPS® screws

n°xb mm	L mm	code	
1x24	50	U02321011	5
2x24	50	U02321012	5
3x24	50	U02321013	5

## 1/2

## 232 1/2" NPH

### ISO 2380-1 ISO 1174-1

### Socket bits for PHILLIPS® screws

n°xb mm	L mm	code	
2x24	60	U02322012	5
3x24	60	U02322013	5
4x24	60	U02322014	5



## 1/4

## 233 1/4" NTX

### ISO 1174-1

### Socket bits for TORX® screws

- Special Chrome Vanadium steel
- Chrome plated finish with phosphatized insert

n°xb mm	L mm	code	
T8x14	33	U02330110	5
T9x14	33	U02330111	5
T10x14	33	U02330112	5
T15x14	33	U02330113	5
T20x14	33	U02330114	5
T25x14	33	U02330115	5
T27x14	33	U02330116	5
T30x14	33	U02330117	5
T40x14	33	U02330119	5

3/8



### 233 3/8" NTX

ISO 1174-1

#### Socket bits for TORX® screws

n°xb mm	L mm	code	
T10x24	51	U02331110	5
T15x24	51	U02331111	5
T20x24	51	U02331112	5
T25x24	51	U02331113	5
T27x24	51	U02331114	5
T30x24	51	U02331115	5
T40x24	51	U02331116	5
T45x24	51	U02331118	5
T50x24	51	U02331120	5

1/2



### 233 1/2" NTX

ISO 1174-1

#### Socket bits for TORX® screws

n°xb mm	L mm	code	
T20x24	60	U02332105	5
T25x24	60	U02332107	5
T27x24	60	U02332109	5
T30x24	60	U02332111	5
T40x24	60	U02332113	5
T40Lx84	120	U02332114	5
T45x24	60	U02332115	5
T45Lx84	120	U02332116	5
T50x24	60	U02332117	5
T55x24	60	U02332119	5
T55Lx104	140	U02332120	5
T60x24	60	U02332121	5
T70Lx104	140	U02332124	5



3/8

### 233 3/8" NTX/S7

#### Set of 7 socket bits for TORX® screws

- Supplied with plastic stands 559 3/8" and metal holder 559 B/250

pcs description	item/size
7 Socket bits for TORX® screws / T15-T20-T25-T27-T30-T40-T45	233 3/8 NTX

à gr	code	
400	U02331551	1



1/2

### 233 1/2" NTX/S9

#### Set of 9 socket bits for TORX® screws

- Supplied with plastic stands 559 1/2" and metal holder 559 B/250

pcs description	item/size
9 Socket bits for TORX® screws / T20-T25-T27-T30-T40-T45-T50-T55-T60	233 1/2 NTX

à gr	code	
800	U02332551	1



### 233 1/2" NTX/C9

#### Assortment with socket bits for TORX® screws in ABS case (9 pcs.)

- High resistance ABS case with quick closing system
- The inside tray is studied to be stored in USAG roller cabinet drawers
- Empty inner plastic tray: code U05190701Q

pcs description	item/size
9 Socket bits for TORX® screws/ T20-T25-T27-T30-T40-T45-T50-T55-T60	233 1/2 NTX
1 Empty ABS case - size S	606 S

LxPxH mm	à gr	code	
210x130x60	680	U02332556	1



1/2

### 233 1/2" MNTX

ISO 1174-2

#### Long impact socket bits for TORX® screws

- Special Chrome Molybdenum steel
- Phosphatized finish
- Employ safety pin 235 MCA/4 (U02350204Q) for the sizes from T30 to T60
- Employ locking ring 235 MDA/4 (U02350224Q) for the sizes from T30 to T60

n°xb mm	L mm	code	
by FACOM T20x55	78	U02330620	1
by FACOM T25x55	78	U02330625	1
T30x55	78	U02330610	1
T40x55	78	U02330611	1
T45x55	78	U02330612	1
T50x55	78	U02330613	1
T55x55	78	U02330614	1
T60x55	78	U02330615	1
by FACOM T70x55	78	U02330670	1



1/2

### 233 1/2" MNTX/C6

#### Assortment with long IMPACT socket bits for TORX® screws in ABS case (6 pcs.)

- High resistance ABS case with quick closing system
- The inside tray is studied to be stored in USAG roller cabinet drawers
- Empty inner foam module: code U05191024Q

pcs description	item/size
6 Long impact socket bits for TORX® screws/ T30-T40-T45-T50-T55-T60	233 1/2 MNTX
1 Empty ABS case - size S	606 S

LxPxH mm	code	
210x130x60	U02332514	1

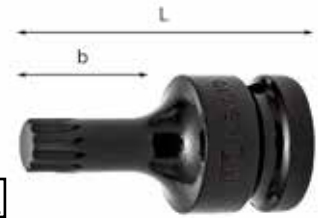

1/2

### 233 1/2" MXZNC

by FACOM

#### Impact socket bits for XZN screws

- Special Chrome Molybdenum steel
- Phosphatized finish
- Employ safety pin 235 MCA/4 (U02350204Q) for the sizes 6÷18
- Employ locking ring 235 MDA/4 (U02350224Q) for the sizes 6÷18

n°xb mm	L mm	code	
6x29	50	U02330706	1
8x29	50	U02330708	1
10x29	50	U02330710	1
12x29	50	U02330712	1
14x29	50	U02330714	1
16x29	50	U02330716	1
18x29	50	U02330718	1

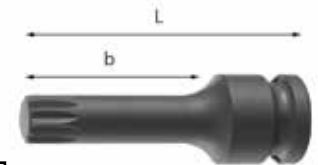

1/2

### 233 1/2" MXZN

ISO 1174-1

#### XZN impact socket wrench for rear wheel-hub - AUDI/VW/SEAT/SKODA

- To assemble/disassemble the screw on the rear wheel-hub
- Special Nickel Chrome Molybenum steel
- Phosphatized finish

n°xb mm	L mm	code	
18x54,5	78	U02332182	1



1/2

### 233 1/2" NXZN

ISO 1174-1

#### Socket bits for XZN screws

- Sizes 9-9L ideal for cylinder heads of Toyota, Honda, Kia
- Special Chrome Molybdenum steel
- Chrome plated finish with burnished insert

n°xb mm	L mm	code	
5x24	60	U02332152	1
6x24	60	U02332153	1
6Lx64	100	U02332154	1
8x24	60	U02332156	1
8Lx64	100	U02332157	1
9x24	60	U02332171	1
9Lx64	100	U02332172	1
10x24	60	U02332159	1
10Lx64	100	U02332160	1
10L1x84	120	U02332161	1
12x24	60	U02332163	1
12Lx64	100	U02332164	1
12L1x104	140	U02332165	1
14x24	60	U02332167	1
14Lx64	100	U02332168	1
16x24	60	U02332170	1





**1/2**  
**233 1/2" NXZN/S7**

**Set of 7 socket bits for XZN screws**

- Supplied with plastic stands 559 1/2" and metal holder 559 B/250

pcs	description	item/size
7	Socket bits for XZN screws / 5-6-8L-10L-12L-14-16	233 1/2 NXZN

à gr	code	
700	U02332509	1



**1/2**  
**233 1/2" NXZN/S8**

**Set of 8 socket bits for XZN screws**

- Supplied with plastic stands 559 1/2" and metal holder 559 B/250

pcs	description	item/size
8	Socket bits for XZN screws / 6-6L-8-8L-10-10L-12-12L	233 1/2 NXZN

à gr	code	
840	U02332510	1



**1/2**  
**233 1/2" NXZN/C6**

**Assortment with socket bits for XZN screws in ABS case (6 pcs.)**

- High resistance ABS case with quick closing system  
- The inside tray is studied to be stored in USAG roller cabinet drawers  
- Empty inner plastic tray: code U05190702Q

pcs	description	item/size
6	Socket bits for XZN screws / 6L-8L-10L-10L1-12L-12L1	233 1/2 NXZN
1	Empty ABS case - size S	606 S

LxPxH mm	à gr	code	
210x130x60	750	U02332512	1



**1/2**  
**233 1/2" NXZN/C8**

**Assortment with socket bits for XZN screws in ABS case (8 pcs.)**

- High resistance ABS case with quick closing system  
- The inside tray is studied to be stored in USAG roller cabinet drawers  
- Empty inner plastic tray: code U05190703Q

pcs	description	item/size
8	Socket bits for XZN screws / 6-6L-8-8L-10-10L-12-12L	233 1/2 NXZN
1	Empty ABS case - size S	606 S

LxPxH mm	à gr	code	
210x130x60	800	U02332511	1



**1/2**  
**233 1/2" NS**

**Socket bits for splined hexagonal screws (RIBE)**

- Special Chrome Molybdenum steel  
- Chrome plated finish with burnished insert

n°	b mm	L mm	code	
7	24	60	U02332005	1
7L	64	100	U02332006	1
9L	64	100	U02332012	1
10	24	60	U02332014	1
10L	64	100	U02332015	1
12L	64	100	U02332018	1
14L	64	100	U02332021	1
16L	64	100	U02332024	1



**1/4**  
**234 1/4" N**

**Socket bits for hex socket screws**

- Special Chrome Vanadium steel  
- Chrome plated finish with phosphatized insert

n°xb mm	L mm	code	
2,5x14	33	U02340004	5
3x14	33	U02340008	5
4x14	33	U02340016	5
5x14	33	U02340024	5
6x14	33	U02340028	5
7x14	33	U02340032	5
8x14	33	U02340036	5

**3/8**  
**234 3/8" N**

**Socket bits for hex socket screws**

n°xb mm	L mm	code	
2,5x24	51	U02341004	5
3x24	51	U02341008	5
4x24	51	U02341016	5
5x24	51	U02341024	5
6x24	51	U02341028	5
7x24	51	U02341032	5
8x24	51	U02341036	5
10x24	51	U02341040	5

**1/2**  
**234 1/2" N**

**Socket bits for hex socket screws**

n°xb mm	L mm	code	
5x24	60	U02342004	5
5L2x144	180	U02342007	1
6x24	60	U02342008	5
6Lx64	100	U02342009	1
6L1x104	140	U02342010	1
6L2x184	220	U02342011	1
7x24	60	U02342012	5
7Lx64	100	U02342013	1
8x24	60	U02342016	5
8Lx64	100	U02342017	1
10x24	60	U02342022	5
10Lx104	140	U02342023	1
12x24	60	U02342027	5
12Lx64	100	U02342029	1
14x24	60	U02342033	5
17x24	60	U02342040	5
19x24	60	U02342048	5



**3/8**  
**234 3/8" N/S8**

**Set of 8 socket bits for hex socket screws**

- Supplied with plastic stands 559 3/8" and metal holder 559 B/250

pcs	description	item/size
8	Socket bits for hex socket screws / 2,5-3-4-5-6-7-8-10	234 3/8 N

à gr	code	
500	U02341510	1

**1/2**  
**234 1/2" N/S8**

**Set of 8 socket bits for hex socket screws**

- Supplied with plastic stands 559 1/2" and metal holder 559 B/250

pcs	description	item/size
8	Socket bits for hex socket screws / 5-6-7-8-10-12-14-17	234 1/2 N

à gr	code	
900	U02342510	1



1/2

### 234 1/2" N/C9

#### Assortment with socket bits for hex socket screws in ABS case (9 pcs.)

- High resistance ABS case with quick closing system
- The inside tray is studied to be stored in USAG roller cabinet drawers
- Empty inner plastic tray: code U05190701Q

pcs	description	item/size
9	Socket bits for hex socket screws / 5-6-7-8-10-12-14-17-19	234 1/2 N
1	Empty ABS case - size S	606 S

LxPxH mm	kg	code	
210x130x60	1	U02342512	1



1/2

### 234 1/2" N/S8L

#### Set of 8 long socket bits for hex socket screws

- Supplied with plastic stands 559 1/2" and metal holder 559 B/250

pcs	description	item/size
8	Socket bits for hex socket screws / 5L2-6L-6L1-6L2-7L-8L-10L-12L	234 1/2 N

kg	code	
1,2	U02342511	1



1/2

### 234 1/2" MN

ISO 1174-2

#### Impact socket bits for hex socket screws

- Special Chrome Molybdenum steel
- Phosphatized finish
- Employ safety pin 235 MCA/4 (U02350204Q) for the sizes from 8 to 19
- Employ locking ring 235 MDA/4 (U02350224Q) for the sizes from 8 to 19

n°xb mm	L mm	code	
8x55	78	U02340713	1
10x55	78	U02340714	1
12x55	78	U02340715	1
14x55	78	U02340716	1
17x55	78	U02340717	1
19x55	78	U02340718	1



1/2

### 234 1/2" MN/C8

#### Assortment with impact socket bits for hex socket screws in ABS case (8 pcs.)

- High resistance ABS case with quick closing system
- The inside tray is studied to be stored in USAG roller cabinet drawers
- Empty inner foam module: code U05191025Q

pcs	description	item/size
8	Impact socket bits for hex socket screws / 5-6-8-10-12-14-17-19	234 1/2 MN
1	Empty ABS case - size M	606 M

LxPxH mm	code	
330x215x60	U02342513	1



3/4

### 234 3/4" N

ISO 2936 ISO 1174-1

#### Socket bits for hex socket screws

- Special Chrome Vanadium steel
- Chrome plated finish

n°xb mm	L mm	code	
14x15	74	U02343003	1
17x18	74	U02343010	1
19x23	74	U02343018	1
22x23	74	U02343025	1



1/4

### 235 1/4" EN

ISO 2725-2

#### Hexagonal sockets

- Special Chrome Molybdenum steel
- Chrome plated finish

O mm	b mm	L mm	code	
4	6,9	22	U02350103	5
4,5	7,5	22	U02350104	5
5	8,2	22	U02350105	5
5,5	8,8	22	U02350106	5
6	9,4	22	U02350107	5
7	10,9	22	U02350108	5
8	11,9	22	U02350109	5
9	13,1	22	U02350110	5
10	14,6	22	U02350111	5
11	15,7	22	U02350112	5
12	16,9	22	U02350113	5
13	17,6	22	U02350114	5
14	18,6	22	U02350115	5

1/4

### 235 1/4" EPN

ISO 1174-1

#### Hexagonal sockets, inch sizes

- Special Chrome Molybdenum steel
- Chrome plated finish

O "	b mm	L mm	code	
1/8	5,9	22	U02350151	2
5/32	6,9	22	U02350152	2
3/16	8	22	U02350153	2
7/32	9	22	U02350154	2
1/4	10,1	22	U02350155	2
9/32	10,9	22	U02350156	2
5/16	11,9	22	U02350157	2
11/32	13,1	22	U02350158	2
3/8	14,6	22	U02350159	2
7/16	15,7	22	U02350161	2
1/2	17,6	22	U02350162	2
9/16	18,6	22	U02350164	2

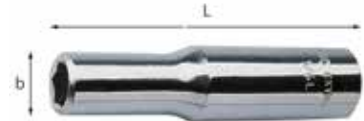

1/4

### 235 1/4" EL

ISO 2725-1

#### Long hexagonal sockets

- Special Chrome Molybdenum steel
- Chrome plated finish

O mm	b mm	L mm	code	
4	6,5	50	U02350532	2
4,5	7	50	U02350533	2
5	7,5	50	U02350534	2
5,5	8,5	50	U02350535	2
6	9,5	50	U02350536	2
7	10,5	50	U02350537	2
8	12	50	U02350538	2
9	13	50	U02350539	2
10	14	50	U02350540	2
11	16	50	U02350541	2
12	17	50	U02350542	2
13	17,5	50	U02350543	2
14	20	50	U02350544	2



1/4

### 235 1/4" EL/C10

#### Assortment with long hexagonal sockets in ABS case (10 pcs.)

- High resistance ABS case with quick closing system
- The inside tray is studied to be stored in USAG roller cabinet drawers
- Empty inner plastic tray: code U05190705Q

pcs	description	item/size
10	Long hexagonal sockets / 5,5-6-7-8-9-10-11-12-13-14	235 1/4 EL
1	Empty ABS case - size S	606 S

LxPxH mm	kg	code	
210x130x60	670	U02359221	1



**1/4**  
**235 1/4" ERN**

by **FACOM**

**Short hexagonal sockets**

- Ideal to work in narrow spaces
- 50% less bulky than 1/4" standard sockets
- Can be used with ratchet 237 1/4"FK or with an 11 mm bihexagonal wrench
- Satin Chrome finish

O mm	b mm	L mm	code	
5,5	8,2	18	U02350707	1
6	9,2	18	U02350708	1
7	10,4	18	U02350709	1
8	11,5	18	U02350710	1
9	12,4	18	U02350711	1
10	13,8	18	U02350712	1
11	15,8	18	U02350713	1
12	16,8	18	U02350714	1
13	17,8	18	U02350715	1
14	19,8	18	U02350716	1



**3/8**  
**235 3/8" LN**

ISO 2725-1

**Bihexagonal sockets**

- Special Chrome Molybdenum steel
- Chrome plated finish

O mm	b mm	L mm	code	
6	9,2	27	U02350001	5
7	10,5	27	U02350002	5
8	11,8	27	U02350003	5
9	13	27	U02350004	5
10	14,4	27	U02350005	5
11	15,6	27	U02350006	5
12	16,5	27	U02350007	5
13	18,4	30	U02350008	5
14	19,4	30	U02350009	5
15	20,7	30	U02350010	5
16	21,9	30	U02350011	5
17	23,3	30	U02350012	5
18	24,6	33	U02350013	5
19	25,9	33	U02350014	5
20	28,4	33	U02350118	5
21	29,6	33	U02350119	5
22	27,1	33	U02350015	5



**3/8**  
**235 3/8" P**

ISO 1174-1

**Bihexagonal sockets, inch sizes**

- Special Chrome Molybdenum steel
- Chrome plated finish

O	b mm	L mm	code	
1/4	10,5	27	U02350016	2
5/16	11,8	27	U02350017	2
3/8	14,4	27	U02350019	2
7/16	15,6	27	U02350020	2
1/2	18	30	U02350021	2
9/16	19,4	30	U02350022	2
5/8	21,9	30	U02350024	2
11/16	23,9	33	U02350025	2
3/4	25,9	33	U02350026	2
13/16	27,9	33	U02350027	2
7/8	29,6	33	U02350028	2



**3/8**  
**235 3/8" E**

ISO 2725-1

**Hexagonal sockets**

- Special Chrome Molybdenum steel
- Chrome plated finish

O mm	b mm	L mm	code	
6	9,2	27	U02350130	5
7	10,5	27	U02350131	5
8	11,8	27	U02350132	5
9	13	27	U02350133	5
10	14,4	27	U02350134	5
11	15,6	27	U02350135	5
12	16,5	27	U02350136	5
13	18,4	30	U02350137	5
14	19,4	30	U02350138	5
15	20,7	30	U02350139	5
16	21,9	30	U02350140	5
17	23,3	30	U02350141	5
18	24,6	33	U02350142	5
19	25,9	33	U02350143	5
20	27,1	33	U02350144	5
21	28,4	33	U02350145	5
22	29,6	33	U02350146	5



**3/8**  
**235 3/8" S17**

**Set of 17 bihexagonal sockets**

- Supplied with plastic stands 559 3/8" and metal holders 559 B/250

pcs	description	item/size
17	Bihexagonal sockets / 6-7-8-9-10-11-12-13-14-15-16-17-18-19-20-21-22	235 3/8

à gr	code	
900	U02350086	1



**3/8**  
**235 3/8" E/S17**

**Set of 17 hexagonal sockets**

- Supplied with plastic stands 559 3/8" and metal holders 559 B/250

pcs	description	item/size
17	Hexagonal sockets / 6-7-8-9-10-11-12-13-14-15-16-17-18-19-20-21-22	235 3/8 E

à gr	code	
900	U02350194	1

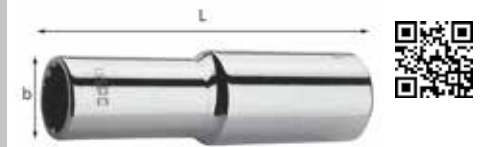

**3/8**  
**235 3/8" LN**

ISO 2725-1

**Long bihexagonal sockets**

- Special Chrome Molybdenum steel
- Chrome plated finish

O mm	b mm	L mm	code	
8	12	53	U02351206	2
9	13,1	53	U02351207	2
10	14,7	53	U02351208	2
11	16	53	U02351209	2
12	16,8	53	U02351210	2
13	18	53	U02351211	2
14	19,5	53	U02351212	2
15	20,4	53	U02351213	2
16	22	60	U02351214	2
17	23,3	60	U02351215	2
18	24,2	60	U02351216	2
19	25,5	60	U02351217	2
20	26,8	60	U02351218	2
21	27,7	60	U02351219	2
22	29,5	60	U02351220	2



**3/8**  
**235 3/8" ELN**

ISO 2725-1

**Long hexagonal sockets**

- Special Chrome Molybdenum steel
- Chrome plated finish

O mm	b mm	L mm	code	
8	12	53	U02351306	2
9	13,1	53	U02351307	2
10	14,7	53	U02351308	2
11	16	53	U02351309	2
12	16,8	53	U02351310	2
13	18	53	U02351311	2
14	19,5	53	U02351312	2
15	20,4	53	U02351313	2
16	22	60	U02351314	2
17	23,3	60	U02351315	2
18	24,2	60	U02351316	2
19	25,5	60	U02351317	2
20	26,8	60	U02351318	2
21	27,7	60	U02351319	2
22	29,5	60	U02351320	2

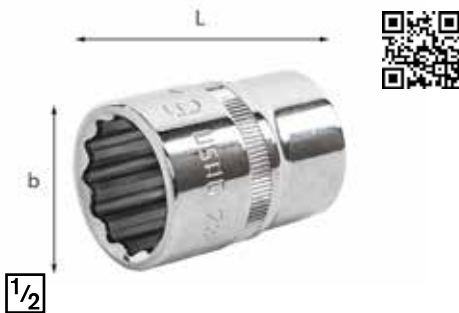

1/2

## 235 1/2" N

ISO 2725-1

### Bihexagonal sockets

- Special Chrome Molybdenum steel
- Chrome plated finish

O mm	b mm	L mm	code	
8	13,1	36	U02352003	5
9	13,8	36	U02352004	5
10	15,3	36	U02352005	5
11	16,5	36	U02352006	5
12	17,8	36	U02352007	5
13	18,9	36	U02352008	5
14	20,2	36	U02352009	5
15	21,4	36	U02352010	5
16	22,6	36	U02352011	5
17	24,1	36	U02352012	5
18	25,4	36	U02352013	5
19	26,6	36	U02352014	5
20	27,4	36	U02352015	5
21	29,1	38	U02352016	5
22	30,4	38	U02352017	5
23	31,6	38	U02352018	5
24	32,7	38	U02352019	5
25	34,1	38	U02352020	5
26	35,4	38	U02352021	5
27	36,6	44	U02352022	5
28	37,9	44	U02352023	5
29	38,7	44	U02352024	5
30	40,4	44	U02352025	5
32	42,5	44	U02352027	5



1/2

## 235 1/2" N/SE15

### Set of 15 bihexagonal sockets

pcs	description	item/size
15	Bihexagonal sockets / 8-9-10-11-12-13-14-15-16-17-18-19-20-21-22	235 1/2 N

à Kg	code	
1	U02359215	1



1/2

## 235 1/2" N/SE23

### Set of 23 bihexagonal sockets

pcs	description	item/size
23	Bihexagonal sockets / 8-9-10-11-12-13-14-15-16-17-18-19-20-21-22-23-24-25-26-27-28-30-32	235 1/2 N

à Kg	code	
2,2	U02359217	1



1/2

## 235 1/2" N/G22

### Assortment with bihexagonal sockets in ABS case (22 pcs.)

- High resistance ABS case with quick closing system
- The inside tray is studied to be stored in USAG roller cabinet drawers
- Empty inner plastic tray: code U05190706Q

pcs	description	item/size
22	Bihexagonal sockets /8-9-10-11-12-13-14-15-16-17-18-19-21-22-23-24-26-27-28-29-30-32	235 1/2 N
1	Empty ABS case - size M	606 M

LxPxH mm	à Kg	code	
330x215x60	2,8	U02359223	1



1/2

## 235 1/2" EN/G22

### Assortment with hexagonal sockets in ABS case (22 pcs.)

- High resistance ABS case with quick closing system
- The inside tray is studied to be stored in USAG roller cabinet drawers
- Empty inner plastic tray: code U05190706Q

pcs	description	item/size
22	Hexagonal sockets /8-9-10-11-12-13-14-15-16-17-18-19-21-22-23-24-26-27-28-29-30-32	235 1/2 EN
1	Empty ABS case - size M	606 M

LxPxH mm	à Kg	code	
330x215x60	2,8	U02359222	1

1/2

## 235 1/2" PN

### Bihexagonal sockets, inch sizes

- Special Chrome Molybdenum steel
- Chrome plated finish

O"	b mm	L mm	code	
3/8	14,7	36	U02352053	2
7/16	16,5	36	U02352054	2
1/2	18,9	36	U02352055	2
9/16	20,2	36	U02352057	2
5/8	22,6	36	U02352059	2
11/16	24,6	36	U02352061	2
3/4	27	36	U02352062	2
13/16	28,6	38	U02352064	2
7/8	30,4	38	U02352065	2
15/16	32,7	38	U02352067	2
1	34,7	38	U02352068	2

## 235 1/2" PN

O"	b mm	L mm	code	
1 1/16	36,6	44	U02352069	2
1 1/8	38,7	44	U02352070	2
1 3/16	40,4	44	U02352071	2
1 1/4	42,5	44	U02352072	2



1/2

## 235 1/2" EN

ISO 2725-1

### Hexagonal sockets

- Special Chrome Molybdenum steel
- Chrome plated finish

O mm	b mm	L mm	code	
8	13,1	36	U02352103	5
9	13,8	36	U02352104	5
10	15,3	36	U02352105	5
11	16,5	36	U02352106	5
12	17,8	36	U02352107	5
13	18,9	36	U02352108	5
14	20,2	36	U02352109	5
15	21,4	36	U02352110	5
16	22,6	36	U02352111	5
17	24,1	36	U02352112	5
18	25,4	36	U02352113	5
19	26,6	36	U02352114	5
20	27,4	36	U02352115	5
21	29,1	38	U02352116	5
22	30,4	38	U02352117	5
23	31,6	38	U02352118	5
24	32,7	38	U02352119	5
25	34,1	38	U02352120	5
26	35,4	38	U02352121	5
27	36,6	44	U02352122	5
28	37,9	44	U02352123	5
29	38,7	44	U02352124	5
30	40,4	44	U02352125	5
32	42,5	44	U02352127	5



1/2

## D 235 1/2" EN

ISO 2725-1

### Hexagonal sockets

O mm	b mm	L mm	code	
8	13,1	36	U02352103D	1
9	13,8	36	U02352104D	1
10	15,3	36	U02352105D	1
11	16,5	36	U02352106D	1
12	17,8	36	U02352107D	1
13	18,9	36	U02352108D	1
14	20,2	36	U02352109D	1
15	21,4	36	U02352110D	1
16	22,6	36	U02352111D	1
17	24,1	36	U02352112D	1
18	25,4	36	U02352113D	1
19	26,6	36	U02352114D	1
20	27,4	36	U02352115D	1
21	29,1	38	U02352116D	1
22	30,4	38	U02352117D	1
23	31,6	38	U02352118D	1
24	32,7	38	U02352119D	1
25	34,1	38	U02352120D	1

## D 235 1/2" EN

Ø mm	b mm	L mm	code	
26	35,4	38	U02352121D	5
27	36,6	44	U02352122D	5
28	37,9	44	U02352123D	5
29	38,7	44	U02352124D	5
30	40,4	44	U02352125D	5
32	42,5	44	U02352127D	5



## 235 1/2" EN/SE15

### Set of 15 hexagonal sockets

pcs description	item/size
15 Hexagonal sockets / 8-9-10-11-12-13-14-15-16-17-18-19-20-21-22	235 1/2 EN

kg	code	
1	U02359205	1



## 235 1/2" EN/SE23

### Set of 23 hexagonal sockets

pcs description	item/size
23 Hexagonal sockets / 8-9-10-11-12-13-14-15-16-17-18-19-20-21-22-23-24-25-26-27-28-30-32	235 1/2 EN

kg	code	
2,2	U02359207	1



## 235 1/2" N/S15

### Set of 15 bihexagonal sockets

- Supplied with plastic stands 559 1/2" and metal holders 559 B/250

pcs description	item/size
15 Bihexagonal sockets / 10-11-12-13-14-15-16-17-19-20-22-24-27-30-32	235 1/2 N

kg	code	
1,7	U02359225	1



## 235 1/2" EN/S15

### Set of 15 hexagonal sockets

- Supplied with plastic stands 559 1/2" and metal holders 559 B/250

pcs description	item/size
15 Hexagonal sockets / 10-11-12-13-14-15-16-17-19-20-22-24-27-30-32	235 1/2 EN

kg	code	
1,6	U02359220	1



## 235 1/2" LN

### Long bihexagonal sockets

- Special Chrome Molybdenum steel  
- Chrome plated finish

Ø mm	b mm	L mm	code	
10	15,5	79	U02352205	5
11	16,7	79	U02352206	5
12	18	79	U02352207	5
13	19,2	79	U02352208	5
14	20,5	79	U02352209	5
15	21	79	U02352210	5
16	22,5	79	U02352211	5
17	24	79	U02352212	5
18	25,3	79	U02352213	5
19	26,5	79	U02352214	5
21	27,8	79	U02352216	5
22	29,8	79	U02352217	5
24	31,8	79	U02352219	5
27	35,8	79	U02352222	5
30	39,8	79	U02352225	5
32	41,3	79	U02352227	5



## 235 1/2" LN/C10

### Assortment with long bihexagonal sockets in ABS box (10 pcs.)

- High resistance ABS case with quick closing system  
- The inside tray is studied to be stored in USAG roller cabinet drawers  
- Empty inner plastic tray: code U05190829Q

pcs description	item/size
10 Long bihexagonal sockets / 10-12-13-14-15-16-17-19-21-22	235 1/2 LN
1 Empty ABS case - size L	606 L

LxPxH mm	kg	code	
435x270x70	1,6	U02359274	1



## 235 3/4" N

ISO 2725-1

### Bihexagonal sockets

- Special Chrome Vanadium steel  
- Chrome plated finish

Ø mm	b mm	L mm	code	
19	30,2	49	U02353004	4
21	31,9	49	U02353006	4
22	33,4	51	U02353007	4
23	36	53	U02353008	4
24	36	53	U02353009	4
26	39	53	U02353011	4
27	39,8	52,5	U02353012	4
28	41	53	U02353013	4
30	43	59	U02353015	4
32	46	59	U02353017	4
33	48	59	U02353018	2
34	48,5	59	U02353019	2
36	51	59	U02353021	2
38	54,3	67	U02353023	2
41	57,3	67	U02353025	2
46	63,5	75	U02353027	2
50	68,5	75	U02353029	2
55	74,8	75	U02353031	2



## 235 3/4" PN

### Bihexagonal sockets, inch sizes

- Special Chrome Vanadium steel  
- Chrome plated finish

Ø"	b mm	L mm	code	
7/8	33,7	51	U02353054	1
15/16	36	51	U02353056	1
1	38	52,5	U02353057	1
1 1/16	39,8	52,5	U02353058	1
1 1/8	41,7	52,5	U02353059	1
1 1/4	46	59	U02353061	1
1 5/16	48,2	59	U02353063	1
1 3/8	50,2	59	U02353065	1
1 7/16	51	59	U02353066	1
1 1/2	54,3	67	U02353067	1
1 5/8	57,3	67	U02353071	1
1 11/16	60,7	67	U02353073	1
1 3/4	62,2	67	U02353074	1
1 13/16	63,5	75	U02353076	1
1 7/8	66,2	75	U02353077	1
2	68,5	75	U02353080	1



3/4

**235 3/4" EN**

ISO 2725-1

**Hexagonal sockets**

- Special Chrome Vanadium steel
- Chrome plated finish

Ø mm	b mm	L mm	code	
19	30,2	49	U02353104	4
21	31,9	49	U02353106	1
22	33,4	51	U02353107	4
23	36	53	U02353108	4
24	36	53	U02353109	4
26	39	52,5	U02353111	4
27	39,8	53	U02353112	4
28	41	53	U02353113	4
29	42	52,5	U02353114	1
30	43	59	U02353115	4
32	46	59	U02353117	4
33	48	59	U02353118	2
34	48,5	59	U02353119	2
35	49,9	59	U02353120	1
36	51	59	U02353121	2
38	54,3	67	U02353123	2
40	55,9	66,9	U02353124	1
41	57,3	67	U02353125	2
42	59,4	66,9	U02353126	1
43	59,4	66,9	U02353134	1
44	61,9	66,9	U02353135	1
46	63,5	75	U02353127	2
50	68,5	75	U02353129	2
54	73,9	75	U02353130	1
55	74,8	75	U02353131	2

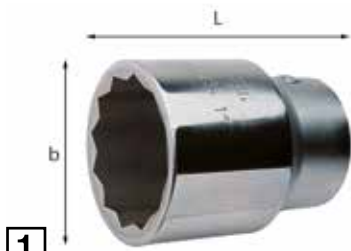

1

**235 1" N**

ISO 2725-1

**Bihexagonal sockets (for Iveco)**

- Special Chrome Vanadium steel
- Chrome plated finish
- For IVECO wheel hubs

Ø mm	b mm	L mm	code	
65	89	92	U02354014	1

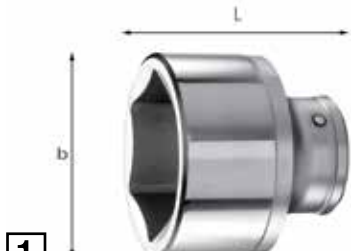

1

**235 1" EN**

ISO 2725-1

**Hexagonal sockets**

- Special Chrome Vanadium steel
- Chrome plated finish

Ø mm	b mm	L mm	code	
41	57,5	74	U02354106	1

**235 1" EN**

Ø mm	b mm	L mm	code	
46	65	76	U02354108	1
50	70	80	U02354110	1
55	76	84	U02354112	1
60	83	87	U02354113	1
65	89	92	U02354114	1
70	95	96	U02354115	1
75	101	100	U02354116	1
80	108	106	U02354117	1

1

**235 1" EPN**

ISO 691 ISO 1174-1

**Hexagonal sockets, inch sizes**

- Special Chrome Vanadium steel
- Chrome plated finish

Ø"	b mm	L mm	code	
1 7/8	67	80	U02354163	1
2	70	80	U02354166	1
2 3/16	75,5	84	U02354169	1
2 1/4	79	84	U02354170	1
2 3/8	82,5	87	U02354172	1
2 1/2	86	92	U02354174	1
2 5/8	90,5	92	U02354177	1
2 3/4	94	96	U02354180	1
3	104	100	U02354182	1
3 1/8	108	106	U02354184	1



1/4

**235 1/4" TX**

ISO 1174-1

**TORX® sockets**

- Special Chrome Molybdenum steel
- Chrome plated finish

n°	b mm	L mm	code	
E4	5,5	25	U02350402	2
E5	7	25	U02350403	2
E6	8	25	U02350404	2
E7	9	25	U02350405	2
E8	9,8	25	U02350406	2
E10	12	25	U02350408	2

3/8

**235 3/8" NTX**

ISO 1174-1

**TORX® sockets**

- Special Chrome Molybdenum steel
- Chrome plated finish

n°	b mm	L mm	code	
E4	5,5	32	U02351402	2
E5	7	32	U02351403	2
E6	8	32	U02351404	2
E7	9	32	U02351405	2
E8	10,5	32	U02351406	2
E10	14	32	U02351408	2
E12	16	32	U02351409	2
E14	18	32	U02351410	2
E16	20	32	U02351412	2



1/2

**235 1/2" NTX**

ISO 1174-1

**TORX® sockets**

- Special Chrome Molybdenum steel
- Chrome plated finish

n°	b mm	L mm	code	
E10	14	38	U02352405	2
E12	16	38	U02352406	2
E14	18	38	U02352407	2
E16	20	38	U02352409	2
E18	22	38	U02352410	2
E20	24	38	U02352411	2
E24	28	38	U02352412	2

3/8

**235 3/8" NTX/S8**

**Set of 8 TORX® sockets**

- Supplied with plastic stands 559 3/8" and metal holder 559 B/250

pcs description	item/size
8 TORX® sockets / E5-E6-E7-E8-E10-E12-E14-E16	235 3/8 NTX

à gr	code	
300	U02359185	1



1/2

**235 1/2" NTX/S7**

**Set of 7 TORX® sockets**

- Supplied with plastic stands 559 1/2" and metal holder 559 B/250

pcs description	item/size
7 TORX® sockets / E10-E12-E14-E16-E18-E20-E24	235 1/2 NTX

à gr	code	
700	U02359260	1

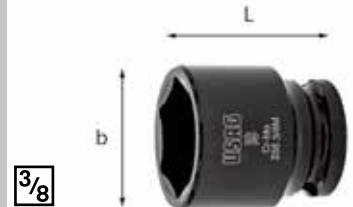

3/8

**235 3/8" M**

ISO 2725-2

**Impact hexagonal sockets**

- Special Chrome Molybdenum steel
- Phosphatized finish
- Employ safety pin 235 MCA/1 (U02350201Q) for the sizes from 6 to 12 and 235 MCA/2 (U02350202Q) for the sizes from 13 to 19
- Employ locking ring 235 MDA/1 (U02350221Q) for the sizes from 6 to 12 and 235 MDA/2 (U02350222Q) for the sizes from 13 to 19

Ø mm	b mm	L mm	code	
6	10	29,5	U02350101	1

## 235 3/8" M

O mm	b mm	L mm	code	
7	11,5	29,5	U02350102	1
8	13	29,5	U02356103	1
10	15	29,5	U02356105	1
11	17	29,5	U02356106	1
12	18	29,5	U02356107	1
13	19	29,5	U02356108	1
14	20	29,5	U02356109	1
15	22	29,5	U02356110	1
16	23,5	30	U02356111	1
17	25	30	U02356112	1
19	27	30	U02356114	1



## 235 1/2" M

ISO 2725-2

### Impact hexagonal sockets

- Special Chrome Molybdenum steel
- Phosphatised finish
- Employ safety pin 235 MCA/4 (U02350204Q) for the sizes from 8 to 21 and 235 MCA/6 (U02350206Q) for the sizes from 22 to 36
- Employ locking ring 235 MDA/4 (U02350224Q) for the sizes from 8 to 21 and 235 MDA/6 (U02350226Q) for the sizes from 22 to 36

O mm	b mm	L mm	code	
8	14,5	38	U02350224	1
9	16	38	U02350225	1
10	17	38	U02350201	1
11	18	38	U02350202	1
12	19	38	U02350203	1
13	20	38	U02350204	1
14	21,5	38	U02350205	1
15	23	38	U02350206	1
16	25	38	U02350207	1
17	26	38	U02350208	1
18	27	38	U02350209	1
19	30	38	U02350210	1
20	30	38	U02350211	1
21	32	38	U02350212	1
22	32	38	U02350213	1
23	34	42	U02350214	1
24	36	42	U02350215	1
26	38	42	U02350217	1
27	40	46	U02350218	1
28	40	46	U02350219	1
29	42	46	U02350220	1
30	42	46	U02350221	1
32	44	46	U02350222	1
36	50	50	U02350223	1



## 235 1/2" M/S7

### Set of 7 impact hexagonal sockets

- Supplied with plastic stands 559 1/2" and metal holder 559 B/250

pcs	description	item/size
7	Impact hexagonal sockets / 10-13-17-19-22-24-27	235 1/2 M

kg	code	
1	U02359254	1



## 235 1/2" M/C7

### Assortment with IMPACT hexagonal sockets in ABS case (7 pcs.)

- High resistance ABS case with quick closing system
- The inside tray is studied to be stored in USAG roller cabinet drawers
- Empty inner foam module: code U05191026Q

pcs	description	item/size
7	Impact hexagonal sockets / 10-13-14-17-19-22-24	235 1/2 M
1	Empty ABS case - size S	606 S

LxPxH mm	code	
210x130x60	U02359282	1



## 235 1/2" M/C16

### Assortment with IMPACT hexagonal sockets in modular box (16 pcs.)

- Compact plastic box
- Ergonomic integrated handle
- Double metal closing clip
- Empty box code: U02359285Q

pcs	description	item/size
15	Impact hexagonal sockets / 10-12-13-14-15-16-17-18-19-21-22-24-27-30-32	235 1/2 M
2	Lock pins	235 MCA/4-6
2	Safety rings	235 MDA/4-6
1	Impact extensions	236 1/2 M/125

LxPxH mm	code	
375x186x80	U02359285	1

## ISO 1174-2 ISO 691



**25% SHORTER**

Same performance of a standard impact socket 235 1/2 M.



## 235 1/2" M/C21

### Set of impact sockets in ABS case (18 pcs.)

- High resistance ABS case with quick closing system
- The inside tray is studied to be stored in USAG roller cabinet drawers
- Empty inner foam module: code U05191034Q

pcs	description	item/size
12	Impact hexagonal sockets / 10-11-12-13-14-15-16-17-18-19-22-24	235 1/2 M
6	Long impact hexagonal sockets with thin walls /15-17-19-21-22-24	235 1/2 MLS
2	Lock pins	235 MCA/4-6
2	Safety rings	235 MDA/4-6
1	Empty ABS case - size L	606 L

LxPxH mm	kg	code	
435x270x70	3	U02359281	1



## 235 1/2" MB

### Short impact hexagonal sockets

- Total length is 25% less than a standard impact socket 235 1/2 M
- Special Chrome Molybdenum steel
- Phosphatised finish
- Employ safety pin 235 MCA/4 (U02350204Q) for the sizes from 10 to 16, 235 MCA/5 (U02350205Q) for size 17 mm and 235 MCA/6 (U02350206Q) from 18 to 24
- Employ locking ring 235 MDA/4 (U02350224Q) for the sizes from 10 to 16, 235 MDA/5 (U02350225Q) from 17 to 19 and 235 MDA/6 (U02350226Q) from 21 to 24

O mm	b mm	L mm	code	
10	17	28	U02350510	1
11	18	28	U02350511	1
12	19	28	U02350512	1
13	20	28	U02350513	1
14	22	28	U02350514	1
15	23	28	U02350515	1
16	24	28	U02350516	1
17	26	28	U02350517	1
18	28	28	U02350518	1
19	28	28	U02350519	1
21	30	28	U02350521	1
22	22	28	U02350522	1
24	34	28	U02350524	1



## 235 1/2" MB/S7

### Set of 7 short impact hexagonal sockets

- Supplied with plastic stands 559 1/2" and metal holder 559 B/250

pcs	description	item/size
7	Short impact hexagonal sockets/10-13-17-19-21-22-24	235 1/2 MB

code	item/size
U02350531	1



1/2

## 235 1/2" MB/C10

### Assortment with short hexagonal impact sockets (10 pcs.)

- Compact plastic box  
- Metal closing clip  
- Empty box code: U02350530Q

pcs	description	item/size
10	Short impact hexagonal sockets / 10-11-12-13-14-15-16-17-18-19	235 1/2 MB

LxPxH mm	code	item/size
190x144x58	U02350530	1



3/4

## 235 3/4" M

ISO 2725-2

### Impact hexagonal sockets

- Special Chrome Molybdenum steel  
- Phosphatized finish  
- Employ safety pin 235 MCA/7 (U02350211Q) for the sizes from 17 to 32 and 235 MCA/8 (U02350207Q) for the sizes from 33 to 60  
- Employ locking ring 235 MDA/7 (U02350231Q) for the sizes from 17 to 32 and 235 MDA/8 (U02350227Q) for the sizes from 33 to 60

O mm	b mm	L mm	code	item/size
17	28,5	50	U02350301	1
18	29,5	50	U02350302	1
19	30,5	50	U02350303	1
21	34,5	52	U02350305	1
22	35	52	U02350306	1
23	38	52	U02350307	1
24	38	52	U02350308	1
26	41	52	U02350310	1
27	41	52	U02350311	1
28	44	52	U02350312	1
30	46	52	U02350313	1

## 235 3/4" M

O mm	b mm	L mm	code	item/size
32	48	52	U02350314	1
33	51	56	U02350324	1
34	51	56	U02350325	1
36	54	56	U02350315	1
38	56	56	U02350316	1
41	60	62	U02350317	1
46	67	63	U02350318	1
50	71	72	U02350319	1
55	82	74	U02350320	1
60	85	75	U02350321	1



3/4

## 235 3/4" M/C8

### Assortment with short hexagonal impact sockets (8 pcs.)

- Teflon protection that reduces the risk of damage to the alloy rims  
- Compact plastic box  
- Metal closing clip  
- Empty box code: U02359286Q

pcs	description	item/size
8	Impact hexagonal sockets / 21-22-24-27-30-32-36-41	235 1/2 M

LxPxH mm	code	item/size
375x186x80	U02359286	1



1

## 235 1" M

ISO 2725-2

### Impact hexagonal sockets

- Special Chrome Molybdenum steel  
- Phosphatized finish  
- Employ safety pin 235 MCA/9 (U02350208Q) for the sizes from 22 to 70  
- Employ locking ring 235 MDA/9 (U02350228Q) for the sizes from 22 to 70

O mm	b mm	L mm	code	item/size
22	40	60	U02350972	1
24	42	60	U02350973	1
27	44	60	U02350974	1
30	48	63	U02350975	1
32	50	63	U02350976	1
33	52	63	U02350964	1
36	56	65	U02350977	1
41	63	70	U02350965	1
46	68	70	U02350966	1
50	73	75	U02350967	1
55	80	80	U02350968	1
60	87	82	U02350969	1
65	93	87	U02350970	1
70	99	94	U02350971	1

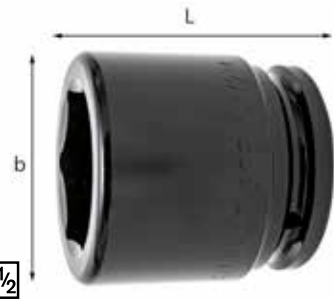

1 1/2

## 235 1 1/2" M

ISO 2725-2

### Impact hexagonal sockets

- Special Chrome Molybdenum steel  
- Phosphatized finish  
- Employ safety pin 235 MCA/10 (U02350209Q) for the sizes from 55 to 90 and 235 MCA/11 (U02350210Q) for the sizes from 95 to 120  
- Employ locking ring 235 MDA/10 (U02350229Q) for the sizes from 55 to 90 and 235 MDA/11 (U02350230Q) for the sizes from 95 to 120

O mm	b mm	L mm	code	item/size
55	87	90	U02350872	1
60	94	92	U02350873	1
65	100	95	U02350874	1
70	106	100	U02350875	1
75	112	103	U02350876	1
80	119	110	U02350877	1
85	125	118	U02350878	1
90	130	118	U02350879	1
95	137	118	U02350937	1
100	144	125	U02350945	1
105	150	125	U02350946	1
110	156	125	U02350947	1
115	162	135	U02350948	1
120	169	135	U02350949	1



1 1/2

## 235 1 1/2" ML

ISO 2725-2

### Long impact hexagonal sockets

- Special Chrome Molybdenum steel  
- Phosphatized finish  
- Employ safety pin 235 MCA/4 (U02350204Q) for the sizes from 10 to 21 and 235 MCA/6 (U02350206Q) for the sizes from 22 to 27  
- Employ locking ring 235 MDA/4 (U02350224Q) for the sizes from 10 to 21 and 235 MDA/6 (U02350226Q) for the sizes from 22 to 27

O mm	b mm	L mm	code	item/size
10	17	82	U02350240	1
13	20	82	U02350241	1
14	21,5	82	U02350242	1
16	25	82	U02350278	1
17	26	82	U02350243	1
18	27	82	U02350279	1
19	30	82	U02350244	1
21	32	82	U02350248	1
22	32	82	U02350245	1
24	36	82	U02350246	1
27	40	82	U02350247	1





**3/4**  
**235 3/4" ML** ISO 2725-2

**Long impact hexagonal sockets**

- Special Chrome Molybdenum steel
- Phosphatised finish
- Employ safety pin 235 MCA/8 (U02350207Q) for the sizes from 22 to 41
- Employ locking ring 235 MDA/8 (U02350227Q) for the sizes from 22 to 41

O mm	b mm	L mm	code	
22	35	85	U02350340	1
24	38	85	U02350341	1
27	41	85	U02350342	1
30	46	85	U02350343	1
32	48	85	U02350344	1
33	51	85	U02350347	1
36	54	85	U02350345	1
41	60	85	U02350346	1



**1/2**  
**235 1/2" MLS** ISO 691 ISO 1174-2

**Long impact hexagonal sockets with thin walls**

- Special Chrome Molybdenum steel
- Phosphatised finish
- Employ safety pin 235 MCA/4 (U02350204Q) for the size 15 and 235 MCA/6 (U02350206Q) for the sizes from 17 to 27
- Employ locking ring 235 MDA/4 (U02350224Q) for the size 15 and 235 MDA/6 (U02350226Q) for the sizes from 17 to 27

O mm	b mm	L mm	code	
15	22	85	U02350255	1
17	24	85	U02350256	1
19	26	85	U02350257	1
21	28	85	U02350258	1
22	30	85	U02350259	1
24	32	85	U02350260	1
27	36	85	U02350261	1



**3/4**  
**235 3/4" MLS** ISO 691 ISO 1174-2

**Long impact hexagonal sockets with thin walls**

- Special Chrome Molybdenum steel
- Phosphatised finish
- Employ safety pin 235 MCA/8 (U02350207Q) for the sizes from 22 to 36
- Employ locking ring 235 MDA/8 (U02350227Q) for the sizes from 22 to 36

O mm	b mm	L mm	code	
19	44	100	U02350269	1
22	33	100	U02350270	1
24	35	100	U02350271	1
27	39	100	U02350272	1
30	43	100	U02350273	1
32	45	100	U02350274	1
33	48	100	U02350275	1
36	51	100	U02350276	1



**1**  
**235 1" MLS** ISO 691 ISO 1174-2

**Long impact hexagonal sockets with thin walls**

- Special Chrome Molybdenum steel
- Phosphatised finish
- Employ safety pin 235 MCA/9 (U02350208Q) for the sizes from 27 to 36
- Employ locking ring 235 MDA/9 (U02350228Q) for the sizes from 27 to 36

O mm	b mm	L mm	code	
27	40	100	U02350280	1
30	46	100	U02350281	1
32	48	100	U02350282	1
33	50	100	U02350283	1
36	53	100	U02350284	1



**1/2**  
**235 1/2" MN** by **FACOM**

**Impact bihexagonal sockets**

- Special Chrome Molybdenum steel
- Phosphatised finish

O mm	b mm	L mm	code	
8	14,5	38	U02351008	1
9	15,6	38	U02351009	1
10	16,7	38	U02351010	1
11	18	38	U02351011	1
12	19	38	U02351012	1
13	20,2	38	U02351013	1
14	21,5	38	U02351014	1
15	23	38	U02351015	1
16	24,9	38	U02351016	1
17	25,9	38	U02351017	1
18	26,9	38	U02351018	1
19	29,9	38	U02351019	1
20	29,9	38	U02351020	1
21	31,7	38	U02351021	1
22	31,9	38	U02351022	1
23	33,9	42	U02351023	1
24	35,9	42	U02351024	1
26	37,9	42	U02351026	1
27	39,8	46	U02351027	1
28	39,8	46	U02351028	1
29	41,9	46	U02351029	1
30	41,9	46	U02351030	1
32	43,9	46	U02351032	1
34	45,8	46	U02351034	1
35	49,8	50	U02351035	1
36	49,8	50	U02351036	1



**3/4**  
**235 3/4" MN** by **FACOM**  
ISO 2725-2 ISO 1711-2 ASME B107.3

**Impact bihexagonal sockets**

- Special Chrome Molybdenum steel
- Phosphatised finish
- Employ safety pin 235 MCA/7 (U02350211Q) for the sizes 17÷46
- Employ locking ring 235 MDA/7 (U02350231Q) for the sizes 17÷46

O mm	b mm	L mm	code	
16	38	50	U02351116	1
17	30	50	U02351117	1
18	38	50	U02351118	1
19	32,5	50	U02351119	1
21	50	50	U02351120	1
22	36,5	50	U02351121	1
23	50	50	U02351122	1
24	50	50	U02351123	1
26	50	50	U02351124	1
27	50	50	U02351125	1
28	50	50	U02351128	1
29	50	50	U02351129	1
30	50	50	U02351130	1
32	50	50	U02351132	1
33	56	56	U02351133	1
34	56	56	U02351134	1
35	56	56	U02351135	1
36	56	56	U02351136	1
38	56	56	U02351138	1
41	62	62	U02351141	1
42	62	62	U02351142	1
46	63	63	U02351146	1



3/4

**235 3/4" MNL**

by **FACOM**

**Long impact bihexagonal sockets**

- Special Chrome Molybdenum steel
- Phosphatised finish
- Employ safety pin 235 MCA/7 (U02350211Q) for the sizes 17÷46
- Employ locking ring 235 MDA/7 (U02350231Q) for the sizes 17÷46

Ø mm	b mm	L mm	code	
17	28,6	85	U02353217	1
19	30	85	U02353219	1
21	34,5	85	U02351221	1
22	35	85	U02351222	1
23	38	85	U02351223	1
24	38	85	U02351224	1
26	40,9	85	U02351226	1
27	40,9	85	U02351227	1
29	43,9	85	U02351229	1
30	45,7	85	U02351230	1
32	48	85	U02351232	1
33	50,7	85	U02351233	1
34	50,7	85	U02351234	1
35	51,7	85	U02351235	1
36	53,7	85	U02351236	1
38	53,7	85	U02351238	1
41	60	85	U02351241	1
42	62	85	U02351242	1
46	67	85	U02351246	1



1/2

**235 1/2" MP**

by **FACOM**

**ASME B107.2**

**Impact hexagonal sockets, inch sizes**

- Special Chrome Molybdenum steel
- Phosphatised finish
- Employ safety pin 235 MCA/4 (U02350204Q) for the sizes 3/8-7/16-1/2-9/16-5/8-11/16-3/4-13/16 and 235 MCA/6 (U02350206Q) for the sizes 7/8-15/16-1-1-1/16
- Employ locking ring 235 MDA/4 (U02350224Q) for the sizes 3/8-7/16-1/2-9/16-11/16-13/16 and 235 MDA/6 (U02350226Q) for the sizes 5/8-3/4-7/8-15/16-1-1-1/16

Ø"	b mm	L mm	code	
7/16	18	38	U02351041	1
1/2	21	38	U02351042	1
9/16	22	38	U02351043	1
5/8	24	38	U02351044	1
11/16	26	38	U02351045	1
3/4	28	38	U02351046	1
13/16	30	38	U02351047	1
1	36	42	U02351050	1



3/4

**235 3/4" MP**

by **FACOM**

**ASME B107.2**

**Impact hexagonal sockets, inch sizes**

- Special Chrome Molybdenum steel
- Phosphatised finish
- Employ safety pin 235 MCA/7 (U02350211Q) for the sizes 3/4÷1-5/8
- Employ locking ring 235 MDA/7 (U02350231Q) for the sizes 3/4÷1-5/8

Ø"	b mm	L mm	code	
3/4	29,5	50	U02351250	1
13/16	32	50	U02351251	1
7/8	34	50	U02351252	1
15/16	36	50	U02351253	1
1	38	52	U02351254	1
1 1/16	42	52	U02351255	1
1 1/8	42	52	U02351256	1
1 1/4	46	55	U02351257	1
1 5/16	48	57	U02351258	1
1 7/16	52	57	U02351259	1
1 1/2	56	57	U02351260	1
1 5/8	58	63	U02351261	1

USAG socket wrenches are manufactured according to **ISO 2725-2** and **ISO 1174-2**, in special steel to have superior impact resistance; heat treated and burnished.

	3/8"	1/2"	3/4"	1"	1 1/2"
HEXAGONAL FEMALE	235 M	235 M, 235 ML, 235 MP, 235 MB	235 M, 235 MP, 235 ML	235 M, 235 ML	235 M
THIN WALLS		235 MLS	235 MLS	235 MLS	
BIHEXAGONAL FEMALE		235 MN	235 MN, 235 MNL		
HEXAGONAL MALE		234 MN			
TORX® MALE		233 MNTX	233 MSTX		
TORX® FEMALE		235 MTX, 235 MTXL	235 MTX		
XZN MALE		235 MXZN, 233 MXZNC	233 MSXZN		

**CAN'T YOU FIND THE SOCKET THAT YOU NEED?  
WE CAN MAKE IT!**

**We manufacture on request sockets and accessories.**

Send your request to:  
[prodotti.speciali@mygts.net](mailto:prodotti.speciali@mygts.net)





**235 1/2" MTX**  **ISO 1174-2**

**Impact TORX® sockets**

- Special Chrome Molybdenum steel
- Phosphatized finish
- Employ safety pin 235 MCA/4 (U02350204Q) for the sizes from E10 to E24
- Employ locking ring 235 MDA/4 (U02350224Q) for the sizes from E10 to E24

n°	b mm	L mm	code	
E10	13,2	38	U02350440	1
E12	14,6	38	U02350441	1
E14	16,5	38	U02350442	1
E16	19	38	U02350443	1
E18	21,5	38	U02350444	1
E20	23,5	38	U02350445	1
E24	28	45	U02350446	1



**235 1/2" MTX/S7** 

**Set of 7 impact TORX® sockets**

- Supplied with plastic stands 559 1/2" and metal holder 559 B/250

pcs	description	item/size
7	Impact TORX® sockets / E10-E12-E14-E16-E18-E20-E24	235 1/2 MTX

kg	code	
1	U02359270	1



**235 1/2" MTXL**  **by FAGOM**

**Long impact TORX® sockets**

- Special Chrome Molybdenum steel
- Phosphatized finish
- Employ safety pin 235 MCA/4 (U02350204Q) for the sizes E10÷E24
- Employ locking ring 235 MDA/4 (U02350224Q) for the sizes E10÷E24

n°	b mm	L mm	code	
E10	46,5	70	U02350450	1
E12	46,5	70	U02350451	1
E14	46,5	70	U02350452	1
E16	46,5	70	U02350453	1
E18	46,5	70	U02350454	1
E20	46,5	70	U02350455	1
E22	52	70	U02350456	1
E24	52	70	U02350457	1



**235 3/4" MTX**  **by FAGOM**

**Long impact TORX® sockets**

- Special Chrome Molybdenum steel
- Phosphatized finish
- Employ safety pin 235 MCA/8 (U02350207Q) for the sizes E18÷E24
- Employ locking ring 235 MDA/8 (U02350227Q) for the sizes E18÷E24

n°	b mm	L mm	code	
E18	70	100	U02351270	1
E20	70	100	U02351271	1
E22	70	100	U02351272	1
E24	70	100	U02351273	1



**235 MCA** **UNI ISO 2725-2**

**Lock pins**

n°	L mm	Ø mm	code	
1	14,8	2,5	U02350201Q	10
2	17,8	2,5	U02350202Q	10
3	19	2,5	U02350203Q	10
4	20	3	U02350204Q	10
5	22	3	U02350205Q	10
6	25	3	U02350206Q	10
7	31	4	U02350211Q	10
8	35	4	U02350207Q	10
9	45	5	U02350208Q	10
10	75	6	U02350209Q	10
11	84	6	U02350210Q	10



**235 MDA** **ISO 2725-2**

**Safety rings**

n°	Ø mm	b mm	code	
1	15	3,5	U02350221Q	10
2	18	3,5	U02350222Q	10
3	19	3,5	U02350223Q	10
4	20	4	U02350224Q	10
5	22	4	U02350225Q	10
6	25	4	U02350226Q	10
7	30	5	U02350231Q	10
8	36	5	U02350227Q	10
9	45	7	U02350228Q	10
10	74	10	U02350229Q	10
11	84	10	U02350230Q	10



**236 1/4"** **ISO 3316**

**Extensions**

- Special Chrome Vanadium steel
- Chrome plated finish

L mm	code	
50	U02360801	5
100	U02360802	5
150	U02360803	5



**236 3/8"** **ISO 3316**

**Extensions**

- Special Chrome Vanadium steel
- Chrome plated finish

L mm	code	
75	U02360000	5
125	U02360001	5
250	U02360002	5



**236 1/2"** **ISO 3316**

**Extensions**

- Special Chrome Vanadium steel
- Chrome plated finish

L mm	code	
75	U02360300	5
125	U02360201	5
250	U02360202	5



**236 3/4"** **ISO 3316**

**Extensions**

- Special Chrome Vanadium steel
- Chrome plated finish

L mm	code	
100	U02360400	5
200	U02360401	5
400	U02360402	5

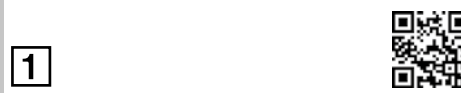

**236 1"** **ISO 3316**

**Extensions**

- Special Chrome Vanadium steel
- Chrome plated finish

L mm	code	
200	U02360601	1
415	U02360602	1



**236 3/8" TS** **ISO 1174-1**

**Angled extensions**

- Model with male square drive giving a working angle of 8° with respect to the axis of the socket
- Special Chrome Molybdenum steel
- Chrome plated finish

L mm	code	
75	U02360009	1
125	U02360007	1
250	U02360011	1

1/2

**236 1/2" TS**

ISO 1174-1

**Angled extensions**

- Model with male square drive giving a working angle of 8° with respect to the axis of the socket
- Special Chrome Molybdenum steel
- Chrome plated finish

L mm	code	
75	U02360015	1
125	U02360017	1
250	U02360018	1



1/4

**236 1/4" SN**

ISO 1174-1

**Flexible extension**

- Maximum permissible torsion 2,8 Nm
- Special Chrome Vanadium steel
- Flexible shaft to work on nuts difficult to reach
- Chrome plated finish

L mm	code	
150	U02360806	1



1/4

**236 K 1/4"**

ISO 1174-1

**Chain extension in Aluminium for sockets**

- Ideal to work in narrow spaces
- In the presence of obstacles, it allows the use of a manual ratchet or an impact wrench with greater working space
- When used with a manual ratchet, it multiplies the output revolutions by 1,5
- When used with an impact wrench, the impact frequency per minute increases by 20%
- Square drive maximum torque 62 Nm
- Aluminium body

LxH mm	g	code	
260x27	300	U02360698	1

1/2

**236 K 1/2"**

ISO 1174-1

**Chain extension in Aluminium for sockets**

- Ideal to work in narrow spaces
- In the presence of obstacles, it allows the use of a manual ratchet or an impact wrench with greater working space
- When used with a manual ratchet, it multiplies the output revolutions by 1,6
- When used with an impact wrench, the impact frequency per minute increases by 20%
- Square drive maximum torque 512 Nm
- Aluminium body

LxH mm	kg	code	
340x39	1,1	U02360700	1



1/2

**236 K/C13****Assortment with chain extension and impact sockets in ABS case (13 pcs.)**

- High resistance ABS case with quick closing system
- The inside tray is studied to be stored in USAG roller cabinet drawers
- Empty inner foam module: code U05190236Q

pcs	description	item/size
12	Impact hexagonal sockets / 10-11-12-13-14-15-16-17-18-19-22-24	235 1/2 M
1	Chain extension in Aluminium for sockets	236 K 1/2
1	Empty ABS case - size L	606 L

LxPxH mm	kg	code	
435x270x70	3	U02360852	1

1/2

**236 K/C20****Assortment with chain extension and hexagonal sockets in ABS case (20 pcs)**

- High resistance ABS case with quick closing system
- The inside tray is studied to be stored in USAG roller cabinet drawers
- Empty inner foam module: code U05190239Q

pcs	description	item/size
16	Hexagonal sockets /10-11-12-13-14-15-16-17-18-19-21-22-24-27-30-32	235 1/2 EN
1	Extensions	236 1/2/125
1	Chain extension in Aluminium for sockets	236 K 1/2
1	Reversible ratchet with sealed mechanism (certified IP51)	237 A 1/2
1	Universal joint	241 1/2
1	Empty ABS case - size L	606 L

LxPxH mm	kg	code	
435x270x70	4	U02360851	1



1/2

**236 KE 1/2"****Bit-holder chain extension in Aluminium**

- Hexagonal connection for IMPACT bits
- Use 1/2" hexagonal drive bits (USAG 687 range)
- Steel ring integrated in the hexagonal connection for a better hold of the bits during use
- Ideal for working in narrow spaces (e.g. for work on tensioners, pulleys, alternators)
- In the presence of obstacles, it allows the use of a manual ratchet or an impact wrench with greater working space
- When used with a manual ratchet, it multiplies the output revolutions by 1,6
- When used with an impact wrench, the impact frequency per minute increases by 20%
- Aluminium body



LxH mm	kg	code	
340x24	1,1	U02360705	1

**236 K for sockets****GREAT ACCESSIBILITY**  
HEAD DIMENSIONS AS A RATCHET\*.**39 mm**

\*Comparison with 1/2" ratchet.

**236 KE for bits****MINIMUM SIZE**  
DIRECT COUPLING FOR  
IMPACT BITS.Integrated  
spring steel ring.**USE WITH RATCHET OR IMPACT WRENCH**



## 236 KE 1/4"

### Bit-holder chain extension in Aluminium

- Hexagonal connection for IMPACT bits
- Use 1/2" hexagonal drive bits (USAG 660 range)
- Steel ring integrated in the hexagonal connection for a better hold of the bits during use
- Ideal for working in narrow spaces (e.g. for work on tensioners, pulleys, alternators)
- In the presence of obstacles, it allows the use of a manual ratchet or an impact wrench with greater working space
- When used with a manual ratchet, it multiplies the output revolutions by 1,6
- When used with an impact wrench, the impact frequency per minute increases by 20%
- Aluminium body



LxH mm	g	code	
260x19	300	U02360710	1



## 236 KE/C18

### Assortment with chain extension and impact bits in ABS case (18 pcs.)

- High resistance ABS case with quick closing system
- The inside tray is studied to be stored in USAG roller cabinet drawers
- Empty inner foam module: code U05191036Q

pcs	description	item/size
1	Bit-holder chain extension in Aluminium	236 KE 1/2
8	Impact bits for hexagonal screws - 1/2" connection / 5-6-8-10-12-14-17-19	687 E
9	Impact bits for TORX® screws - 1/2" connection / T25-T27-T30-T40-T45-T50-T55-T60-T70	687 TX
1	Empty ABS case - size L	606 L

LxPxH mm	code	
435x270x70	U02360890	1



## 236 KE/C22

### Assortment with short hexagonal impact sockets, extension wrench and impact bits (23 pcs.)

- Plastic box
- Ergonomic integrated handle
- Double metal closing clip
- Empty sheet steel box: code U02360900Q

pcs	description	item/size
7	Short impact hexagonal sockets / 13-14-15-16-17-18-19	235 1/2 MB
1	Bit-holder chain extension in Aluminium	236 KE 1/2
1	Adapter for impact sockets	236 KEADP
6	Impact bits for hexagonal screws - 1/2" connection / 5-6-8-10-12-14	687 E
7	Impact bits for TORX® screws - 1/2" connection / T25-T27-T30-T40-T45-T50-T55	687 TX

LxPxH mm	code	
415x283x92	U02360900	1



## 236 KEADP

### Adapter for impact sockets

- To be used with extension wrench 236 KE 1/2

L mm	code	
39	U02360901	1



## 236 3/8" M

ISO 1174-2

### Impact extensions

- Special Chrome Molybdenum steel
- Phosphatized finish
- Employ safety pin 235 MCA/1 (U02350201Q)
- Employ locking ring 235 MDA/1 (U02350221Q)

L mm	code	
75	U02360101	1
150	U02360104	1



## 236 1/2" M

ISO 1174-2

### Impact extensions

- Special Chrome Molybdenum steel
- Phosphatized finish
- Employ safety pin 235 MCA/4 (U02350204Q)
- Employ locking ring 235 MDA/4 (U02350224Q)

L mm	code	
75	U02360102	1
125	U02360306	1
250	U02360310	1



## 236 3/4" M

ISO 1174-2

### Impact extensions

- Special Chrome Molybdenum steel
- Phosphatized finish
- Employ safety pin 235 MCA/7 (U02350211Q) for the sizes 175-330 and 235 MCA/8 (U02350207Q) for the size 250
- Employ locking ring 235 MDA/7 (U02350231Q) for the sizes 175-330 and 235 MDA/8 (U02350227Q) for the size 250

L mm	code	
175	U02360410	1
250	U02360406	1
330	U02360420	1



## 236 1" M

ISO 1174-2

### Impact extensions

- Special Chrome Molybdenum steel
- Phosphatized finish
- Employ safety pin 235 MCA/9 (U02350208Q)
- Employ locking ring 235 MDA/9 (U02350228Q)

L mm	code	
125	U02360606	1
200	U02360607	1
330	U02360605	1



## 237 A 1/4"

ISO 3315

### Reversible ratchet with sealed mechanism (certified IP51)

- Model with 72 teeth and angle of action of 5°
- Knob-turn reversal system
- Sealed mechanism certified IP51
- Higher resistance in comparison to standard ratchets, because of the new patented pawl
- Forged steel body with double T section: lightness and resistance
- Conical bimaterial handle for safe and perfect grip
- Handle with hole for hanging on tool-holding panels
- Chrome plated finish

L mm	b mm	code	
120	24,3	U02370102	1



## D 237 A 1/4"

ISO 3315

### Reversible ratchet with sealed mechanism (certified IP51)

L mm	b mm	code	
120	24,3	U02370102D	1

3/8



### 237 A 3/8"

ISO 3315

**Reversible ratchet with sealed mechanism (certified IP51)**

L mm	b mm	code	
180	29,7	U02370104	1

1/2



### 237 A 1/2"

ISO 3315

**Reversible ratchet with sealed mechanism (certified IP51)**

L mm	b mm	code	
260	38,4	U02370106	1



1/2



### D 237 A 1/2"

ISO 3315

**Reversible ratchet with sealed mechanism (certified IP51)**

L mm	b mm	code	
260	38,4	U02370106D	1



3/4

### 237 A 3/4"

ISO 3315

**Reversible ratchet**

- Model with 72 teeth and angle of action of 5° for working in restricted spaces
- Knob-turn reversal system
- Ergonomic bimaterial handle
- Special Chrome Vanadium steel body
- Chrome plated finish

L mm	b mm	code	
515	60	U02370008	1



### 237 AR 3/4"

**Spare parts kit**

- For ratchets 237 A 3/4"

Kg	code	
1	U02370125Q	1



1/4



### 237 1/4" AK

ISO 3315

**Reversible ratchet with revolving handle**

- Model with 60 teeth and angle of action of 6° for working in restricted spaces
- Knob-turn reversal system
- Socket releasing button
- Ergonomic bimaterial handle
- Revolving grip for exceptional accessibility



L mm	b mm	code	
120	22,4	U02370003	1



1/2



### 237 1/2" AK

ISO 3315

**Reversible ratchet with revolving handle**

- Model with 60 teeth and angle of action of 6° for working in restricted spaces
- Knob-turn reversal system
- Socket releasing button
- Ergonomic bimaterial handle
- Revolving grip for exceptional accessibility



L mm	b mm	code	
260	41	U02370009	1



1/4



### 237 B 1/4"

ISO 3315

**Reversible ratchet with sealed mechanism**

- Model with 72 teeth and angle of action of 5°
- Sealed mechanism with one-piece forged steel head
- One-hand operating inversion lever
- Can be used with two hands pushing on the ratchet head
- Forged steel body with double T section: lightness and resistance
- Conical bimaterial handle for safe and perfect grip
- Handle with hole for hanging on tool-holding panels
- Chrome plated finish



L mm	b mm	code	
120	22	U02370112	1



## 237 A

Reversible ratchet



YouTube



**Certified IP51**  
Head mechanism protected from dust and water.



**Patented internal mechanism**  
Lasts longer than any other ratchet.



**Head thickness reduced**  
Better accessibility.

**3/8****237 B 3/8"**

ISO 3315

**Reversible ratchet with sealed mechanism**

L mm	b mm	code	
210	29	U02370114	1

**1/2****237 B 1/2"**

ISO 3315

**Reversible ratchet with sealed mechanism**

L mm	b mm	code	
260	38	U02370116	1

**3/4****237 B 3/4"**

ISO 3315

**Reversible ratchet with sealed mechanism**

- Model with 120 teeth and angle of action of 3°
- Sealed mechanism with one-piece forged steel head
- One-hand operating inversion lever
- Can be used with two hands pushing on the ratched head
- Forged steel body with double T section: lightness and resistance
- Conical bimaterial handle for safe and perfect grip
- Handle with hole for hanging on tool-holding panels
- Chrome plated finish

L mm	b mm	code	
510	60	U02370119	1

**1/4****237 1/4" BP**

ISO 3315

**Reversible ratchet with socket retaining system**

- Model with 72 teeth and angle of action of 5° for working in narrow spaces
- One-hand operating inversion lever
- Socket releasing button
- Conical bimaterial handle for safe and strong grip
- Sealed mechanism
- Forged steel body with double T section: lightness and resistance
- Handle with hole for hanging on tool-holding panels
- Chrome plated finish



L mm	b mm	code	
120	22	U02370122	1

**1/2****237 1/2" BP**

ISO 3315

**Reversible ratchet with socket retaining system**

L mm	b mm	code	
260	38	U02370126	1



NEW

**1/4****237 C 1/4"**

ISO 3315

**Reversible ratchet**

- Model with 72 teeth and angle of action of 5°
- Knob-turn reversal system
- Forged steel body with double T section: lightness and resistance
- Ergonomic high resistant ABS handle
- Handle with hole for hanging on tool-holding panels
- Chrome satin finish

L mm	b mm	code	
120	24,3	U02370132	1

**1/2****237 C 1/2"**

ISO 3315

**Reversible ratchet**

L mm	b mm	code	
260	38,4	U02370136	1

**1/4****237 D 1/4"**

ISO 3315

**Sliding square ratchet**

- Model with 60 teeth and angle of action of 6°
- Reversion system with sliding square
- Pushing the square and turning 180° you can change working sense
- Forged steel body with double T section: lightness and resistance
- Conical bimaterial handle for safe and perfect grip
- Handle with hole for hanging on tool-holding panels
- Chrome plated finish

L mm	b mm	code	
121	24	U02370053	1

**3/8****237 D 3/8"**

ISO 3315

**Sliding square ratchet**

L mm	b mm	code	
201	32	U02370055	1

**1/2****237 D 1/2"**

ISO 3315

**Sliding square ratchet**

L mm	b mm	code	
262	41	U02370057	1

**3/4****237 D 3/4"**

ISO 3315

**Simple ratchet with sliding square drive**

- Model with 60 teeth and angle of action of 6° for working in narrow spaces
- Ergonomic bimaterial handle
- Special Chrome Vanadium steel body
- Chrome plated finish

L mm	b mm	code	
515	60	U02370058	1

**3/8****237 E 3/8"**

ISO 3315

**Empty square ratchet**

- Model with 60 teeth and angle of action of 6°
- Forged steel body with double T section: lightness and resistance
- Conical bimaterial handle for safe and perfect grip
- Handle with hole for hanging on tool-holding panels
- Chrome plated finish

L mm	b mm	code	
200	32	U02370045	1

**1/2****237 E 1/2"**

ISO 3315

**Empty square ratchet**

L mm	b mm	code	
262	41	U02370047	1

**3/4****237 E 3/4"**

ISO 3315

**Simple ratchet with female square drive**

- Model with 60 teeth and an angle of action of 6° for working in narrow spaces
- Ergonomic bimaterial handle
- Special Chrome Vanadium steel body
- Chrome plated finish

L mm	b mm	code	
515	60	U02370048	1



**1/4**  
**237 DRA 1/4"**

**Spare parts kit**

- For ratchets 237 1/4" D

kg	code	
1	U02370042Q	1



**3/8**  
**237 DRA 3/8"**

**Spare parts kit**

- For ratchets 237 D 3/8" and 237 E 3/8"

kg	code	
1	U02370043Q	1



**1/2**  
**237 DRA 1/2"**

**Spare parts kit**

- For ratchets 237 D 1/2" and 237 E 1/2"

kg	code	
1	U02370044Q	1



**3/4**  
**237 DRA 3/4"**

**Spare parts kit**

- For ratchets 237 D 3/4" and 237 E 3/4"

kg	code	
1	U02370045Q	1



**3/8**  
**237 DRB 3/8"**

**Spare square drive**

- For ratchets 237 D 3/8" and 237 E 3/8"

gr	code	
19	U02370053Q	1



**1/2**  
**237 DRB 1/2"**

**Spare square drive**

- For ratchets 237 D 1/2" and 237 E 1/2"

gr	code	
44	U02370054Q	1



**3/4**  
**237 DRB 3/4"**

**Spare square drive**

- For ratchets 237 D 3/4" and 237 E 3/4"

gr	code	
137	U02370055Q	1



**1/2**  
**237 FB 1/2"**

ISO 1174-1

**Hinged extendable ratchet**

- Possibility to extend the length up to more than 70% of a standard ratchet
- Length regulation system on the handle
- 180 ° swivel head
- Model with 72 teeth and 5° angle action
- Inversion system with integrated lever
- Sealed mechanism
- Socket releasing button
- Conical bimaterial handle
- Handle with a hole for hanging on tool-holding panels
- Chrome plated finish

L max mm	L min mm	b mm	gr	code	
437	304	38	830	U02370070	1



**237 1/4" FK**

**Reversible ratchet for short sockets**

- Contained in the assortment 610 1/4 EFK
- 180 ° swivel head
- Inversion system with integrated lever
- 11 mm bihexagonal opening with holding ring for the short sockets

L mm	a mm	code	
115	22	U02370061	1



**1/4**  
**237 JA 1/4"**

**NEW**  
ISO 3315

**Reversible ratchet 1/4**

- Model with 72 teeth and angle of action of 5°
- Knob-turn reversal system
- Forged steel body with handle integrated in the mold
- Chrome plated finish

L mm	a mm	code	
145	24,5	U02370142	1



**1/2**  
**237 JA 1/2"**

**NEW**  
ISO 3315

**Reversible ratchet 1/2**

L mm	a mm	code	
246	38,5	U02370146	1



**1/4**  
**237 JR 1/4"**

**Spare parts kit**

- For 1/4 ratchets of assortments 601 1/4 J34, 601 1/4-1/2 J82, 601 1/4-1/2 J100 and 002 JMA, 002 JTMA, 002 JMP

gr	code	
20	U02370012Q	1



**1/2**  
**237 JR 1/2"**

**Spare parts kit**

- For 1/2 ratchets of assortments 601 1/2 J22, 601 1/4-1/2 J82, 601 1/4-1/2 J100, 002 JMA and 002 JTMA

gr	code	
30	U02370016Q	1



**3/4**  
**237 3/4" SI**

ISO 3315

**Reversible ratchet**

- Model with 30 teeth for use in combination with handle 237 3/4" PR
- Special Chrome Vanadium steel body
- Chrome plated and phosphatized finish

L mm	b mm	d mm	H mm	code	
530	70	165	55	U02370403	1



**1**  
**237 1" SI**

ISO 3315

**Reversible ratchet**

- Model with 30 teeth for use in combination with handle 237 1" PR
- Special Chrome Vanadium steel body
- Chrome plated and phosphatized finish

L mm	b mm	d mm	H mm	code	
650	72	205	65	U02370603	1



**3/4**  
**237 3/4" PR**

**Handle**

- For use in combination with ratchet 237 3/4" SI
- Plastic handle
- Special Chrome Vanadium steel
- Chrome plated finish

Ø mm	L mm	code	
20	450	U02370404	1



**1****237 1" PR****Handle**

- For use in combination with ratchet 237 1" SI
- Plastic handle
- Special Chrome Vanadium steel
- Chrome plated finish

Ø mm	L mm	code	
25	540	U02370604	1

**1/2****239 1/2" N**

ISO 3315

**Speed brace with revolving handle**

- Plastic handle
- Special Chrome Vanadium steel
- Chrome plated finish

L mm	b mm	code	
405	120	U02390004	2

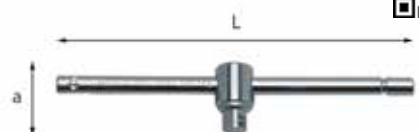
**1/4****240 1/4" N**

ISO 3315

**T-handle with sliding square drive**

- Special Chrome Vanadium steel
- Chrome plated finish

L mm	a mm	code	
115	22,5	U02400301	5

**3/8****240 3/8" N**

ISO 3315

**T-handle with sliding square drive**

- Special Chrome Vanadium steel
- Chrome plated finish

L mm	a mm	code	
200	35	U02400003	5

**1/2****240 1/2" N**

ISO 3315

**T-handle with sliding square drive**

- Special Chrome Vanadium steel
- Chrome plated finish

L mm	a mm	code	
280	45	U02400004	5

**3/4****240 3/4" N**

ISO 3315

**T-handle with sliding square drive**

- Special Chrome Vanadium steel
- Chrome plated finish

L mm	a mm	code	
425	62	U02400005	2

**1****240 1" N**

ISO 3315

**T-handle with sliding square drive**

- Special Chrome Vanadium steel
- Chrome plated finish

L mm	a mm	code	
500	80	U02400006	1

**1/4****241 1/4" N**

ISO 3315

**Universal joint**

- Friction-spring to allow presetting of socket at the desired angle
- Special Chrome Vanadium steel
- Chrome plated finish

L mm	a mm	code	
40	14	U02410301	2

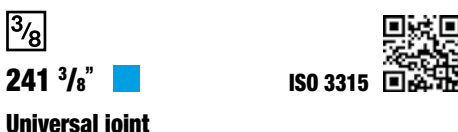
**3/8****241 3/8" N**

ISO 3315

**Universal joint**

- Friction-spring to allow presetting of socket at the desired angle
- Special Chrome Vanadium steel
- Chrome plated finish

L mm	a mm	code	
55	18	U02410001	2

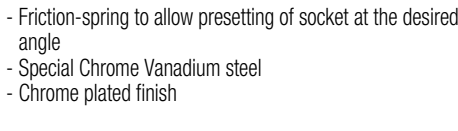
**1/2****241 1/2" N**

ISO 3315

**Universal joint**

- Friction-spring to allow presetting of socket at the desired angle
- Special Chrome Vanadium steel
- Chrome plated finish

L mm	a mm	code	
68	24	U02410201	2

**3/4****241 3/4" N**

ISO 3315

**Universal joint**

- Friction-spring to allow presetting of socket at the desired angle
- Special Chrome Vanadium steel
- Chrome plated finish

L mm	a mm	code	
105	39,5	U02410401	2

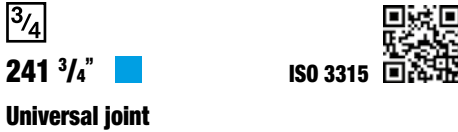
**3/8****241 3/8" MN**

ISO 1174-2

**Impact universal joint**

- Special Chrome Molybdenum steel
- Phosphatized finish
- Employ safety pin 235 MCA/3 (U02350203Q)
- Employ locking ring 235 MDA/3 (U02350223Q)

L mm	a mm	code	
51	22	U02410403	1

**1/2****241 1/2" MN**

ISO 1174-2

**Impact universal joint**

- Special Chrome Molybdenum steel
- Phosphatized finish
- Employ safety pin 235 MCA/5 (U02350205Q)
- Employ locking ring 235 MDA/5 (U02350225Q)

L mm	a mm	code	
62	30	U02410404	1

**3/4****241 3/4" MN**

ISO 1174-2

**Impact universal joint**

- Special Chrome Molybdenum steel
- Phosphatized finish
- Employ safety pin 235 MCA/8 (U02350207Q)
- Employ locking ring 235 MDA/8 (U02350227Q)

L mm	a mm	code	
89	44	U02410405	1

**1****241 1" MN**

ISO 1174-2

**Impact universal joint**

- Special Chrome Molybdenum steel
- Phosphatized finish
- Employ safety pin 235 MCA/9 (U02350208Q)
- Employ locking ring 235 MDA/9 (U02350228Q)

L mm	a mm	code	
113,5	54	U02410406	1





1/2

**241 1 1/2" MN**

by **FRACOM**  
**ASME B107.2**

**Impact universal joint**

- Special Chrome Molybdenum steel
- Phosphatised finish
- Employ safety pin 235 MCA/10 (U02350209Q)
- Employ locking ring 235 MDA/10 (U02350229Q)

L mm	a mm	code	
181	86	U02410407	1



1/4

**243 1/4"**

**ISO 3315**

**Spinner with handle**

- Ergonomic three-material grip
- Chrome Vanadium steel blade
- Chrome plated finish

L mm	a mm	code	
170	50	U02430202	5



1/4

**243 C 1/4"**

**ISO 3315**

**Spinner with handle**

- Ergonomic three-material grip
- Chrome Vanadium steel blade
- Chrome plated finish

L mm	a mm	handle size	code	
130	15	M2	U02430201	5



1/4

**D 243 C 1/4"**

**Spinner with handle**

L mm	a mm	code	
170	50	U02430201D	1



1/4

**243 1/4" SN**

**ISO 1174-1**

**Flexible spinner with handle**

- Maximum permissible torsion 2,8 Nm
- Ergonomic three-material grip
- Chrome Vanadium steel blade
- Flexible shaft to work on nuts difficult to reach
- Square drive and blade Nickel plated finish

L mm	a mm	handle size	code	
270	150	M4	U02430211	5

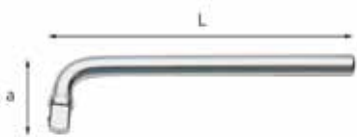

3/4

**244 3/4"**

**ISO 3315**

**Offset handle**

- Special Chrome Vanadium steel
- Chrome plated finish

L mm	a mm	code	
265	70	U02440401	2



1/2

**245 1/2" N**

**ISO 3315**

**Socket drivers with hinged square drive**

- Ergonomic bimaterial handle
- Special Chrome Vanadium steel
- Chrome plated finish

L mm	code	
380	U02450106	1
460	U02450107	1



1/2

**245 A 1/2"**

**ISO 3315**

**Hinged extendable swivel handle**

- Possibility to extend into 7 different positions
- System for length adjustment
- 180° swivel head
- Conical bimaterial handle
- Handle with hole for hanging on tool-holding panels
- Chrome plated finish

L max mm	L min mm	gr	code	
413	280	670	U02450003	1



3/8

**246 3/8"**

**ISO 3316**

**Adapter**

- Maximum permissible torsion 62 Nm
- Special Chrome Molybdenum steel
- Chrome plated finish

"	"	L mm	a mm	code	
3/8	1/4	25	18	U02460001	5

1/2

**246 1/2"**

**ISO 3316**

**Adapter**

- Maximum permissible torsion 202 Nm
- Special Chrome Vanadium steel
- Chrome plated finish

"	"	L mm	a mm	code	
1/2	3/8	37	22	U02460201	5



3/4

**246 3/4"**

**ISO 3316**

**Adapter**

- Maximum permissible torsion 512 Nm
- Model with interchangeable male square drive
- Special Chrome Vanadium steel
- Chrome plated finish

"	"	L mm	a mm	code	
3/4	1/2	58	37	U02460301	5

1

**246 1"**

**ISO 3316**

**Adapter**

- Maximum permissible torsion 1412 Nm
- Model with interchangeable male square drive
- Special Chrome Vanadium steel
- Chrome plated finish

"	"	L mm	a mm	code	
1	3/4	74	42	U02460404	1



3/4

**246 R3**

**Spare square drive**

- For adapters 246 3/4"

"	L mm	code	
1/2	30	U02460030Q	1

**1****246 R4****Spare square drive**

- For adapters 246 1"

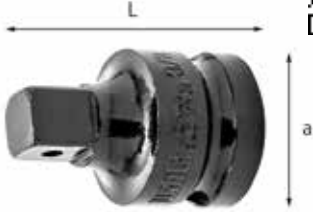

"	"	L mm	a mm	code	
3/4		U02460040Q	1		

**1/2****246 1/2" M**

ISO 1174-2

**Impact adapter**

- Maximum permissible torsion 202 Nm
- Special Chrome Molybdenum steel
- Phosphatized finish
- Employ safety pin 235 MCA/4 (U02350204Q)
- Employ locking ring 235 MDA/4 (U02350224Q)

"	"	L mm	a mm	code	
1/2	3/8	38	25	U02460202	1

**3/4****246 3/4" M**

ISO 1174-2

**Impact adapter**

- Maximum permissible torsion 512 Nm
- Special Chrome Molybdenum steel
- Phosphatized finish
- Employ safety pin 235 MCA/8 (U02350207Q)
- Employ locking ring 235 MDA/8 (U02350227Q)

"	"	L mm	a mm	code	
3/4	1/2	56	44	U02460402	1

**1****246 1" M**

ISO 1174-2

**Impact adapter**

- Maximum permissible torsion 1412 Nm
- Special Chrome Molybdenum steel
- Phosphatized finish
- Employ safety pin 235 MCA/9 (U02350208Q)
- Employ locking ring 235 MDA/9 (U02350228Q)

"	"	L mm	a mm	code	
1	3/4	75	54	U02460602	1

**1 1/2****246 1 1/2" M**

ISO 1174-2

**Impact adapter**

- Maximum permissible torsion 2515 Nm
- Special Chrome Molybdenum steel
- Phosphatized finish
- Employ safety pin 235 MCA/10 (U02350209Q)
- Employ locking ring 235 MDA/10 (U02350229Q)

"	"	L mm	a mm	code	
1 1/2	1	100	86	U02460702	1

**1/4****247 1/4"**

ISO 3316

**Adapter**

- Special Chrome Vanadium steel
- Chrome plated finish

"	"	L mm	a mm	code	
1/4	3/8	25	12	U02470004	5

**3/8****247 3/8"**

ISO 3316

**Adapter**

- Special Chrome Vanadium steel
- Chrome plated finish

"	"	L mm	a mm	code	
3/8	1/2	35	18	U02470003	5

**1/2****247 1/2"**

ISO 3316

**Adapter**

- Special Chrome Vanadium steel
- Chrome plated finish

"	"	L mm	a mm	code	
1/2	3/4	47	25	U02470001	5

**3/4****247 3/4"**

ISO 3316

**Adapter**

- Special Chrome Vanadium steel
- Chrome plated finish

"	"	L mm	a mm	code	
3/4	1	67	36	U02470002	2

**3/8****247 3/8" M**

ISO 1174-2

**Impact adapter**

- Special Chrome Molybdenum steel
- Phosphatized finish
- Employ safety pin 235 MCA/2 (U02350202Q)
- Employ locking ring 235 MDA/2 (U02350222Q)

"	"	L mm	a mm	code	
3/8	1/2	32	22	U02470007	1

**1/2****247 1/2" M**

ISO 1174-2

**Impact adapter**

- Special Chrome Molybdenum steel
- Phosphatized finish
- Employ safety pin 235 MCA/6 (U02350206Q)
- Employ locking ring 235 MDA/6 (U02350226Q)

"	"	L mm	a mm	code	
1/2	3/4	48	30	U02470008	1

**3/4****247 3/4" M**

ISO 1174-2

**Impact adapter**

- Special Chrome Molybdenum steel
- Phosphatized finish
- Employ safety pin 235 MCA/8 (U02350207Q)
- Employ locking ring 235 MDA/8 (U02350227Q)

"	"	L mm	a mm	code	
3/4	1	63	44	U02470010	1

**1****247 1" M**

ISO 1174-2

**Impact adapter**

- Special Chrome Molybdenum steel
- Phosphatized finish
- Employ safety pin 235 MCA/9 (U02350208Q)
- Employ locking ring 235 MDA/9 (U02350228Q)

"	"	L mm	a mm	code	
1	1 1/2	90	54	U02470011	1

**1 1/2****247 1 1/2" M**by **ASME B107.2****Impact adapter**

- Special Chrome Molybdenum steel
- Phosphatized finish
- Employ safety pin 235 MCA/10 (U02350209Q)
- Employ locking ring 235 MDA/10 (U02350229Q)

"	"	L mm	a mm	code	
1 1/2	2 1/2	120	60	U02470012	1





## 252 N/SE10

### Set of 13 double ended open jaw wrenches

pcs	description	item/size
10	Double ended open jaw wrenches / 6x7-8x9-10x11-12x13-14x15-16x17-18x19-20x22-24x27-30x32	252 N
1	Empty plastic display stand	252 ASV13

code	item/size
U02520870	1



## 252 N/B8

### Set of 8 double ended open jaw wrenches

- Supplied in plastic pouch
- Heads angled at 15°
- Chrome Vanadium steel
- Chrome plated finish

pcs	description	item/size
8	Double ended open jaw wrenches /6x7-8x9- 252 N 10x11-12x13-14x15-16x17-18x19-20x22	

gr	code	item/size
900	U02520865	1



## 252 N/B12

### Set of 12 double ended open jaw wrenches

- Supplied in plastic pouch
- Heads angled at 15°
- Chrome Vanadium steel
- Chrome plated finish

pcs	description	item/size
12	Double ended open jaw wrenches /6x7-8x9- 252 N 10x11-12x13-14x15-16x17-18x19-20x22-21x23-24x27-25x28-30x32	

Kg	code	item/size
2,4	U02520866	1



## 252 N/B13

### Set of 13 double ended open jaw wrenches

- Supplied in plastic pouch
- Heads angled at 15°
- Chrome Vanadium steel
- Chrome plated finish

pcs	description	item/size
13	Double ended open jaw wrenches /6x7-8x9- 252 N 10x11-12x13-14x15-16x17-18x19-20x22-21x23-24x26-25x28-27x29-30x32	

Kg	code	item/size
3	U02520867	1



## 252 NVB

### Empty pouch

- For wrench set 252 N/B8

code	item/size
U02520506	1



## 252 NVB12

### Empty pouch

- For wrench set 252 N/B12, 252 N/B13

code	item/size
U02520507	1



## 252 N/SR8

### Set of 8 double ended open jaw wrenches

- Supplied with plastic stand
- Heads angled at 15°
- Chrome Vanadium steel
- Chrome plated finish

pcs	description	item/size
8	Double ended open jaw wrenches /6x7-8x9- 252 N 10x11-12x13-14x15-16x17-18x19-20x22	

gr	code	item/size
900	U02520862	1



## 252 N/SR13

### Set of 13 double ended open jaw wrenches

- Supplied with plastic stand
- Heads angled at 15°
- Chrome Vanadium steel
- Chrome plated finish

pcs	description	item/size
13	Double ended open jaw wrenches /6x7-8x9- 252 N 10x11-12x13-14x15-16x17-18x19-20x22-21x23-24x26-25x28-27x29-30x32	

Kg	code	item/size
2,8	U02520864	1



## 252 ASV8

### Empty plastic display stand

- For wrench set 252 N/SR8, 285 KB/SR8

gr	code	item/size
60	U02520001Q	1



## 252 ASV13

### Empty plastic display stand

- For wrench set 252 N/SR13

gr	code	item/size
105	U02520002Q	1



## 252 N/R13

### Set of 13 double ended open jaw wrenches

- Supplied with metal holder
- Heads angled at 15°
- Chrome Vanadium steel
- Chrome plated finish

pcs	description	item/size
13	Double ended open jaw wrenches /6x7-8x9- 252 N 10x11-12x13-14x15-16x17-18x19-20x22-21x23-24x26-25x28-27x29-30x32	

Kg	code	item/size
2,9	U02520868	1



## 252 RV13

### Empty holder for double ended open jaw wrenches

- Enamelled sheet steel
- Supplied without screws

L mm	gr	code	item/size
325	260	U02520502	1





## 255 N/SE8

### Set of 8 bihexagonal ring wrenches

pcs	description	item/size
8	Straight double ended bihexagonal ring wrenches/ 255 N 6x7-8x9-10x11-12x13-14x15-16x17-18x19-22x24	

kg	code	
500	U02550260	1



## 255 N/SE12

### Set of 12 bihexagonal ring wrenches

pcs	description	item/size
12	Straight double ended bihexagonal ring wrenches/ 6x7-8x9-10x11-12x13-14x15-16x17-18x19-21x23-22x24-26x28-27x29-30x32	255 N

kg	code	
1,5	U02550261	1



## 255 TX

### Straight double ended TORX® wrenches

- Heads with patented high resistance profile
- TORX® profile rotated 15° with respect to the axis of the wrench, to allow a grip at an angle of only 30° by reversing the wrench

n°	L mm	code	
E6xE8	115	U02550303	1
E10xE12	150	U02550304	1
E14xE18	190	U02550305	1
E20xE24	240	U02550306	1



## 255 TX/S4

### Set of 4 straight double ended TORX® wrenches

pcs	description	item/size
4	Straight double ended TORX® wrenches / E6xE8-E10xE12-E14xE18-E20xE24	255 TX

kg	code	
300	U02550300	1



## 256 AN

ISO 691

### Wrenches with retainer for connectors

- Straight heads hexagonal profile
- Retainer to give improved grip on the nut during operations

Ø mm	L mm	code	
8x10	125	U02560061	2
10x11	127	U02560062	2
11x13	143	U02560063	2
12x14	145	U02560064	2
17x19	164	U02560065	2



## 256 AN/S5

### Set of 5 wrenches for connectors

- Supplied in nylon pouch
- Straight heads hexagonal profile
- Retainer to give improved grip on the nut during operations

pcs	description	item/size
5	Wrenches with retainer for connectors / 8x10-10x11-11x13-12x14-17x19	256 AN
1	Empty pouch	256 A/SEV5

kg	code	
400	U02560151	1



## 256 A/SEV5

### Empty pouch

- For wrench set 256 AN/S5

code	
U02560030	1



## 256 N

ISO 691 DIN 3118

### Wrenches for connectors

- Heads bent at 15° and angled laterally to 15°
- Hexagonal profile up to size 12x14 mm and bihexagonal profile for larger sizes

Ø mm	L mm	code	
8x10	140	U02560041	2
10x11	153	U02560042	2
11x13	174	U02560043	2
12x14	174	U02560044	2
17x19	203	U02560045	2
19x22	228	U02560046	2
22x24	243	U02560047	2
24x27	257	U02560048	2
30x32	296	U02560049	2
36x41	316	U02560050	1



## 256 N/SE7

### Set of 7 wrenches for connectors

pcs	description	item/size
7	Wrenches for connectors /8x10-10x11-11x13-12x14-17x19-19x22-24x27	256 N

kg	code	
1	U02560150	1



## 257 3/8"

ISO 691 ISO 1174-1

### Crow-foot wrenches

- For working on locknuts, threaded plugs, bulbs, sensors, and other mechanical items that are difficult to reach
- Special Chrome Vanadium steel
- Chrome plated finish

Ø mm	L mm	a mm	code	
8	34	25	U02570001	1
9	34	25	U02570002	1
10	34	25	U02570003	1
11	34	25	U02570004	1
12	37	30	U02570005	1
13	37	30	U02570006	1
14	37	30	U02570007	1
15	43	38	U02570008	1
16	43	38	U02570009	1
17	43	38	U02570010	1
19	45	41	U02570012	1
20	45	41	U02570013	1
21	45	41	U02570014	1
22	50	46	U02570015	1
24	53	50	U02570017	1



## 257 3/8" SE15

### Set of 15 crow-foot wrenches

pcs	description	item/size
15	Crow-foot wrenches /8-9-10-11-12-13-14-15-16-17-19-20-21-22-24	257 3/8

kg	code	
700	U02570081	1



## 258 N ISO 691 ISO 3318

### Special double ended bihexagonal ring wrenches

- For use on nuts in inaccessible places: starters, manifolds and other engine parts

Ø mm	d mm	L mm	code	
10x12	54,1	143	U02580300	1
11x13	66,6	165	U02580301	1
14x17	79,2	190	U02580302	1
15x17	81,3	220	U02580303	1
16x18	81,3	220	U02580304	1
19x22	94,3	253	U02580305	1



## 258 N/SE5

### Set of 5 bihexagonal ring wrenches

pcs	description	item/size
5	Special double ended bihexagonal ring wrenches/ 10x12-11x13-15x17-16x18-19x22	258 N

à gr	code	
900	U02580350	1



## 260

### Ratchet wrenches for connectors

- For rapid tightening without removing the wrench from the nut  
- Hexagonal shape till 10 mm

Ø mm	L mm	code	
8	138	U02600008	1
10	138	U02600010	1
11	138	U02600011	1
12	138	U02600012	1
13	138	U02600013	1
14	184	U02600014	1
16	184	U02600016	1
17	184	U02600017	1
19	184	U02600019	1
22	236	U02600022	1
24	236	U02600024	1



## 260 SE11

### Set of 11 ratchet wrenches for connectors

pcs	description	item/size
11	Ratchet wrenches for connectors / 8-10-11-12-13-14-16-17-19-22-24	260

à Kg	code	
1,5	U02600185	1



## 3/8

## 263/S16

### Oil draining kit (16 pcs.)

- Complete kit for the most part of vehicles
- Magnetic sockets to hold plugs
- 3/8" hinged wrench for exceptional accessibility
- Protection cup to keep hands clean and prevent contact with oil and hydrocarbons
- Supplied with working support with fixing clip to be secured on the arm of oil trays
- Contents:
  - 1 hinged wrench 3/8"
  - 2 bits 8-10 mm 3/8"
  - 6 bits 8-10-12-13-14-17 mm 3/8"
  - 6 hexagonal sockets 13-14-17-18-19-21 mm 3/8"
  - 1 TORX® bit T45

LxPxH mm	à Kg	code	
310x280x50	1,3	U02631400	1



## 3/8

## 263 K

### Hinged wrench for oil draining

- 3/8" square drive
- Hinged wrench for great manoeuvrability
- The protection cup prevents hand contact with oil or hydrocarbons during draining operations
- Bimaterial ergonomic grip
- Steel body, Chrome plated finish

L mm	code	
270	U02631147	1



## 3/8

## 263 F

### Drain plug socket with female square

- 3/8" square drive

□ mm	Ø mm	L mm	code	
10	17,6	29,5	U02631102	1



## 3/8

## 263 Q

### Drain plug socket with male square

- 3/8" square drive

□ mm	L mm	code	
8	29,5	U02631114	1
10,5	29,5	U02631116	1



## 3/8

## 263 XZN

### Drain plug socket with XZN male

- 3/8" square drive
- AUDI gearbox

XZN	L mm	code	
M16	55	U02631145	1



## 3/8

## 263 VAG

### Drain plug socket for Audi and Volkswagen

- 3/8" square drive
- For unscrewing and removing the new oil plugs in plastic mounted on all new cars Audi and Volkswagen
- Can be used on the following car models: Audi A1, A3, A4, A5, A6, A7, Q3, Q5, Q7, TT, TTS Seat Alhambra, Leon, Toledo Skoda Octavia, Rapid, Superb, Yeti Volkswagen Maggolino, Caddy, CC, Golf, Jetta, Passat, Polo, Scirocco, Sharan, Tiguan, Touran

L mm	code	
34	U02631150	1



## 264/1

### Drain plug wrench

- CITROEN, RENAULT, PEUGEOT

□ mm	L mm	code	
8x10	230	U02640011	1



## 270 BM

### Impact socket wrench for Mercedes wheel nuts

- Indispensable for loosening and tightening the new profile of the Mercedes screws
- Teflon protection to reduce the risk to damage alloy rims
- Suitable for models: C and GLK-Class (W204) E-Class (W211, W212, W207) SLK-Class (W172) ML-Class (W164, W166) CL-Class (W216) S-Class (W221, W222)

a mm	L mm	code	
44	80	U02700140	1





1/2

## 270 C

### Impact sockets for tyre rims with teflon protection

- Teflon protection that reduces the risk of damage to the alloy rims
- Employ safety pin 235 MCA/4 (U02350204Q) for the size 15 and 235 MCA/6 (U02350206Q) for the sizes from 17 to 27
- Employ locking ring 235 MDA/4 (U02350224Q) for the size 15 and 235 MDA/6 (U02350226Q) for the sizes from 17 to 27

Ø mm	a mm	L mm	code	
15	24	85	U02700315	1
17	26,5	85	U02700417	1
19	28,5	85	U02700419	1
21	30,5	85	U02700421	1
22	33	85	U02700322	1
24	34,5	85	U02700324	1
27	38,5	85	U02700327	1



## 270 CP

### Spare teflon protection

Ø mm	code	
15	U02700215Q	1
17	U02700217Q	1
19	U02700219Q	1
21	U02700221Q	1
22	U02700222Q	1
24	U02700224Q	1
27	U02700227Q	1



1/2

## 270 C/C3

### Assortment with hexagonal impact sockets for tyre rims with teflon protection in modular box (3 pcs.)

- Teflon protection that reduces the risk of damage to the alloy rims
- Compact plastic box
- Metal closing clip
- Empty box code: U02700106Q

pcs	description	item/size
3	Impact sockets for tyre rims with teflon protection/17-19-21	270 C

LxPxH mm	code	
190x144x58	U02700106	1



1/2

## 270 C/C5

### Assortment with hexagonal impact sockets for tyre rims with teflon protection in ABS case (5 pcs.)

- Teflon protection that reduces the risk of damage to the alloy rims
- High resistance ABS case with quick closing system
- The inside tray is studied to be stored in USAG roller cabinet drawers
- Empty inner foam module: code U05191035Q

pcs	description	item/size
5	Impact sockets for tyre rims with teflon protection/15-17-19-21-22	270 C
1	Empty ABS case - size S	606 S

LxPxH mm	code	
210x130x60	U02700110	1



3/4

## 271 M

### Hub-nut socket

- 3/4" square drive

Ø mm	a mm	L mm	code	
36	46	36	U02712005	1



3/4

## 271 ML

### Impact sockets for hub-nuts

- FIAT - LANCIA - ALFA ROMEO
- 3/4" square drive
- Employ safety pin 235 MCA/8 (U02350207Q)
- Employ locking ring 235 MDA/8 (U02350227Q)

Ø mm	a mm	L mm	code	
36	46,8	100	U02712006	1



## 272

ISO 691 ISO 1174-1

### Cross-type wheel nut wrenches (cars and light industrial vehicles)

- 1/2" interchangeable square male
- Dimensions: 400x400 mm

n°	Ø mm	a mm	code	
3	17x19x22x1/2"	25x28x32	U02720000	1
5	17x19x21x1/2"	25x28x30	U02720103	1



## 272 CA

ISO 691 ISO 1174-1

### Cross-type wheel nut wrenches (industrial vehicles)

- 3/4" interchangeable square male
- Dimensions: 700x700 mm

n°	Ø mm	a mm	code	
1	24x27x30x3/2"	35x39x42x45	U02720202	1
3	24x27x32x3/4"	36x39x46	U02720201	1



1/2

## 272 Q 1/2"

### Spare square male

- For cross-type wheel nut wrenches 272/3 and 272/5

à gr	code	
40	U02720202Q	1

3/4

## 272 Q 3/4"

### Spare square male

- For cross-type wheel nut wrenches 272 CA 3

à gr	code	
50	U02720302Q	1

## TUTORIAL VIDEO



YouTube



## 272 DS

### Kit to extract nuts and screws from alloy wheels (10 pcs.)

- Suitable for all types of locking wheel nuts and screws with different profiles and shapes (standard and with rotating ring)
- Can also be used on standard nuts and screws
- Does not damage the alloy rim
- Special tungsten carbide drills capable of drilling any type of material (lubricate with cutting oil at each use)
- Super thin conical sockets to center/extract on any type of alloy wheel
- Conical sockets outside diameter: Ø30 - Ø26 - Ø24 mm
- Extractor with hexagonal drive tested to withstand over 150 Nm (even beyond the tightening torques declared by the car manufacturers)

pcs	description	item/size
1	Impact sockets for tyre rims with teflon protection	270 C/17
3	Conical sockets to center/extract (3 pcs.) /19-21,8-25	272 CS
2	Extractors with hexagonal drive (2 pcs.)	272 EX
2	Special tungsten carbide tips (2 pcs.)	272 P/8,7
2	Kit with special handle and socket for removing the extractor	272 PH
1	Empty ABS case - size M	606 M

LxPxH mm	code	item/size
330x215x60	U02720001	1



## 272 CS

### Conical sockets to center/extract (3 pcs.)

- They provide an excellent grip on the head of the locking nuts and screws
- To be used as a centering socket in case of drilling the head of the locking nut or screw
- 17 mm hexagonal drive
- Conical sockets inside diameter: Ø 19 mm - 21,8 mm - 25 mm
- Phosphated finishing

code	item/size
U02720003	1

## 272 EX

### Extractors with hexagonal drive (2 pcs.)

- To be inserted on the head of the locking nuts and screw with swivel ring after drilling with bits 272 P
- Extractors with hexagonal connection tested to withstand over 150 Nm (well beyond the tightening torques declared by the manufacturers locking nuts or screws)

L mm	code	item/size
75	U02720004	1

## 272 P

### Special tungsten carbide tips (2 pcs.)

- Diameter Ø 8,7 mm
- Clockwise rotation
- Adjustable stop ring for millimeter precise drilling depth
- To be used only with a drill without impact
- Do not exceed 750 rpm to safeguard the tip life
- During use, it is recommended to refrigerate with cutting oil

Ø mm	L mm	code	item/size
8,7	121	U02720002	1

## 272 PH

### Kit with special handle and socket for removing the extractor

- 272 PH1: Special beating handle to be used to insert the conical sockets 272 CS and extractor 272 EX on the head of the locking nut or screw
- 272 PH2: Special puller to be used to remove 272 EX extractor from the locking nuts or screws

code	item/size
U02720006	1

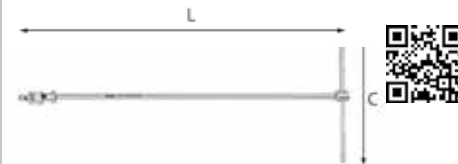

## 273 C

UNI 6754

### T-handle keys with jointed hexagonal socket bit

- Universal joint model with friction-spring to allow presetting of the socket bit at the desired angle
- Removable sliding bar
- Special Silicon Chrome Vanadium steel
- Chrome plated finish

Ø mm	c mm	L mm	code	item/size
3	165	393	U02730303	1
4	165	393	U02730304	1
5	165	393	U02730305	1
6	175	430	U02730306	1
8	175	430	U02730308	1
10	175	432	U02730310	1

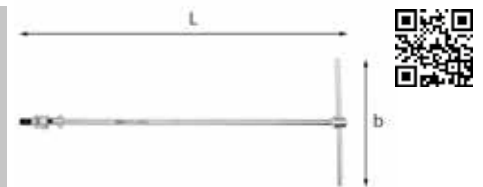

## 273 CTX

### T-handle keys with jointed socket bit for TORX® screws

- Universal joint model with friction-spring to allow presetting of the socket bit at the desired angle
- Removable sliding bar
- Special Silicon Chrome Vanadium steel
- Chrome plated finish with burnished tip

n°	b mm	L mm	code	item/size
T20	165	403	U02730053	1
T25	165	403	U02730054	1
T27	165	403	U02730055	1
T30	175	436	U02730056	1
T40	175	436	U02730057	1
T45	175	436	U02730058	1
T50	175	468	U02730059	1
T55	180	500	U02730060	1



## 273 CTX/SE8

### Set of 8 TORX® keys

pcs	description	item/size
8	T-handle keys with jointed socket bit for TORX® screws /T20-T25-T27-T30-T40-T45-T50-T55	273 CTX

kg	code	item/size
2,3	U02730065	1

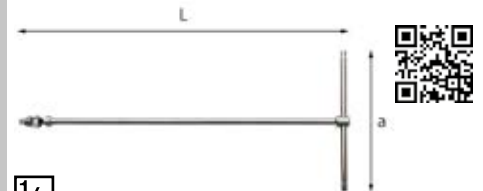

1/4

## 273 1/4" Q

ISO 1174-1

### T-handle key with jointed square drive

- Universal joint model with friction-spring to allow presetting of socket at the desired angle
- Removable sliding bar
- Special Chrome Vanadium steel
- Chrome plated finish

L mm	a mm	code	item/size
390	165	U02730201	1

3/8

## 273 3/8" Q



ISO 1174-1

## T-handle key with jointed square drive

- Universal joint model with friction-spring to allow presetting of socket at the desired angle
- Removable sliding bar
- Special Chrome Vanadium steel
- Chrome plated finish

L mm	a mm	code	
460	175	U02730202	1

1/2

## 273 1/2" Q



ISO 1174-1

## T-handle key with jointed square drive

- Universal joint model with friction-spring to allow presetting of socket at the desired angle
- Removable sliding bar
- Special Chrome Vanadium steel
- Chrome plated finish

L mm	a mm	code	
500	180	U02730203	1

1/2

## 273 1/2" Q/SE9



## T-handle key with jointed hexagonal socket bit and 8 hexagonal sockets

## Hexagonal sockets 235 1/2 EN

- 8-10-11-12-13-14-17-19 mm
- Special Chrome Molybdenum steel
- Chrome plated finish

## T-handle key with jointed square drive 273 1/2 Q

- Universal joint model with friction-spring to allow presetting of socket at the desired angle
- Removable sliding bar
- Special Chrome Vanadium steel
- Chrome plated finish

pcs	description	item/size
8	Hexagonal sockets / 8-10-11-12-13-14-17-19	235 1/2 EN
1	T-handle key with jointed square drive	273 1/2 Q

kg	code	
1,2	U02730205	1

1/2

## 273 1/2" Q NTX/S7

## T-handle key with jointed square drive and 7 TORX® female sockets

## Sockets for TORX® screws 235 1/2 NTX

- E10-E12-E14-E16-E18-E20-E24
- Special Chrome Molybdenum steel
- Chrome plated finish

## T-handle with jointed square drive 273 1/2 Q

- Universal joint model with friction-spring to allow presetting of socket at the desired angle
- Removable sliding bar
- Special Chrome Vanadium steel
- Chrome plated finish

pcs	description	item/size
7	TORX® sockets /E10-E12-E14-E16-E18-E20-E24	235 1/2 NTX
1	T-handle key with jointed square drive	273 1/2 Q

code	
U02730206	1

1/2

## 273 1/2" Q NTX/S9

## T-handle key with jointed square drive and 9 TORX® male sockets

## Sockets bits for TORX® screws 233 1/2 NTX

- T20-T25-T27-T30-T40-T45-T50-T55-T60
- Special Chrome Molybdenum steel
- Chrome plated finish

## T-handle key with jointed square drive 273 1/2 Q

- Universal joint model with friction-spring to allow presetting of socket at the desired angle
- Removable sliding bar
- Special Chrome Vanadium steel
- Chrome plated finish

pcs	description	item/size
9	Socket bits for TORX® screws /T20-T25-T27-T30-T40-T45-T50-T55-T60	233 1/2 NTX
1	T-handle key with jointed square drive	273 1/2 Q

kg	code	
1,5	U02730207	1

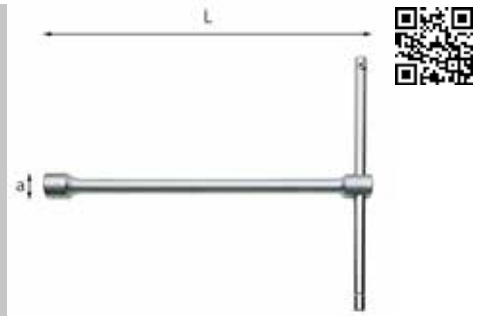

## 275

UNI 6742 DIN 3112 ISO 691

## T-handle wrenches with hexagonal opening

- Removable sliding bar

Ø mm	a mm	L mm	code	
6	9,8	215	U02750001	1
7	11,3	215	U02750002	1
8	12,5	235	U02750003	1
9	13,7	235	U02750004	1
10	15	260	U02750005	1
11	16,5	260	U02750006	1
12	17,5	260	U02750007	1
13	19,2	260	U02750008	1
14	20,5	260	U02750009	1
15	21,7	285	U02750010	1
17	24	285	U02750012	1
18	25,2	285	U02750013	1
19	26,5	310	U02750014	1
21	29	310	U02750016	1
22	30,2	310	U02750017	1
24	33	315	U02750019	1
27	37	315	U02750022	1
30	40,5	320	U02750025	1

## 275 SE5

## Set of 5 T-handle wrenches with hexagonal opening

pcs	description	item/size
5	T-handle wrenches with hexagonal opening /8-10-13-17-19	275

kg	code	
2	U02750180	1

## 275 SE12

## Set of 12 T-handle wrenches with hexagonal opening

pcs	description	item/size
12	T-handle wrenches with hexagonal opening /8-9-10-11-12-13-14-15-17-18-19-22	275

kg	code	
6	U02750185	1



YouTube



PAGE  
**106**

## 280 T

The reference for professionals

- “T” design
- Three ends of the same size
- Chrome Vanadium steel



SAME BLADE AS  
THE 280 T KEYS

PAGE  
**104**

## 280 HG

Excellent ergonomics

- “L” design with bimaterial handgrip
- Two ends of the same size
- Silicon carbide steel

























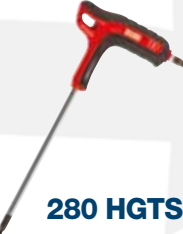





PAGE  
**101**

## 280

For all uses

- “L” design
- Two ends of the same size
- Chrome Vanadium steel

	HEXAGONAL			TORX®		XZN
		 			 	
<b>280 T</b>	 <b>280 T</b>  <b>280 TK</b>	 <b>280 TTS</b>		 <b>280 TTX</b>	 <b>280 TSTX</b>	
<b>280 HG - HA</b>	 <b>280 HG</b>	 <b>280 HGTS</b>	 <b>280 HAP</b>	 <b>280 HATX</b>		
<b>280</b>	 <b>280</b>  <b>280 N</b>  <b>280 L</b>	 <b>280 LTS</b>  <b>280 XLTS</b>	 <b>280 P</b>  <b>280 LTSP</b>	 <b>280 TX</b>  <b>280 STX</b>	 <b>280 LTSTX</b>	 <b>280 XZN</b>



## 276 CE

UNI 6743 ISO 691

### T-handle wrenches with jointed hexagonal socket

- Universal joint model with friction-spring to allow presetting of the socket at the desired angle
- Removable sliding bar

Ø mm	a mm	L mm	code	
6	9,5	398	U02760400	1
7	10,7	398	U02760401	1
8	12	398	U02760402	1
9	13,2	398	U02760403	1
10	14,6	431	U02760404	1
11	15,8	431	U02760405	1
12	17	434	U02760406	1
13	18,7	466	U02760407	1
14	20,7	466	U02760408	1
15	20,9	497	U02760409	1
16	22,2	499	U02760410	1
17	23,4	499	U02760411	1
18	24,7	501	U02760412	1
19	26	523	U02760413	1
20	27,3	526	U02760414	1
21	28,5	526	U02760415	1
22	29,7	526	U02760416	1
24	32,5	531	U02760417	1



## D 276 CE

UNI 6743 ISO 691

### T-handle wrenches with jointed hexagonal socket

Ø mm	a mm	L mm	code	
7	10,7	398	U02760401D	1
8	12	398	U02760402D	1
10	14,6	431	U02760404D	1
13	18,7	466	U02760407D	1
14	20,7	466	U02760408D	1
16	22,2	499	U02760410D	1
17	23,4	499	U02760411D	1



## 276 CE/SE5

### Set of 5 T-handle wrenches with jointed hexagonal socket

pcs	description	item/size
5	T-handle wrenches with jointed hexagonal socket /8-10-13-17-19	276 CE

kg	code	
2,5	U02760483	1

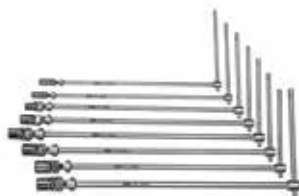

## 276 CE/SE8

### Set of 8 T-handle wrenches with jointed hexagonal socket

pcs	description	item/size
8	T-handle wrenches with jointed hexagonal socket /7-8-10-12-13-14-17-19	276 CE

kg	code	
3,5	U02760484	1

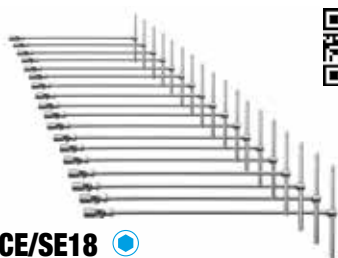

## 276 CE/SE18

### Set of 18 T-handle wrenches with jointed hexagonal socket

pcs	description	item/size
18	T-handle wrenches with jointed hexagonal socket /6-7-8-9-10-11-12-13-14-15-16-17-18-19-20-21-22-24	276 CE

kg	code	
9,5	U02760481	1



## 276 CEB

UNI 6743 ISO 691

### T-handle wrenches with jointed hexagonal socket and retaining system

- Universal joint model with friction-spring to allow presetting of the socket at the desired angle
- Removable sliding bar

Ø mm	a mm	L mm	code	
8	12	398	U02760471	1
10	14,6	431	U02760472	1
13	18,7	466	U02760473	1
17	23,4	499	U02760474	1
19	26	523	U02760475	1



## 276 CEB/SE5

### Set of 5 T-handle wrenches with jointed hexagonal socket and retaining system

pcs	description	item/size
5	T-handle wrenches with jointed hexagonal socket and retaining system /8-10-13-17-19	276 CEB

kg	code	
2,5	U02760490	1

## 276 CEBM



### Spare springs

- For T-handle wrenches with jointed hexagonal socket and retaining system 276 CEB

Ø mm	code	
8	U02760471Q	1
10	U02760472Q	1
13	U02760473Q	1
17	U02760474Q	1
19	U02760475Q	1



## 276 CTX

### T-handle wrenches with jointed TORX® socket

- Universal joint model with friction-spring to allow presetting of the socket at the desired angle
- Removable sliding bar

Ø mm	a mm	L mm	code	
E6	8	399	U02760021	1
E7	8,5	399	U02760022	1
E8	10	399	U02760023	1
E10	13	432	U02760024	1
E12	15	432	U02760025	1
E14	17	499	U02760026	1
E16	19	499	U02760027	1
E18	20,5	499	U02760028	1
E20	23,5	523	U02760029	1

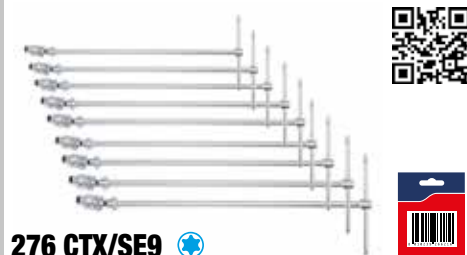

## 276 CTX/SE9

### Set of 9 T-handle wrenches with jointed TORX® sockets

pcs	description	item/size
9	T-handle wrenches with jointed TORX® socket / E6-E7-E8-E10-E12-E14-E16-E18-E20	276 CTX

kg	code	
3,9	U02760030	1

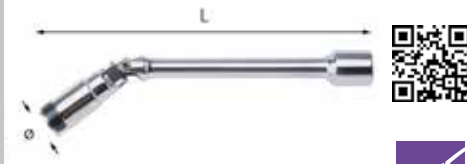

3/8"

## 278 D

ISO 11168

### Glowplug wrenches with jointed socket

- Block system for retaining the glowplug
- Hexagonal opening
- 3/8" square drive

Ø mm	Ø mm	L mm	code	
8L	14,5	178	U02780017	1
9L	14,5	178	U02780016	1
10L	14,5	178	U02780019	1
12L	17	178	U02780021	1

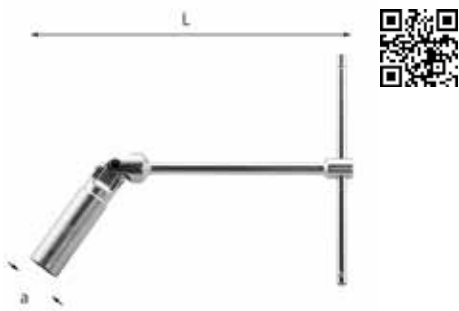

## 278 N

ISO 11168

### T-handle spark plug wrenches with jointed socket

- Hexagonal opening
- Rubber gasket for retaining the spark plug
- Removable sliding bar

Ø mm	a mm	L mm	code	
16	22	270	U02780011	1
18	25	270	U02780013	1
19	25	270	U02780014	1
20,8	26	270	U02780015	1



## D 278 N

ISO 11168

### T-handle spark plug wrenches with jointed socket

Ø mm	a mm	L mm	code	
16	22	270	U02780011D	1
18	25	270	U02780013D	1
19	25	270	U02780014D	1

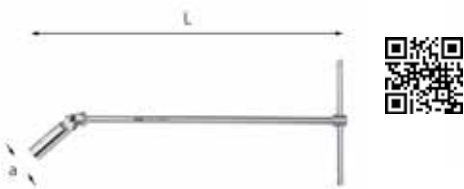

## 278 NL

ISO 11168

### Long T-handle spark plug wrenches with jointed socket

- Hexagonal opening
- Rubber gasket for retaining the spark plug
- Removable sliding bar

Ø mm	a mm	L mm	code	
16	22	517	U02780031	1
20,8	27,5	564	U02780035	1



## 278 NL/SE2

### Set of 2 long T-handle spark plug wrenches

pcs	description	item/size
2	Long T-handle spark plug wrenches with jointed socket /16-20,8	278 NL

code	
U02780036	1



## 278 A

### Spare gasket

- For T-handle spark plug wrenches 278 N - 278 NL - 279 3/8" - 279 N

Ø mm	code	
14-16	U02780001Q	10
18	U02780002Q	10
19	U02780003Q	10
20,8	U02780004Q	10



## 279 3/8"

### Spark plug sockets

- Bihexagonal opening for size 14 mm
- Hexagonal opening for size 16 mm
- Rubber gasket for retaining the spark plug
- 3/8" square drive

Ø mm	L mm	Ø mm	code	
14	90	19	U02791011	1
14L	250	19	U02791012	1
16	90	21,5	U02791013	1
16L	250	21,5	U02791014	1



## 279 N 1/2"

ISO 11168

### Spark plug sockets

- Hexagonal opening
- Rubber gasket for retaining the spark plug
- 1/2" square drive

Ø mm	Ø mm	L mm	code	
16	22	90	U02792013	1
16L	21,5	250	U02792014	1
18	25	90	U02792016	1
20,8	28	90	U02792021	1



## 279 PC

### Pliers for spark plug caps

- For disconnecting caps of spark plugs
- No damage to leads

Ø mm	L mm	code	
11	198	U02796004	1

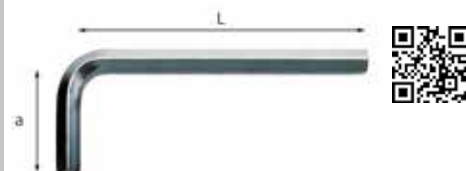

## 280

ISO 2936

### Angled hexagon keys

- For hex socket screws
- Special Chrome Vanadium steel
- Zinc Chrome plated finish

Ø mm	a mm	L mm	code	
1,5	14	45	U02800000	20
2	16	50	U02800001	20
2,5	18	56	U02806002	20
3	20	63	U02806003	20
3,5	22	66	U02800004	20
4	25	70	U02806005	20
4,5	26	75	U02800006	20
5	28	80	U02806007	20
6	32	90	U02806008	20
7	34	95	U02800009	10
8	36	100	U02806010	10
9	38	105	U02800011	10
10	40	112	U02800012	10
11	42	118	U02800024	10
12	45	125	U02800013	10
13	50	132	U02800023	1
14	56	140	U02800014	1
17	63	160	U02800015	1
19	70	180	U02800016	1
22	80	200	U02800017	1
24	90	224	U02800018	1
27	100	250	U02800019	1
30	112	280	U02806020	1
32	125	315	U02800021	1
36	140	355	U02800022	1

## 280 P

### Angled hexagon keys, inch sizes

- For hex socket screws
- Special Chrome Vanadium steel
- Zinc Chrome plated finish



⌀ "	a mm	L mm	code	
1/20	13	41	U02800101	20
1/16	14	45	U02800102	20
5/64	16	50	U02800103	20
3/32	18	56	U02800104	20
1/8	20	63	U02800105	20
5/32	25	70	U02800106	20
3/16	28	80	U02800107	20
7/32	30	85	U02800108	20
1/4	32	90	U02800109	20
5/16	36	100	U02800110	5
3/8	38	105	U02800111	5
7/16	42	118	U02800112	5
1/2	50	132	U02800113	5

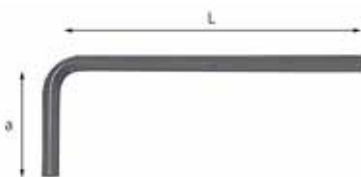

## 280 N

### Angled hexagon keys

- For hex socket screws
- Special Chrome Vanadium steel
- Burnished finish

ISO 2936

⌀ mm	a mm	L mm	code	
1,5	14	45	U02800701	20
2	16	50	U02800702	20
2,5	18	56	U02800703	20
3	20	63	U02800704	20
3,5	22	66	U02800705	20
4	25	70	U02800706	20
4,5	26	75	U02800707	20
5	28	80	U02800708	20
6	32	90	U02800709	10
7	34	95	U02800710	10
8	36	100	U02800711	10
9	38	105	U02800712	10
10	40	112	U02800713	10
11	42	118	U02800714	10
12	45	125	U02800715	10



## 280 S7

### Set of 7 angled hexagon keys

- For hex socket screws
- Special Chrome Vanadium steel
- Zinc Chrome plated finish
- Supplied in plastic holder

pcs description	item/size
7 Angled hexagon keys /2-2,5-3-4-4,5-5-6	280

⌘ gr	code	
95	U02800280	1

## 280 S9

### Set of 9 angled hexagon keys

- For hex socket screws
- Zinc Chrome plated finish
- Supplied with plastic holder
- Special Chrome Vanadium steel

pcs description	item/size
9 Angled hexagon keys /1,5-2-2,5-3-4-5-6-8-10	280
1 Empty plastic holder	280 LTS/SV9

⌘ gr	code	
250	U02800287	1



## 280 N/S9

### Set of 9 angled hexagon keys

- For hex socket screws
- Special Chrome Vanadium steel
- Burnished finish
- Supplied with plastic holder

pcs description	item/size
9 Angled hexagon keys /1,5-2-2,5-3-4-5-6-8-10	280 N
1 Empty plastic holder	280 LTS/SV9

⌘ gr	code	
250	U02800731	1



## 280 P/S8

### Set of 8 angled hexagon keys, inch sizes

- For hex socket screws
- Zinc Chrome plated finish
- Supplied with plastic holder
- Special Chrome Vanadium steel

pcs description	item/size
8 Angled hexagon keys, inch sizes / 3/32-1/8-5/32-3/16-7/32-1/4-5/16-3/8	280 P
1 Empty plastic holder	280 P/SV8

⌘ gr	code	
250	U02800288	1

## 280 P/SV8

### Empty plastic holder

- For angled hexagon keys 280 P/S8 - 280 LTSP/S8

code	
U02800002Q	1



## 280 SE8

### Set of 8 angled hexagon keys

- For hex socket screws
- Zinc Chrome plated finish
- Special Chrome Vanadium steel
- Supplied in plastic pouch

pcs description	item/size
8 Angled hexagon keys /1,5-2-2,5-3-3,5-4-5-6	280
1 Empty pouch	280 NV1

⌘ gr	code	
95	U02800283	1

## 280 P/SE8

### Set of 8 angled hexagon keys, inch sizes

- For hex socket screws
- Special Chrome Vanadium steel
- Zinc Chrome plated finish
- Supplied in plastic pouch

pcs description	item/size
8 Angled hexagon keys, inch sizes / 1/16-5/64-3/32-1/8-5/32-3/16-7/32-1/4	280 NV1
1 Empty pouch	

⌘ gr	code	
95	U02800383	1



## 280 NV1

### Empty pouch

- For angled hexagon keys 280 P/SE8, 280 SE8

code	
U02800206	1





## 280 SE12

### Set of 12 angled hexagon keys

- For hex socket screws
- Zinc Chrome plated finish
- Special Chrome Vanadium steel
- Supplied in plastic pouch

pcs	description	item/size
12	Angled hexagon keys /2-2,5-3-3,5-4-4,5-5-6-7-8-9-10	280 NV
1	Empty pouch	280 NV

gr	code	img
400	U02800284	

## 280 P/SE12

### Set of 12 angled hexagon keys, inch sizes

- For hex socket screws
- Special Chrome Vanadium steel
- Zinc Chrome plated finish
- Supplied in plastic pouch

pcs	description	item/size
12	Angled hexagon keys, inch sizes /1/20-1/16-5/64-3/32-1/8-5/32-3/16-7/32-1/4-5/16-3/8-7/16	280 P
1	Empty pouch	280 NV

gr	code	img
400	U02800285	



## 280 N/SE12

### Set of 12 angled hexagon keys

- For hex socket screws
- Special Chrome Vanadium steel
- Zinc Chrome plated finish
- Supplied in plastic pouch

pcs	description	item/size
12	Angled hexagon keys /2-2,5-3-3,5-4-4,5-5-6-7-8-9-10	280
1	Empty pouch	280 NV

gr	code	img
400	U02800733	



## 280 NV

### Empty pouch

- For angled hexagon keys 280 N/SE12, 280 P/SE12, 280 SE12

code	img
U02800208	



## 280 MP/S24

### Set of 24 angled hexagon keys

- For hex socket screws
- Special Chrome Vanadium steel
- Zinc Chrome plated finish
- Supplied in plastic pouch

pcs	description	item/size
12	Angled hexagon keys /2-2,5-3-3,5-4-4,5-5-6-7-8-9-10	280
12	Angled hexagon keys, inch sizes /1/20-1/16-5/64-3/32-1/8-5/32-3/16-7/32-1/4-5/16-3/8-7/16	280 P

gr	code	img
880	U02800481	



## 280 S8

### Set of 8 hexagon keys

- Burnished finish
- Supplied with pocket holder in steel covered with shock resistant plastic

pcs	description	item/size
8	Angled hexagon keys /1,5-2-2,5-3-4-5-6-8	280

gr	code	img
220	U02800192	

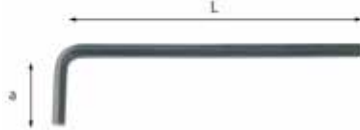

## 280 L

### Long angled hexagon keys

- For hex socket screws
- Special Chrome Vanadium steel
- Burnished finish

mm	a mm	L mm	code	img
1,5	13	88	U02800039	<a href="#">20</a>
2	15	98	U02800040	<a href="#">20</a>
2,5	17	112	U02800041	<a href="#">20</a>
3	20	122	U02800042	<a href="#">20</a>
3,5	22	131	U02800043	<a href="#">20</a>
4	25	141	U02800044	<a href="#">20</a>
4,5	26	150	U02800045	<a href="#">20</a>
5	28	160	U02800046	<a href="#">20</a>
6	32	174	U02800047	<a href="#">20</a>
7	34	185	U02800048	<a href="#">10</a>
8	36	197	U02800049	<a href="#">10</a>
9	38	210	U02800050	<a href="#">10</a>
10	40	224	U02800051	<a href="#">10</a>
12	45	238	U02800052	<a href="#">10</a>

ISO 2936



## 280 L/S9

### Set of 9 long angled hexagon keys

- For hex socket screws
- Special Chrome Vanadium steel
- Burnished finish
- Supplied with plastic holder

pcs	description	item/size
9	Long angled hexagon keys /1,5-2-2,5-3-4-5-6-8-10	280 L
1	Empty plastic holder	280 LTS/SV9

gr	code	img
405	U02800057	

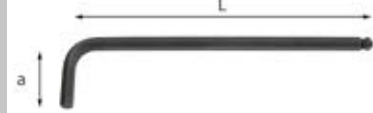

## 280 LTS

ISO 2936

### Long angled hexagon keys with spherical head

- For hex socket screws
- Model giving a working angle of up to 25° with respect to the axis of the screw
- Special Chrome Vanadium steel
- Burnished finish

mm	a mm	L mm	code	img
1,5	14	62	U02800059	<a href="#">10</a>
2	16	75	U02800060	<a href="#">10</a>
2,5	18	85	U02800061	<a href="#">10</a>
3	20	90	U02800062	<a href="#">10</a>
4	25	100	U02800064	<a href="#">10</a>
5	28	115	U02800066	<a href="#">10</a>
6	32	135	U02800067	<a href="#">10</a>
8	36	150	U02800069	<a href="#">10</a>
10	40	170	U02800071	<a href="#">10</a>



## 280 LTSP

### Long angled hexagon keys with spherical head, - inch sizes

- For hex socket screws
- Model giving a working angle of up to 25° with respect to the axis of the screw
- Special Chrome Vanadium steel
- Burnished finish

"	a mm	L mm	code	img
1/16	14	62,5	U02800091	<a href="#">5</a>
5/64	13,5	75	U02800092	<a href="#">5</a>
3/32	17,5	84,5	U02800093	<a href="#">5</a>
1/8	20	90	U02800094	<a href="#">5</a>
5/32	25	100	U02800095	<a href="#">5</a>
3/16	27	117	U02800096	<a href="#">5</a>
7/32	30,5	135,5	U02800097	<a href="#">5</a>
1/4	33	141,5	U02800098	<a href="#">5</a>
5/16	36	150	U02800099	<a href="#">5</a>
3/8	37,5	170,5	U02800100	<a href="#">5</a>



## 280 LTS/S9

### Set of 9 long angled hexagon keys with spherical head

- For hex socket screws
- Model giving a working angle of up to 25° with respect to the axis of the screw
- Special Chrome Vanadium steel
- Burnished finish
- Supplied with plastic holder

pcs	description	item/size
9	Long angled hexagon keys with spherical head /1,5-2-2,5-3-4-5-6-8-10	280 LTS
1	Empty plastic holder	280 LTS/SV9

gr	code	
350	U02800084	1



## 280 LTS/SV9

### Empty plastic holder

- For angled hexagon keys 280 S9 - 280 N/S9 - 280 L/S9 - 280 LTS/S9 - 280 XLTS/S9

gr	code	
30	U02800001Q	1



## 280 LTSP/S8

### Set of 8 long angled hexagon keys with spherical head, inch sizes

- For hex socket screws
- Model giving a working angle of up to 25° with respect to the axis of the screw
- Special Chrome Vanadium steel
- Burnished finish
- Supplied with plastic holder

pcs	description	item/size
8	Long angled hexagon keys with spherical head, - inch sizes /3/32-1/8-5/32-3/16-7/32-1/4-5/16-3/8"	280 LTSP
1	Empty plastic holder	280 P/SV8

gr	code	
320	U02800090	1



## 280 P/SV8

### Empty plastic holder

- For angled hexagon keys 280 P/S8 - 280 LTSP/S8

code	
U02800002Q	1



## 280 LTSI/S9

by FAGOM

### Set of 9 long angled hexagon keys with spherical head in stainless steel

- 280 LTS/1,5-2-2,5-3-4-5-6-8-10 mm
- For hex socket screws
- Model giving a working angle of up to 25° with respect to the axis of the screw
- Stainless steel
- Supplied with plastic holder

gr	code	
350	U02800185	1



## 280 D

UNI 10753

### Screwdrivers for hexagon socket screws with handgrip

- For hex socket screws
- Ergonomic three-material grip with soft covering, resistant to oils and chemicals
- Special Chrome Vanadium steel blade
- Burnished finish

mm	a mm	L mm	handle size	code	
1,5	75	169	M0	U02800821	5
2	75	169	M0	U02800822	5
2,5	75	169	M0	U02800823	5
3	75	169	M0	U02800824	5
4	75	178	M1	U02800826	1
5	100	209	M2	U02800828	1
6	100	220	M3	U02800830	1



## 280 TS

### Screwdrivers with spherical head and handgrip

- For hex socket screws
- Model with spherical head giving a working angle of up to 25° with respect to the axis of the screw
- Ergonomic three-material grip with soft covering, resistant to oils and chemicals
- Special Chrome Vanadium steel blade
- Burnished finish

mm	a mm	L mm	handle size	code	
2	75	170	M0	U02800859	5
2,5	75	170	M0	U02800860	5
3	75	170	M0	U02800861	5
4	75	170	M1	U02800863	5
5	100	210	M2	U02800865	5
6	100	220	M3	U02800867	5

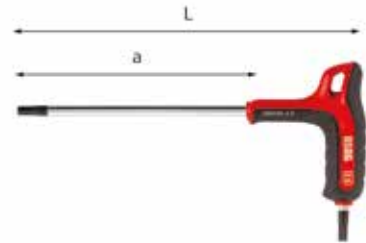

## 280 HG

ISO 2936

### Angled hexagon keys with bimaterial handgrip

- For hex socket screws
- Ergonomic bimaterial handgrip with anti-slip coating
- Design studied for a safe grip during operations
- Special Chrome Vanadium steel
- Chrome plated finish with burnished tips to ensure precision and perfect fit with the screw
- Burnished tips up to size 8 mm, chromed tips for size 10 mm

mm	a mm	L mm	code	
2	90	133	U02801390	2
2,5	90	133	U02801391	2
3	90	133	U02801392	2
3,5	90	133	U02801393	2
4	90	133	U02801394	2
4,5	90	133	U02801395	2
5	90	133	U02801396	2
6	90	133	U02801398	2
7	90	133	U02801399	2
8	90	133	U02801400	2
10	90	133	U02801402	2



## D 280 HG

### Angled hexagon keys with bimaterial handgrip

mm	a mm	L mm	code	
2	90	133	U02801390D	1
2,5	90	133	U02801391D	1
3	90	133	U02801392D	1

## D 280 HG

● mm	a mm	L mm	code	
3,5	90	133	U02801393D	1
4	90	133	U02801394D	1
4,5	90	133	U02801395D	1
5	90	133	U02801396D	1
6	90	133	U02801398D	1
7	90	133	U02801399D	1
8	90	133	U02801400D	1
10	90	133	U02801402D	1



### 280 HG/SE6

#### Set of 6 angled hexagon keys with bimaterial handgrip

pcs description	item/size
6 Angled hexagon keys with bimaterial handgrip/2,5-3-4-5-6-8	280 HG

▲ gr	code	
500	U02801460	1



### 280 HG/SE11

#### Set of 11 angled hexagon keys with bimaterial handgrip

pcs description	item/size
11 Angled hexagon keys with bimaterial handgrip/2-2,5-3-3,5-4-4,5-5-6-7-8-10	280 HG

▲ gr	code	
805	U02801461	1

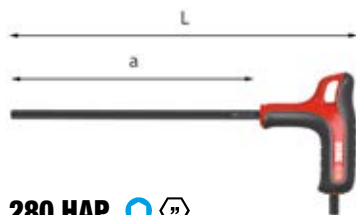

### 280 HAP

#### Angled hexagon keys with handgrip, inch sizes

- For hex socket screws
- Ergonomic bimaterial handgrip with anti-slip coating
- Design studied for a safe grip during operations
- Special Silicon carbide steel blade
- Burnished finish

●"	a mm	L mm	code	
1/4	175	240	U02800403	2
7/32	175	240	U02800404	2
5/32	130	183	U02800405	2
5/16	175	240	U02800406	2
3/8	175	240	U02800407	2
3/16	130	183	U02800408	2



### 280 HAP/SE6

#### Set of 6 angled hexagon keys with handgrip, inch sizes

pcs description	item/size
6 Angled hexagon keys with handgrip, inch sizes /1/4-7/32-5/32-5/16-3/8-3/16	280 HAP

▲ gr	code	
500	U02800462	1

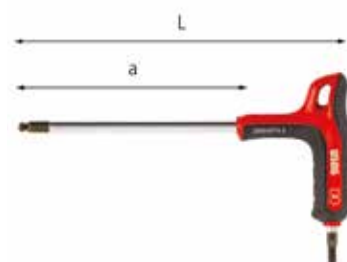

### 280 HGTS

ISO 2936

#### Angled hexagon keys with spherical head and bimaterial handgrip

- For hex socket screws
- Model giving a working angle of up to 30° with respect to the axis of the screw
- Ergonomic bimaterial handgrip with anti-slip coating
- Design studied for a safe grip during operations
- Special Chrome Vanadium steel
- Chrome plated finish with burnished tips to ensure precision and perfect fit with the screw
- Burnished tips up to size 8 mm, chromed tips for size 10 mm

● mm	a mm	L mm	code	
2,5	90	133	U02801421	2
3	90	133	U02801422	2
4	130	133	U02801424	2
5	130	133	U02801426	2
6	175	133	U02801427	2
7	175	133	U02801428	2
8	175	133	U02801429	2
10	175	133	U02801431	2

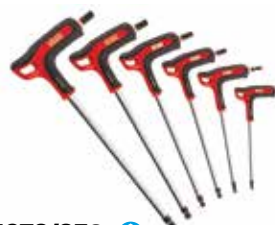

### 280 HGTS/SE6

#### Set of 6 angled hexagon keys with spherical head and bimaterial handgrip

pcs description	item/size
6 Angled hexagon keys with spherical head and bimaterial handgrip /2,5-3-4-5-6-8	280 HGTS

▲ gr	code	
670	U02801463	1

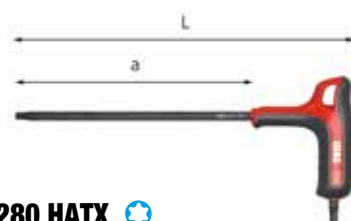

### 280 HATX

#### Angled keys with handgrip for TORX® screws

- Ergonomic bimaterial handgrip with antislip coating
- Design studied for a safe grip during operations
- Special Silicon carbide steel blade
- Burnished finish

n°	a mm	L mm	code	
T6	90	133	U02800441	2
T7	90	133	U02800442	2
T8	90	133	U02800443	2
T9	90	133	U02800444	2
T10	90	133	U02800445	2
T15	90	133	U02800446	2
T20	130	183	U02800447	2
T25	130	183	U02800448	2
T27	130	183	U02800449	2
T30	175	240	U02800450	2
T40	175	240	U02800451	2
T45	175	240	U02800452	2
T50	175	240	U02800453	2



### 280 HATX/SE6

#### Set of 6 angled keys with handgrip for TORX® screws

pcs description	item/size
6 Angled keys with handgrip for TORX® screws /T8-T10-T15-T20-T25-T30	280 HATX

▲ gr	code	
400	U02800464	1



### 280 HATX/SE13

#### Set of 13 angled keys with handgrip for TORX® screws

pcs description	item/size
13 Angled keys with handgrip for TORX® screws /T6-T7-T8-T9-T10-T15-T20-T25-T27-T30-T40-T45-T50	280 HATX

▲ Kg	code	
1	U02800465	1



## 280 T

ISO 2936

### T-handle hexagon keys

- For hex socket screws
- Special Chrome Vanadium steel
- Chrome plated finish with burnished tips up to size 8 mm to ensure precision and perfect fit with the screw

mm	a mm	L mm	gr	code	
2	62	125	22	U02800130	5
2,5	62	125	22	U02800131	1
3	75	150	26	U02800132	5
3,5	75	150	26	U02800133	1
4	90	180	63	U02800134	5
4,5	90	180	63	U02800135	5
5	105	210	100	U02800136	5
6	105	210	145	U02800137	5
7	105	210	145	U02800138	1
8	125	250	220	U02800139	5
9	140	280	345	U02800140	1
10	150	300	440	U02800141	5
12	160	320	645	U02800142	5
14	170	340	630	U02800143	5

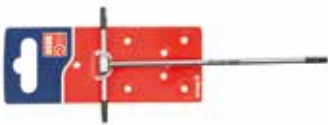

## D 280 T

ISO 2936

### T-handle hexagon keys

mm	a mm	L mm	gr	code	
2	62	125	22	U02800130D	1
2,5	62	125	22	U02800131D	1
3	75	150	26	U02800132D	1
3,5	75	150	26	U02800133D	1
4	90	180	63	U02800134D	1
4,5	90	180	63	U02800135D	1
5	105	210	100	U02800136D	1
6	105	210	145	U02800137D	1
7	105	210	145	U02800138D	1
8	125	250	220	U02800139D	1
9	140	280	345	U02800140D	1
10	150	300	440	U02800141D	1
12	160	320	645	U02800142D	1
14	170	340	630	U02800143D	1



## 280 T

T-handle hexagon key



YouTube

Fix bar

Special Silicon Chrome Vanadium steel

USAG keys

Other keys

**Guaranteed safety**

- + 30% resistance to torsion compared to ISO 2936 rules.
- When the breaking torque is reached, the key will deform without breaking.

## 280 T/SE6

### Set of 6 T-handle hexagon keys

pcs	description	item/size
6	T-handle hexagon keys / 2-2,5-3-4-5-6	280 T

gr	code	
600	U02800188	1



## 280 T/SE7

### Set of 7 T-handle hexagon keys

pcs	description	item/size
7	T-handle hexagon keys / 2-2,5-3-4-5-6-8	280 T

gr	code	
670	U02800903	1



## 280 T/SE8

### Set of 8 T-handle hexagon keys

pcs	description	item/size
8	T-handle hexagon keys / 2-2,5-3-4-5-6-8-10	280 T

Kg	code	
1	U02800186	1

## 280 T/SE14

### Set of 14 T-handle hexagon keys

pcs	description	item/size
14	T-handle hexagon keys / 2-2,5-3-3,5-4-4,5-5-6-7-8-9-10-12-14	280 T

Kg	code	
3	U02800181	1



## 280 T/S8

### Set of 8 T-handle hexagon keys

- For hex socket screws
- Special Chrome Vanadium steel
- Chrome plated finish with burnished tips up to size 8 mm to ensure precision and perfect fit with the screw
- Supplied in sheet steel stand

pcs	description	item/size
8	T-handle hexagon keys / 2-2,5-3-4-5-6-8-10	280 T

Kg	code	
1,8	U02800213	1



## 280 TSV8

Empty metal display stand

kg	code	item/size
700	U02800214Q	1



## 280 TTS

ISO 2936

T-handle hexagon keys with spherical head

- For hex socket screws
- Special Chrome Vanadium steel
- Chrome plated finish with burnished tips to ensure perfect fit with the screws
- Model with a working angle up to 30° with respect to the axis of the screw
- Spherical head for exceptional accessibility

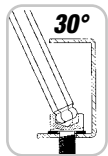

mm	a mm	L mm	kg	code	item/size
2,5	62	125	16	U02800741	1
3	75	150	20	U02800742	1
4	90	180	60	U02800744	1
5	105	210	95	U02800746	1
6	105	210	130	U02800747	1
8	125	250	200	U02800749	1



## 280 TTS/SE6

Set of 6 T-handle hexagon keys with spherical head

pcs	description	item/size
6	T-handle hexagon keys with spherical head/2,5-3-4-5-6-8	280 TTS

kg	code	item/size
570	U02800760	1

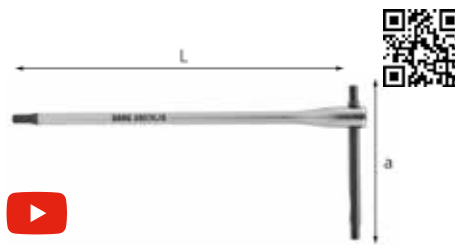

ISO 2936

## 280 TK

T-handle hexagon keys with sliding bar

- For hex socket screws
- Sliding bar for greater accessibility than the standard keys
- Safety pin to prevent the extraction of the bar
- Special Chrome Vanadium steel
- Chrome plated finish with burnished tips on the shaft
- Sliding bar fully burnished
- Tips fit perfectly with the screws

mm	a mm	L mm	kg	code	item/size
2,5	63	150	20	U02800002	1
3	63	150	22	U02800003	1
4	76	175	47	U02800005	1
5	87	195	76	U02800007	1
6	99	215	117	U02800008	1
8	122	250	219	U02800010	1



## 280 TK/SE6

Set of 6 T-handle hexagon keys with sliding bar

pcs	description	item/size
6	T-handle hexagon keys with sliding bar /2,5-3-4-5-6-8	280 TK

kg	code	item/size
660	U02800020	1

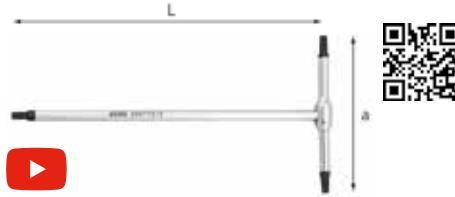

## 280 TTX

T-handle keys for TORX® screws

- Special Chrome Vanadium steel
- Chrome plated finish with burnished tips

n°	a mm	L mm	code	item/size
T6	62	125	U02800650	2
T7	62	125	U02800651	2
T8	62	125	U02800652	2
T9	62	125	U02800653	2
T10	75	150	U02800654	2
T15	75	150	U02800655	2
T20	75	150	U02800656	2
T25	90	180	U02800657	2
T27	90	180	U02800658	2
T30	90	180	U02800659	2
T40	105	210	U02800660	2
T45	105	210	U02800661	2
T50	125	250	U02800662	2
T55	150	300	U02800663	2
T60	150	320	U02800664	2



## 280 TTX/SE7

Set of 7 T-handle keys for TORX® screws

pcs	description	item/size
7	T-handle keys for TORX® screws / T27-T30-T40-T45-T50-T55-T60	280 TTX

kg	code	item/size
1,7	U02800687	1



## 280 TTX/SE8

Set of 8 T-handle keys for TORX® screws

pcs	description	item/size
8	T-handle keys for TORX® screws / T6-T7-T8-T9-T10-T15-T20-T25	280 TTX

kg	code	item/size
230	U02800686	1

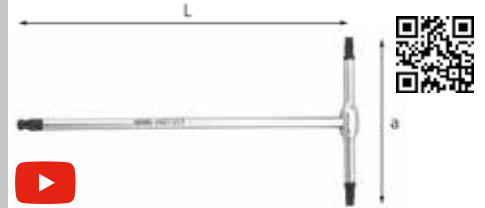

## 280 TSTX

T-handle keys with spherical head for TORX® screws

- Special Chrome Vanadium steel
- Chrome plated finish with burnished tips to ensure perfect fit with the screws
- Model with a working angle up to 30° with respect to the axis of the screw
- Spherical head for exceptional accessibility

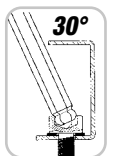

n°	a mm	L mm	kg	code	item/size
T15	75	150	23	U02800775	1
T20	75	150	23	U02800776	1
T25	90	180	60	U02800777	1
T30	90	180	60	U02800779	1



## 280 TSTX/SE4

Set of 4 T-handle keys with spherical head for TORX® screws

pcs	description	item/size
4	T-handle keys with spherical head for TORX® screws/T15-T20-T25-T30	280 TSTX

kg	code	item/size
382	U02800790	1



NEW

## 280 TQ

### T-key bit holder

- Double magnetic bit-holder 1/4"
- Maximum capacity of the bit-holder: 6 mm hexagonal bit or T40 TORX® bit
- Single end with 1/4" sockets square drive
- Special Chrome Vanadium steel
- Chrome plated finish

L mm	a mm	code	
210	110	U02800800	1



### FIX BAR



### 1/4" SOCKETS SQUARE DRIVE



### BIT-HOLDER 1/4"

hex bits up to 6 mm. TORX® bits up to T40.



## 280 TX

### Angled keys for TORX® screws

- Special Chrome Vanadium steel
- Burnished finish

n°	a mm	L mm	code	
T6	16	42	U02800560	5
T7	16	48	U02800561	5
T8	16	48	U02800562	5
T9	16	48	U02800563	5
T10	17	51	U02800564	5

## 280 TX

n°	a mm	L mm	code	
T15	18	54	U02800565	5
T20	20	57	U02800566	5
T25	20	60	U02800567	5
T27	21	63	U02800568	5
T30	24	70	U02800569	5
T40	26	76	U02800570	5
T45	28	82	U02800571	5
T50	31	94	U02800572	5
T55	35	108	U02800573	5
T60	38	120	U02800574	5

## 280 TX/SE7

### Set of 7 keys for TORX® screws

pcs description	item/size
7 Angled keys for TORX® screws / T27-T30-T40-T45-T50-T55-T60	280 TX

á gr	code	
475	U02800584	1

## 280 TX/SE8

### Set of 8 keys for TORX® screws

pcs description	item/size
8 Angled keys for TORX® screws / T6-T7-T8-T9-T10-T15-T20-T25	280 TX

á gr	code	
40	U02800583	1

## 280 TX/S8

### Set of 8 keys for TORX® screws

- Burnished finish
- Supplied with pocket holder in steel covered with shock resistant plastic

pcs description	item/size
8 Angled keys for TORX® screws / T9-T10-T15-T20-T25-T27-T30-T40	280 TX

á gr	code	
220	U02800194	1



## 280 TX/S8C

### Set of 8 angled keys for TORX® screws

- Special Chrome Vanadium steel
- Burnished finish
- Supplied with plastic holder

pcs description	item/size
8 Angled keys for TORX® screws / T10-T15-T20-T25-T27-T30-T40-T45	280 TX
1 Empty plastic holder	280 TX/SV8

á gr	code	
100	U02800576	1

## 280 TX/SV8

### Empty plastic holder

- For angled keys 280 TX/S8C - 280 STX/S8C - 280 LTSTX/S8

code	
U02800003Q	1



## 280 STX

### Angled keys for TORX® Tamper Resistant screws

- For hex socket screws
- Special Chrome Vanadium steel
- Burnished finish

n°	a mm	L mm	code	
T10	17	51	U02800410	5
T15	18	54	U02800411	5
T20	20	57	U02800412	5
T25	20	60	U02800413	5
T27	22	64	U02800414	5
T30	24	70	U02800415	5
T40	26	76	U02800416	5
T45	26	76	U02800417	5



## 280 STX/S8

### Set of 8 keys for TORX® Tamper Resistant screws

- Burnished finish
- Supplied with pocket holder in steel covered with shock resistant plastic

pcs	description	item/size
8	Angled keys for TORX® Tamper Resistant screws / T9-T10-T15-T20-T25-T27-T30-T40	280 STX

á gr	code	
215	U02800195	1



## 280 STX/S8C

### Set of 8 angled keys for TORX® Tamper Resistant screws

- Special Chrome Vanadium steel
- Burnished finish
- Supplied with plastic holder

pcs	description	item/size
8	Angled keys for TORX® Tamper Resistant screws / T10-T15-T20-T25-T27-T30-T40-T45	280 STX
1	Empty plastic holder	280 TX/SV8

á gr	code	
100	U02800577	1



## 280 LTSTX

### Long angled keys with spherical head for TORX® screws

- Model with spherical head giving a working angle of up to 25° with respect to the axis of the screw (excepting the T9 and T10 mm sizes)
- Special Molybdenum Vanadium steel
- Burnished finish

n°	a mm	L mm	code	
T9	16	80	U02800075	2
T10	16	85	U02800076	2
T15	18	90	U02800026	2
T20	19	95	U02800027	2
T25	20	100	U02800028	2
T27	21	105	U02800029	2
T30	24	115	U02800030	2
T40	26	125	U02800031	2
T45	28	130	U02800032	2
T50	32	150	U02800033	2



## 280 LTSTX

### Set of 8 long angled keys with spherical head for TORX® screws

- Model with spherical head giving a working angle of up to 25° with respect to the axis of the screw (excepting the T10 mm size)
- Special Molybdenum Vanadium steel
- Burnished finish
- Supplied with plastic holder

pcs	description	item/size
8	Long angled keys with spherical head for TORX® screws / T10-T15-T20-T25-T27-T30-T40-T45	280 LTSTX
1	Empty plastic holder	280 TX/SV8

á gr	code	
350	U02800078	1



## 280 XLTS

### Long angled hexagon keys with spherical head

- For hex socket screws
- Model giving a working angle of up to 25° with respect to the axis of the screw
- Special Chrome Vanadium steel
- Burnished finish

mm	a mm	L mm	code	
2	16	100	U02800160	5
2,5	18	111	U02800161	5
3	20	124	U02800162	5
4	25	138	U02800164	5
5	28	159	U02800166	5
6	32	179	U02800167	5
8	36	198	U02800169	5
10	40	221	U02800171	5



## 280 XLTS/S9

### Set of 9 long hexagon keys with spherical head

- For hex socket screws
- Model giving a working angle of up to 25° with respect to the axis of the screw
- Special Chrome Vanadium steel
- Burnished finish
- Supplied with plastic holder

pcs	description	item/size
1	Long angled hexagon keys with spherical head	280 LTS/1,5
8	Long angled hexagon keys with spherical head / 2-2,5-3-4-5-6-8-10	280 XLTS
1	Empty plastic holder	280 LTS/SV9

á gr	code	
380	U02800184	1



## 280 LTS/SV9

### Empty plastic holder

- For angled hexagon keys 280 S9 - 280 N/S9 - 280 L/S9 - 280 LTS/S9 - 280 XLTS/S9

á gr	code	
30	U0280001Q	1



## 280 XZN

### Angled keys for XZN screws

- Special Chrome Vanadium steel
- Burnished finish

for screws M	a mm	L mm	code	
5	25	72	U02800541	5
6	29	81	U02800542	5
8	32	90	U02800543	5
10	36	100	U02800544	5
12	40	112	U02800545	5
14	45	125	U02800546	2
16	55	140	U02800547	2



## 280 XZN/S5

### Set of 5 keys for XZN screws

- M5-M6-M8-M10-M12
- Supplied with sheet steel pocket holder
- Nickel plated finish

á gr	code	
430	U02800550	1

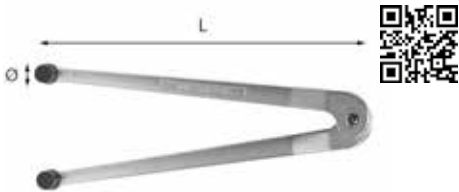

## 281 C

### Adjustable pin-type face wrenches with round pins

- For ring nuts with holes

Ø mm	⊕ mm	L mm	code	
2	10÷40	160	U02810103	2
3	12÷60	160	U02810104	2
4	12÷60	160	U02810105	2
5	12÷60	160	U02810106	2
6	14÷100	160	U02810107	2
7	14÷100	215	U02810108	2
8	14÷100	215	U02810109	2
10	22÷125	215	U02810110	2
12	22÷125	215	U02810111	2



## 281 CR

### Spare pins

- Spare part for wrenches 281 C  
- Pack 2 pcs.

Ø mm	code	
2	U02810412Q	1
3	U02810413Q	1
4	U02810414Q	1
5	U02810415Q	1
6	U02810416Q	1
7	U02810417Q	1
8	U02810418Q	1
10	U02810419Q	1
12	U02810420Q	1



## 281 DT

### Adjustable pin-type face wrenches with round pins

- The wrench is adjusted as a compass, by turning the centre screw  
- Each wrench is supplied with 4 sets of 2 hooks  
- Satin chrome finish

⊕ mm	L mm	code	
20÷100	245	U02810115	1



## 281 DQ

### Adjustable pin-type face wrenches with square pins

- The wrench is adjusted as a compass, by turning the centre screw  
- Each wrench is supplied with 4 sets of 2 hooks  
- Satin chrome finish

⊕ mm	L mm	code	
20÷100	245	U02810116	1



## 282

UNI 6752 DIN 1810

### Hook wrenches with square pin

- For ring nuts  
- Chrome plated finish

⊕ mm	b mm	L mm	code	
16-18-20	2	108	U02820102	2
22-25-28	2,5	135	U02820103	2
30-32	2,5	135	U02820104	2
34-36-38	3	170	U02820105	2
40-42	3	170	U02820106	2
45-50	3,5	206	U02820107	2
52-55	3,5	206	U02820108	2
58-62-65	4	241	U02820109	2
68-70-75	4	241	U02820110	2
80-85-90	5	280	U02820111	2
92-95-100	5	280	U02820112	2
110-115	5	334	U02820113	1
120-130	5	334	U02820114	1
135-145	6	385	U02820115	1
155-165	6	385	U02820116	1
180-195	6	466	U02820117	1



## 282 SN

### Adjustable hook wrenches with square pin

- For working with a single wrench on nuts of different sizes  
- Chrome plated finish

⊕ mm	b mm	L mm	code	
15÷35	3,5	168	U02820301	1
35÷50	4	202	U02820302	1
50÷80	5	280	U02820303	1
80÷120	5,5	345	U02820304	1
120÷180	9,5	492	U02820305	1



## 282 TSN

### Adjustable hook wrenches with round pin

- For working with a single wrench on nuts of different sizes  
- Chrome plated finish

⊕ mm	b mm	L mm	code	
15÷35	3	168	U02820321	1
35÷50	4	202	U02820322	1
50÷80	5	280	U02820323	1
80÷120	6	345	U02820324	1
120÷180	8	492	U02820325	1

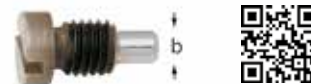

## 282 TSNA

### Spare pins

- Spare part for wrench 282 TSN

⊕ mm	b mm	code	
15÷35	3	U02820331	1
35÷50	4	U02820332	1
50÷80	5	U02820333	1
80÷120	6	U02820334	1
120÷180	8	U02820335	1



## 282 S10

### Assortment in ABS case with pin wrenches for round and square ring nuts (10pcs.)

- For rings with holes bored on the face  
- The wrench is adjustable by turning the centre screw  
- Removable pins  
- Capacity: 20 to 100 mm  
- Satin chrome finish  
- High resistance ABS case with quick closing system  
- Empty inner foam module: code U05191054Q

LxPxH mm	Kg	code	
330x215x60	1,8	U02820200	1



## 283

ISO 10104

### Double ended offset bihexagonal ring wrenches

- Chrome Vanadium steel  
- Satin Chrome finish

Ø mm	L mm	code	
6x7	167	U02831302	1
8x9	182	U02831303	1
8x10	182	U02831304	1
10x11	197	U02831305	1



283

Ø mm	L mm	code	
12x13	218	U02831306	1
13x17	245	U02831308	1
14x15	238	U02831309	1
16x17	258	U02831311	1
17x19	290	U02831312	1
18x19	290	U02831313	1
19x22	296	U02831314	1
20x22	316	U02831315	1
21x23	316	U02831316	1
22x24	324	U02831317	1
24x26	328	U02831318	1
24x27	328	U02831319	1
25x28	345	U02831320	1
27x29	353	U02831321	1
27x32	353	U02831323	1
30x32	360	U02831324	1
34x36	440	U02831327	1
36x41	440	U02831329	1
46x50	510	U02831334	1



**283 SE5**

**Set of 5 offset bihexagonal ring wrenches**

pcs	description	item/size
5	Double ended offset bihexagonal ring wrenches /6x7-10x11-12x13-14x15-16x17	283

kg	code	
700	U02831402	1



**283 SE9**

**Set of 9 offset bihexagonal ring wrenches**

pcs	description	item/size
9	Double ended offset bihexagonal ring wrenches /6x7-8x9-10x11-12x13-14x15-16x17-18x19-20x22-21x23	283

kg	code	
1,8	U02831405	1



**283 SE10**

**Set of 10 offset bihexagonal ring wrenches**

pcs	description	item/size
10	Double ended offset bihexagonal ring wrenches /6x7-8x9-10x11-12x13-14x15-16x17-18x16-20x22-24x27-30x32	283

code	
U02831406	1



**283 SE12**

**Set of 12 offset bihexagonal ring wrenches**

pcs	description	item/size
12	Double ended offset bihexagonal ring wrenches /6x7-8x9-10x11-12x13-14x15-16x17-18x19-20x22-21x23-24x26-25x28-30x32	283

kg	code	
3,6	U02831403	1



**283 SE13**

**Set of 13 offset bihexagonal ring wrenches**

pcs	description	item/size
13	Double ended offset bihexagonal ring wrenches /6x7-8x9-10x11-12x13-14x15-16x17-18x19-20x22-21x23-24x26-25x28-27x29-30x32	283

kg	code	
4,2	U02831404	1



**283 B8**

**Set of 8 offset bihexagonal ring wrenches**

- Chrome Vanadium steel
- Satin Chrome finish
- Supplied in plastic pouch

pcs	description	item/size
8	Double ended offset bihexagonal ring wrenches /6x7-8x9-10x11-12x13-14x15-16x17-18x19-20x22	283

kg	code	
1,4	U02831411	1



**283 BV8**

**Empty pouch**

- For wrench set 283 B8

code	
U02830602	1



**283 R13**

**Set of 13 offset bihexagonal ring wrenches**

- Chrome Vanadium steel
- Satin Chrome finish
- Supplied with holder in sheet steel

pcs	description	item/size
13	Double ended offset bihexagonal ring wrenches /6x7-8x9-10x11-12x13-14x15-16x17-18x19-20x22-21x23-24x26-25x28-27x29-30x32	283
1	Empty holder for double ended offset ring wrenches 283 RV13	

kg	code	
4,3	U02831414	1

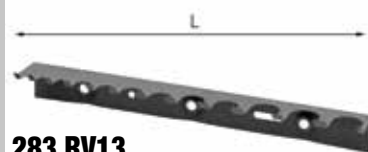

**283 RV13**

**Empty holder for double ended offset ring wrenches**

- Enamelled sheet steel
- Supplied without screws
- For bihexagonal ring wrenches 283 R13

L mm	kg	code	
390	270	U02830600	1



**283 S13**

**Set of 13 offset bihexagonal ring wrenches**

- Chrome Vanadium steel
- Satin Chrome finish
- Supplied with holder in sheet steel

pcs	description	item/size
13	Double ended offset bihexagonal ring wrenches /6x7-8x9-10x11-12x13-14x15-16x17-18x19-20x22-21x23-24x26-25x28-27x29-30x32	283
1	Empty metal display stand	252 SV13

kg	code	
4,3	U02831417	1



**284**

**Double ended offset bihexagonal ring wrench for scaffolds**

- Chrome Vanadium steel
- Satin Chrome finish

Ø mm	L mm	kg	code	
21x22	315	570	U02840101	5

## COMBINATION WRENCHES



+ 30% longer than a standard combination wrench 285

PAGE  
**120**



 YouTube

### **285 X**

#### **TOP PERFORMANCE**

- Open/box end with special profiles
- Perfect on new hexagon and effective on damaged bolt
- + 30% longer than a standard combination wrench 285



PAGE  
**114**



 YouTube

### **285**

#### **THE ICONIC WRENCH**

- Inclined open end angled at 15° as regards to wrench axis.
- Special ring shape Ideal for operations on nuts difficult to reach.
- Double T section excellent resistance to flexion.



PAGE  
**120**

### **285 J**

#### **ESSENTIAL MODEL**

- Thin open end angled at 15°
- Bihexagonal head bent at 15°

## RATCHET COMBINATION WRENCHES



PAGE  
**118**

### **285 KF**

#### **The articulated wrench**

- Open end with anti-slip system of the hexagon during operations
- Articulated head



PAGE  
**116**

### **285 KA**

#### **The top model**

- Open end with anti-slip system of the hexagon during operations
- Spring steel retaining ring integrated into the bihexagonal head for better grip on the nut



YouTube



PAGE  
**118**

### **285 KB**

#### **The flat key**

- Flat ratchet head to facilitate accessibility in hard to reach areas
- Change of rotation direction by turning the key 180°



### D 284

Double ended offset bihexagonal ring wrench for scaffolds



Ø mm	L mm	code	
21x22	315	U02840101D	1

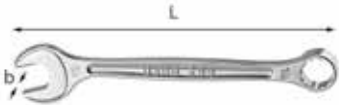

### 285

ISO 7738

#### Combination wrenches

- Chrome Vanadium steel
- Thin open end angled at 15°
- Ergonomic grip
- Bihexagonal head bent at 15°
- Ring head with hexagonal profile only for size 5,5 mm, bihex for rest of range

Ø mm	L mm	b mm	code	
5,5	115	3,8	U02850700	5
6	115	4,0	U02850701	5
7	122	4,1	U02850702	5
8	133	4,6	U02850703	5
9	138	4,6	U02850704	5
10	145	5,1	U02850705	5
11	155	5,2	U02850706	5
12	162	5,4	U02850707	5
13	170	5,7	U02850708	5
14	180	5,9	U02850709	5
15	185	6,1	U02850710	5
16	195	6,6	U02850711	5
17	202	6,6	U02850712	5
18	208	7,4	U02850713	5
19	216	7,4	U02850714	5
20	224	7,5	U02850715	1
21	233	8,3	U02850716	1
22	248	8,6	U02850717	5
23	257	8,9	U02850718	1
24	267	8,9	U02850719	5
25	274	9,8	U02850720	1
26	285	9,8	U02850721	1
27	295	9,8	U02850722	1
28	305	9,8	U02850723	1
29	320	10,5	U02850724	1
30	340	10,5	U02850725	1
32	355	11,0	U02850726	1
34	390	11,0	U02850727	1
35	430	11,5	U02850728	1
36	440	12,8	U02850729	1
38	450	13,0	U02850730	1
41	460	14,0	U02850731	1



### D 285

ISO 7738

#### Combination wrenches

- Thin open end angled at 15°
- Ergonomic grip
- Bihexagonal head bent at 15°



Ø mm	L mm	b mm	code	
6	115	4,0	U02850701D	1
7	122	4,1	U02850702D	1
8	133	4,6	U02850703D	1
9	138	4,6	U02850704D	1
10	145	5,1	U02850705D	1
11	155	5,2	U02850706D	1
12	162	5,4	U02850707D	1
13	170	5,7	U02850708D	1
14	180	5,9	U02850709D	1
15	185	6,1	U02850710D	1
16	195	6,6	U02850711D	1
17	202	6,6	U02850712D	1
18	208	7,4	U02850713D	1
19	216	7,4	U02850714D	1
20	224	7,5	U02850715D	1
21	233	8,3	U02850716D	1
22	248	8,6	U02850717D	1
23	257	8,9	U02850718D	1
24	267	8,9	U02850719D	1
25	274	9,8	U02850720D	1
26	285	9,8	U02850721D	1
27	295	9,8	U02850722D	1
28	305	9,8	U02850723D	1
29	320	10,5	U02850724D	1
30	340	10,5	U02850725D	1
32	355	11,0	U02850726D	1
34	390	11,0	U02850727D	1
35	430	11,5	U02850728D	1
36	440	12,8	U02850729D	1



### 285 SE5

#### Set of 5 combination wrenches

pcs description	item/size
5 Combination wrenches/8-10-13-17-19	285

code	
U02850858	1



### 285 SE17

#### Set of 17 combination wrenches

pcs description	item/size
17 Combination wrenches/6-7-8-9-10-11-12-13-14-15-16-17-18-19-20-21-22	285

kg	code	
1,6	U02850860	1



### 285 SE26

#### Set of 26 combination wrenches

pcs description	item/size
26 Combination wrenches /6-7-8-9-10-11-12- 13-14-15-16-17-18-19-20-21-22-23-24-25-26-27-28-29-30-32	285

kg	code	
4,9	U02850861	1



### 285 B17

#### Set of 17 combination wrenches

- Thin open end angled at 15°
- Ergonomic grip
- Bihexagonal head bent at 15°
- Supplied in plastic pouch

pcs description	item/size
17 Combination wrenches/6-7-8-9-10-11-12-13-14-15-16-17-18-19-20-21-22	285
1 Empty pouch	285 BV

kg	code	
1,8	U02850866	1



## 285

Combination wrench



YouTube



#### Thin head

Exceptional accessibility.



#### Double T section

Excellent resistance to flexion.



#### Special ring shape

Ideal for operations on nuts difficult to reach.



## 285 BV

### Empty pouch

- For combination wrench sets 285 B17

code	item/size
U02850203	1



## 285 R17

### Set of 17 combination wrenches

- Thin open end angled at 15°
- Ergonomic grip
- Bihexagonal head bent at 15°
- Supplied with metal holder

pcs description	item/size
17 Combination wrenches /6-7-8-9-10-11-12-13-14-15-16-17-18-19-20-21-22	285
1 Empty holder for combination wrenches	285 RV17

kg	code	item/size
1,9	U02850868	1



## 285 RV17

### Empty holder for combination wrenches

- Enamelled sheet steel
- Supplied without screws
- For combination wrench sets 285 R17

L mm	code	item/size
350	U02850200	1



## 285 S13

### Set of 13 combination wrenches

- Thin open end angled at 15°
- Ergonomic grip
- Bihexagonal head bent at 15°
- Supplied with holder in sheet steel

pcs description	item/size
13 Combination wrenches /6-7-8-10-11-12-13-14-15-17-19-22-24	285
1 Empty metal display stand	252 SV13

kg	code	item/size
2,6	U02850873	1



## 285 DS8

### Set of 8 combination wrenches

- Thin open end angled at 15°
- Ergonomic grip
- Bihexagonal head bent at 15°
- Supplied with plastic holder

pcs description	item/size
8 Combination wrenches /8-10-11-12-13-14-17-19	285
1 Empty plastic stand	285 KDV8

gr	code	item/size
900	U02850863	1



## 285 KDV8

### Empty plastic stand

- For combination wrench sets 285 KA/DS8, 285 DS8, 285KF/DS8

code	item/size
U02850002Q	1



## 285 DS12

### Set of 12 combination wrenches

- Thin open end angled at 15°
- Ergonomic grip
- Bihexagonal head bent at 15°
- Supplied with plastic holder

pcs description	item/size
12 Combination wrenches /7-8-10-11-12-13-14-15-16-17-18-19	285
1 Empty plastic stand	285 KDV12

kg	code	item/size
1,5	U02850864	1



## 285 KDV12

### Empty plastic stand

- For wrench set 285 KA/DS12 and 285 DS12

code	item/size
U02850004Q	1



## 285 DS14

### Set of 14 combination wrenches

- Thin open end angled at 15°
- Ergonomic grip
- Bihexagonal head bent at 15°
- Supplied with plastic holder

pcs description	item/size
14 Combination wrenches /7-8-10-11-12-13-14-15-16-17-18-19-22-24	285
1 Empty plastic holder	285 DSV14

Kg	code	item/size
1,8	U02850865	1



## 285 DSV14

### Empty plastic holder

- For sets of combination wrenches 285 DS14

code	item/size
U02850006Q	1



## 285 P

ISO 7738

### Combination wrenches, inch sizes

- Thin open end angled at 15°
- Ergonomic grip
- Bihexagonal head bent at 15°

Ø"	L mm	b mm	code	item/size
1/4	115	4,0	U02850821	1
5/16	133	4,6	U02850822	1
3/8	145	5,1	U02850823	1
7/16	155	5,2	U02850824	1
1/2	170	5,7	U02850825	1
9/16	180	5,9	U02850826	1
5/8	195	6,6	U02850827	1
11/16	202	6,6	U02850828	1
3/4	216	7,4	U02850829	1
13/16	224	7,5	U02850830	1
7/8	248	8,6	U02850831	1
15/16	267	8,9	U02850832	1
1	274	9,8	U02850833	1
1 1/16	295	9,8	U02850834	1
1 1/8	305	9,8	U02850835	1
1 1/4	355	11,0	U02850836	1
1 5/16	390	11,0	U02850837	1
1 3/8	430	11,5	U02850838	1
1 7/16	440	12,8	U02850839	1
1 1/2	450	13,0	U02850840	1



### 285 P/SE5

#### Set of 5 combination wrenches, inch sizes

pcs	description	item/size
5	Combination wrenches, inch sizes / 1/4-3/8-7/16-1/2-9/16	285 P

code	img
U02850856	



### 285 P/SE13

#### Set of 13 combination wrenches, inch sizes

pcs	description	item/size
13	Combination wrenches, inch sizes / 1/4-5/16-3/8-7/16-1/2-9/16-5/8-11/16-3/4-13/16-7/8-15/16-1"	285 P

kg	code	img
1,6	U02850862	



### 285 P/S13

#### Set of 13 combination wrenches, inch sizes

- Thin open end angled at 15°
- Ergonomic grip
- Bihexagonal head bent at 15°
- Supplied with holder in sheet steel

pcs	description	item/size
13	Combination wrenches, inch sizes / 3/8-7/16-1/2-9/16-5/8-11/16-3/4-13/16-7/8-15/16-1 1/8-1 5/16-1 1/2"	285 P
1	Empty metal display stand	252 SV13

kg	code	img
2,6	U02850871	



### 285 KA

ISO 691

#### Reversible ratchet combination wrenches with locking ring

- Steel ring integrated in the bihexagonal head for better grip
- Open end with anti-slip system of the hexagon
- Integrated inversion lever
- Bihexagonal head and open end bent at 15°
- Working angle of 5°

Ø mm	L mm	code	img
6	128	U02856006	
7	140	U02856007	
8	140	U02856008	
9	149	U02856009	
10	158	U02856010	
11	165	U02856011	
12	171	U02856012	
13	178	U02856013	
14	190	U02856014	
15	199	U02856015	
16	208	U02856016	
17	225	U02856017	
18	236	U02856018	
19	247	U02856019	
21	287	U02856021	
22	287	U02856022	
24	320	U02856024	
27	356	U02856027	
30	400	U02856030	
32	422	U02856032	
34	455	U02856034	
36	487	U02856036	
38	487	U02856038	
41	565	U02856041	



### D 285 KA

#### Reversible ratchet combination wrenches with locking ring

Ø mm	L mm	code	img
6	128	U02856006D	
7	140	U02856007D	
8	140	U02856008D	
9	149	U02856009D	
10	158	U02856010D	
11	165	U02856011D	
12	171	U02856012D	
13	178	U02856013D	
14	190	U02856014D	
15	199	U02856015D	
16	208	U02856016D	
17	225	U02856017D	
18	236	U02856018D	
19	247	U02856019D	
22	287	U02856022D	
24	320	U02856024D	
27	356	U02856027D	
30	400	U02856030D	
32	422	U02856032D	



### 285 KA/SE5

#### Set of 5 reversible ratchet combination wrenches with locking ring

pcs	description	item/size
5	Reversible ratchet combination wrenches with locking ring/8-10-13-17-19	285 KA

kg	code	img
450	U02856074	



### 285 KA/SE12

#### Set of 12 reversible ratchet combination wrenches with locking ring

pcs	description	item/size
12	Reversible ratchet combination wrenches with locking ring/8-9-10-11-12-13-14-15-16-17-18-19	285 KA

kg	code	img
1,5	U02856078	



### 285 KA/B8

#### Set of 8 reversible ratchet combination wrenches with locking ring

- 285 KA 8-10-11-12-13-14-17-19 mm
- Steel ring integrated in the bihexagonal head for better grip
- Open end with anti-slip system of the hexagon
- Integrated inversion lever
- Bihexagonal head and open end bent at 15°
- Working angle of 5°
- Supplied in plastic pouch

pcs	description	item/size
8	Reversible ratchet combination wrenches with locking ring/8-10-11-12-13-14-17-19	285 KA
1	Empty pouch	285 K/BV8

kg	code	img
900	U02856066	



## 285 K/BV8

### Empty pouch

- For sets of combination wrenches 285 KA/B8

code	item/size
U02850518Q	1



## 285 KA/B12

### Set of 12 reversible ratchet combination wrenches with locking ring

- Steel ring integrated in the bihexagonal head for better grip
- Open end with anti-slip system of the hexagon
- Integrated inversion lever
- Bihexagonal head and open end bent at 15°
- Working angle of 5°
- Supplied in plastic pouch

pcs	description	item/size
12	Reversible ratchet combination wrenches with locking ring /8-9-10-11-12-13-14-15-16-17-18-19	285 KA
1	Empty pouch	285 K/BV12

kg	code	item/size
1,5	U02856070	1



## 285 K/BV12

### Empty pouch

- For sets of combination wrenches 285 KA/B12

code	item/size
U02850519Q	1



## 285 KA/DS8

### Set of 8 reversible ratchet combination wrenches with locking ring

- Steel ring integrated in the bihexagonal head for better grip
- Open end with anti-slip system of the hexagon
- Integrated inversion lever
- Bihexagonal head and open end bent at 15°
- Working angle of 5°
- Supplied with plastic holder

pcs	description	item/size
8	Reversible ratchet combination wrenches with locking ring/8-10-11-12-13-14-17-19	285 KA
1	Empty plastic stand	285 KDV8

gr	code	item/size
900	U02856058	1



## 285 KDV8

### Empty plastic stand

- For combination wrench sets 285 KA/DS8, 285 DS8, 285KF/DS8

code	item/size
U02850002Q	1



## 285 KA/DS12

### Set of 12 reversible ratchet combination wrenches with locking ring

- Steel ring integrated in the bihexagonal head for better grip
- Open end with anti-slip system of the hexagon
- Integrated inversion lever
- Bihexagonal head and open end bent at 15°
- Working angle of 5°
- Supplied with plastic holder

pcs	description	item/size
12	Reversible ratchet combination wrenches with locking ring /7-8-10-11-12-13-14-15-16-17-18-19	285 KA
1	Empty plastic stand	285 KDV12

kg	code	item/size
1,5	U02856062	1



## 285 KDV12

### Empty plastic stand

- For wrench set 285 KA/DS12 and 285 DS12

code	item/size
U02850004Q	1



# 285 KA

Reversible ratchet combination wrench



YouTube



**Open end with anti-slip system of the nut**  
Greater hold during the operations.



**Optimal position**  
**Spring steel ring integrated into the bihexagonal eye**  
Keeps the position on the nut during the operations.



## 285 KB

ISO 691

### Flat ratchet combination wrenches

- Open end bent at 15°
- Working angle at 5°

Ø mm	L mm	code	
6	108	U02856306	5
7	108	U02856307	5
8	111	U02856308	5
9	123	U02856309	5
10	131	U02856310	5
11	147	U02856311	5
12	155	U02856312	5
13	164	U02856313	5
14	182	U02856314	5
15	192	U02856315	5
16	202	U02856316	5
17	223	U02856317	5
18	234	U02856318	5
19	246	U02856319	5
22	325	U02856322	5
24	325	U02856324	5



## 285 KB/SE5

### Set of 5 flat ratchet combination wrenches

- Open end bent at 15°
- Working angle at 5°
- Supplied in plastic bag

pcs	description	item/size
5	Flat ratchet combination wrenches / 8-10-13-17-19	285 KB

Ø gr	code	
570	U02856338	1



NEW

## 285 KB/DS7

### Set of 7 flat ratchet combination wrenches

- Open end angled at 15°
- Bihexagonal head bent at 15°
- Mat chromed finishing
- Supplied with plastic holder

pcs	description	item/size
7	Flat ratchet combination wrenches/ 8-10-12-13-14-17-19	285 KB
1	Empty plastic stand	285 KBV7

code	
U02856341	1



NEW

## 285 KBV7

### Empty plastic stand

- For combination wrench sets 285 KB/DS7 and 285 J/DS7

code	
U02856341Q	1



NEW

## 285 KB/DS12

### Set of 12 flat ratchet combination wrenches

- Open end angled at 15°
- Bihexagonal head bent at 15°
- Mat chromed finishing
- Supplied with plastic holder

pcs	description	item/size
12	Flat ratchet combination wrenches/ 8-9-10-11-12-13-14-15-16-17-18-19	285 KB
1	Empty plastic stand	285 KBV12

code	
U02856342	1



NEW

## 285 KBV12

### Empty plastic stand

code	
U02856342Q	1



## 285 KF

ISO 691

### Hinged jointed reversible ratchet combination wrenches

- Open end with anti-slip system of the hexagon
- Ratchet working angle adjustable at 180°
- Open end angled at 15°
- Working angle at 5°
- Chrome plated finish



Ø mm	L mm	code	
8	127,5	U02856108	5
9	132	U02856109	5
10	136,5	U02856110	5
11	141,5	U02856111	5
12	148	U02856112	5
13	155	U02856113	5
14	161	U02856114	5
15	170	U02856115	5
16	180	U02856116	5
17	191	U02856117	5
18	204	U02856118	5
19	216	U02856119	5



## 285 KF/SE5

### Set of 5 hinged jointed reversible ratchet combination wrenches

pcs	description	item/size
5	Hinged jointed reversible ratchet combination wrenches/8-10-13-17-19	285 KF

Ø gr	code	
580	U02856160	1



## 285 KF/SE12

### Set of 12 hinged jointed reversible ratchet combination wrenches

pcs	description	item/size
12	Hinged jointed reversible ratchet combination wrenches/ 8-9-10-11-12-13-14-15-16-17-18-19	285 KF

kg	code	
1,8	U02856161	1





## 285 KF/DS8

### Set of 8 hinged jointed ratchet combination wrenches

- Open end with anti-slip system of the hexagon
- Hinged jointed ratchet head adjustable at 180°
- Open end angled at 15°
- Working angle at 5°
- Supplied with plastic holder



pcs	description	item/size
8	Hinged jointed reversible ratchet combination wrenches /8-10-11-12-13-14-17-19	285 KF
1	Empty plastic stand	285 KDV8

kg	code	img
1	U02856158	



## 285 KDV8

### Empty plastic stand

- For combination wrench sets 285 KA/DS8, 285 DS8, 285KF/DS8

code	img
U02850002Q	



## 285 C

ISO 7738

### Short combination wrenches

- Ring and open head bent at 15°
- Ring head with hexagonal profile up to size 5,5 mm, bihexagonal for larger sizes

Ø mm	L mm	code	img
3,2	77	U02850601	
4	77	U02850602	
5	82	U02850603	
5,5	82	U02850604	
6	90	U02850605	
7	90	U02850606	
8	94	U02850607	
9	98	U02850608	
10	103	U02850609	
11	109	U02850610	
12	127	U02850611	
13	141	U02850612	
14	147	U02850613	
15	152	U02850614	
16	158	U02850615	
17	165	U02850616	



## 285 C/SE10

### Set of 10 short combination wrenches

- Ring and open head bent at 15°
- Ring head with hexagonal profile up to size 5,5 mm, bihexagonal for larger sizes
- Supplied in nylon pouch

pcs	description	item/size
10	Short combination wrenches / 4-5-6-7-8-9-10-11-12-13	285 C
1	Empty pouch	285 C/SEV10

kg	code	img
300	U02850682	



## 285 C/SEV10

### Empty pouch

- For wrench set 285 C/SE10

code	img
U02850622	



## 285 C/SE16

### Set of 16 short combination wrenches

- Ring and open head bent at 15°
- Ring head with hexagonal profile up to size 5,5 mm, bihexagonal for larger sizes
- Supplied in nylon pouch

pcs	description	item/size
10	Short combination wrenches /3,2-4-5-5,5-6-7-8-9-10-11-12-13-14-15-16-17	285 C
1	Empty pouch	285 C/SEV16

kg	code	img
700	U02850683	



## 285 C/SEV16

### Empty pouch

- For wrench set 285 C/SE16

code	img
U02850623	



## 285 L

ISO 7738

### Long combination wrenches

- Bihexagonal and open head bent at 15°
- Shank with double-T profile to guarantee maximum resistance
- Chrome plated finish

Ø mm	L mm	code	img
10	212	U02850304	
11	225	U02850305	
12	238	U02850306	
13	251	U02850307	
14	264	U02850308	
15	277	U02850310	
16	290	U02850311	
17	303	U02850312	
18	316	U02850313	
19	329	U02850314	
20	342	U02850315	
21	355	U02850316	
22	368	U02850317	
23	381	U02850318	
24	394	U02850319	
25	407	U02850320	
26	420	U02850321	
27	433	U02850322	
28	446	U02850323	
30	472	U02850324	
32	498	U02850325	
34	524	U02850326	
36	550	U02850327	
38	576	U02850328	
41	615	U02850329	
46	680	U02850330	
50	723	U02850331	
55	760	U02850332	
60	800	U02850333	
65	840	U02850334	



## 285 L/SE4

### Set of 4 long combination wrenches

pcs	description	item/size
4	Long combination wrenches/22-24-27-30	285 L

code	img
U02850340	



### 285 L/R13

#### Set of 13 long combination wrenches

- Bihexagonal and open head bent at 15°
- Shank with double-T profile to guarantee maximum resistance
- Supplied with metal holder

pcs	description	item/size
13	Long combination wrenches /10-11-12-13-14-15-16-17-18-19-20-21-22	285 L
1	Empty holder for long combination wrenches	285 L/RV13

kg	code	item/size
2,7	U02850381	1



### 285 L/RV13

#### Empty holder for long combination wrenches

- Enamelled sheet steel
- Supplied without screws
- For wrench set 285 L/R13

L mm	code	item/size
345	U02850300	1



### 285 J

Just **USAG**

#### Combination wrench

- Open end angled at 15°
- Bihexagonal head bent at 15°
- Mat chromed finishing

Ø mm	L mm	b mm	code	item/size
6	100	3,7	U02851701	1
7	110	3,7	U02851702	1
8	120	4,1	U02851703	1
9	130	4,1	U02851704	1
10	140	4,6	U02851705	1
11	150	4,7	U02851706	1
12	160	4,8	U02851707	1
13	170	5,5	U02851708	1
14	180	5,6	U02851709	1
15	190	5,7	U02851710	1
16	200	5,8	U02851711	1
17	210	6,3	U02851712	1
18	220	6,8	U02851713	1
19	230	7,1	U02851714	1
22	265	8	U02851717	1
24	285	8,2	U02851719	1



### 285 J/B16

#### Set of 16 combination wrenches

- 6-7-8-9-10-11-12-13-14-15-16-17-18-19-22-24 mm
- Delivered with roll-up bag

code	item/size
U02851740	1



NEW

### 285 J/DS7

#### Set of 12 combination wrenches

- Open end angled at 15°
- Bihexagonal head bent at 15°
- Mat chromed finishing
- Supplied with plastic holder

pcs	description	item/size
7	Combination wrench/8-10-12-13-14-17-19	285 J
1	Empty plastic stand	285 KBV7

code	item/size
U02851745	1



NEW



### 285 J/DS12

#### Set of 12 combination wrenches

- Open end angled at 15°
- Bihexagonal head bent at 15°
- Mat chromed finishing
- Supplied with plastic holder

pcs	description	item/size
12	Combination wrench/8-9-10-11-12-13-14-15-16-17-18-19	285 J
1	Empty plastic stand	285 KBV12

code	item/size
U02851746	1



### 285 X

NEW

#### Combination wrenches with special profiles

- Open/box end with special profiles: perfect grip with both new and damaged hexagons
- +30% longer than standard combination wrench 285
- Open/box end bent at 15°
- Chrome Vanadium steel with a glossy finish

Ø"	L mm	b mm	code	item/size
8	151	4,4	U02850910	1
9	163	4,8	U02850911	1
10	175	5,3	U02850912	1
11	187	5,9	U02850913	1
12	199	6,1	U02850914	1
13	208	6,3	U02850915	1
14	223	6,6	U02850916	1
15	235	6,8	U02850917	1
16	247	7,1	U02850918	1
17	259	7,5	U02850919	1
18	271	7,6	U02850920	1
19	283	8,9	U02850921	1

New combination wrench 285 X

**XTRA GRIP.**



Perfect on new hexagon, effective on damaged bolt



With the new wrench 285 X, you'll obtain an unbeatable Xtragrip.

- Open/box end with special profiles: perfect on new hexagon and effective on damaged bolt.
- +30% longer than standard combination wrench 285.
- This is an additional model, perfect to be used with standard 285 to increase your performance.



NEW



### 285 X/B8

#### Set of 8 combination wrenches with special profiles

- Open/box end with special profiles: perfect grip with both new and damaged hexagons
- +30% longer than standard combination wrench 285
- Open/box end bent at 15°
- Chrome Vanadium steel with a glossy finish

pcs	description	item/size
8	Combination wrenches with special profiles /8-10-11-12-13-14-17-19	285 X
1	Empty pouch	285 X/BV

code	item/size
U02850950	1



NEW

### 285 X/SE12

#### Set of 12 combination wrenches with special profiles

pcs	description	item/size
12	Combination wrenches with special profiles /8-9-10-11-12-13-14-15-16-17-18-19	285 X
1	Empty pouch	285 X/BV

code	item/size
U02850951	1



NEW

### 285 X/BV

#### Empty pouch

code	item/size
U02850950Q	1



### 288 N

UNI 6746 ISO 2236

#### Double ended tubular box wrenches

- Light-duty wrenches with hexagonal openings, manufactured from a drawn tube
- Transverse holes for drive bars 292
- Chrome plated finish

O mm	a mm	b mm	L mm	code	item/size
4x5	8,5	9,5	92	U02880101	4
5,5x7	10	11,5	100	U02880102	4
6x7	10,5	11,5	100	U02880103	4
8x9	13	14,5	108	U02880104	4
10x11	16	17	116	U02880105	4

### 288 N

O mm	a mm	b mm	L mm	code	item/size
10x13	16	20,5	124	U02880106	4
12x13	19	20,5	124	U02880107	4
14x15	21,5	22,5	132	U02880109	4
16x17	24	26	140	U02880110	4
17x19	26	28,5	148	U02880111	4
18x19	27,5	28,5	148	U02880112	4
20x22	29,5	32	156	U02880114	4
21x23	31	33	163	U02880115	2
24x26	34,5	37	173	U02880117	2
25x28	36	39,5	182	U02880118	2
27x29	38,5	40,5	191	U02880119	2
30x32	42	45	200	U02880121	2



### D 288 N

UNI 6746 ISO 2236

#### Double ended tubular box wrenches

O mm	a mm	b mm	L mm	code	item/size
6x7	10,5	11,5	100	U02880103D	1
8x9	13	14,5	108	U02880104D	1
10x11	16	17	116	U02880105D	1
10x13	16	20,5	124	U02880106D	1



### 288 N/8

#### Set of 8 tubular box wrenches

- Supplied with drive bar 292/1
- Light-duty wrenches with hexagonal openings, manufactured from a drawn tube
- Transverse holes for drive bar 292
- Chrome plated finish

pcs	description	item/size
8	Double ended tubular box wrenches /6x7-8x9-10x11-12x13-14x15-16x17-18x19-20x22	288 N
1	Drive bars	292/1

kg	code	item/size
1	U02880281	1



### 288 N/12

#### Set of 12 tubular box wrenches

- Supplied with drive bars 292/1-2
- Light-duty wrenches with hexagonal openings, manufactured from a drawn tube
- Transverse holes for drive bars 292
- Chrome plated finish

pcs	description	item/size
12	Double ended tubular box wrenches / 6x7-8x9-10x11-12x13-14x15-16x17-18x19-20x22-21x23-24x26-25x28-30x32	288 N
2	Drive bars	292/1-2

kg	code	item/size
2,9	U02880282	1



### 288 N/13

#### Set of 13 tubular box wrenches

- Supplied with drive bars 292/1-2
- Light-duty wrenches with hexagonal openings, manufactured from a drawn tube
- Transverse holes for drive bar 292

pcs	description	item/size
13	Double ended tubular box wrenches/ 6x7-8x9-10x11-12x13-14x15-16x17-18x19-20x22-21x23-24x26-25x28-27x29-30x32	288 N
2	Drive bars	292/1-2

kg	code	item/size
3,5	U02880283	1



### 289 N

UNI 6749 ISO 2236

#### Double ended offset tubular box wrenches

- Light-duty wrenches with hexagonal openings, manufactured from a drawn tube
- Transverse holes for drive bar 292
- Chrome plated finish

O mm	a mm	L mm	code	item/size
5	8,8	95	U02890101	4
5,5	9,3	95	U02890102	4
6	9,9	100	U02890103	4
7	11,1	100	U02890104	4
8	12,7	109	U02890105	4
9	13,9	109	U02890106	4
10	15,5	118	U02890107	4
11	16,7	118	U02890108	4
12	18,9	127	U02890109	4
13	19,5	127	U02890110	4
14	21,2	136	U02890111	4
15	22,3	136	U02890112	4
16	23,4	145	U02890113	4
17	24,5	145	U02890114	4
18	25,8	154	U02890115	4
19	27	154	U02890116	4
20	29,1	163	U02890117	4
21	30,3	163	U02890118	4
22	31,4	172	U02890119	4
24	33,7	180	U02890121	2



### D 289 N

UNI 6749 ISO 2236

#### Double ended offset tubular box wrenches

O mm	a mm	L mm	code	item/size
8	12,7	109	U02890105D	1
10	15,5	118	U02890107D	1
24	33,7	180	U02890121D	1



## 289 N/SE5

### Set of 5 tubular box wrenches

- Light-duty wrenches with hexagonal openings, manufactured from a drawn tube
- Transverse holes for drive bars 292
- Chrome plated finish

pcs	description	item/size
5	Double ended offset tubular box wrenches/ 8-10-13-17-19	289 N

Kg	code	1
2,8	U02890280	1



## 289 N/SE17

### Set of 17 tubular box wrenches

- Supplied with drive bar 292/1
- Light-duty wrenches with hexagonal openings, manufactured from a drawn tube
- Transverse holes for drive bar 292
- Chrome plated finish

pcs	description	item/size
17	Double ended offset tubular box wrenches/ 6-7-8-9-10-11-12-13-14-15-16-17-18-19-20-21-22	289 N
1	Drive bars	292/1

Kg	code	1
2,8	U02890281	1



## 290 E

UNI 6745 ISO 2236

### Double ended tubular socket wrenches

- Heavy-duty socket wrenches with hexagonal openings, manufactured from a forged hexagon, drilled across the full length
- Transverse holes for drive bars 292
- Hexagonal body to allow work with open ended wrenches
- Chrome plated finish

Ø mm	a mm	b mm	L mm	code	1
6x7	9,5	10,7	110	U02900101	1
8x9	12,5	14	120	U02900102	1
10x11	15	16	130	U02900103	1
12x13	17,5	19	140	U02900104	1
14x15	20	21,5	150	U02900105	1
16x17	22,7	24	160	U02900107	1
18x19	25,2	26,5	170	U02900109	1
20x22	27,7	30,2	180	U02900110	1
21x23	29	31,2	185	U02900111	1
24x26	33	35,5	190	U02900112	1
27x29	37	39,5	200	U02900114	1
30x32	40,5	43	200	U02900116	1
36x41	49	55,5	240	U02900118	1



## 290 E/8

### Set of 8 tubular socket wrenches

- Supplied with drive bar 292/1
- Heavy-duty socket wrenches with hexagonal openings, manufactured from a forged hexagon, drilled across the full length
- Transverse holes for drive bar 292
- Hexagonal body to allow work with open ended wrenches
- Chrome plated finish

pcs	description	item/size
8	Double ended tubular socket wrenches/ 6x7-8x9-10x11-12x13-14x15-16x17-18x19-20x22	290 E
1	Drive bars	292/1

Kg	code	1
1,1	U02900281	1



## 290 E/12

### Set of 12 tubular socket wrenches

- Supplied with drive bars 292/1-2
- Heavy-duty socket wrenches with hexagonal openings, manufactured from a forged hexagon, drilled across the full length
- Transverse holes for drive bars 292
- Hexagonal body to allow work with open ended wrenches
- Chrome plated finish

pcs	description	item/size
12	Double ended tubular socket wrenches/ 6x7-8x9-10x11-12x13-14x15-16x17-18x19-20x22-21x23-24x26-27x29-30x32	290 E
2	Drive bars	292/1-2

Kg	code	1
3,3	U02900282	1



NEW

## 290 E/C14

### Set of 14 tubular socket wrenches

- Supplied in sheet steel case with drive bars 292/1-2
- Heavy-duty socket wrenches with hexagonal openings, manufactured from a forged hexagon, drilled across the full length
- Transverse holes for drive bars 292
- Hexagonal body to allow work with open ended wrenches

pcs	description	item/size
12	Double ended tubular socket wrenches/ 6x7-8x9-10x11-12x13-14x15-16x17-18x19-20x22-21x23-24x26-27x29-30x32	290 E
2	Drive bars	292/1-2
1	Bi-colour foam module (empty)	519 M 290E14V
1	Sheet steel box (empty) - size XL	612 XL

code	1
U02900187	1



## 290 E/R12

### Set of 12 tubular socket wrenches

- Supplied with metal holder and drive bars 292/1-2
- Heavy-duty socket wrenches with hexagonal openings, manufactured from a forged hexagon, drilled across the full length
- Transverse holes for drive bars 292
- Hexagonal body to allow work with open ended wrenches
- Chrome plated finish

pcs	description	item/size
13	Double ended tubular socket wrenches/ 6x7-8x9-10x11-12x13-14x15-16x17-18x19-20x22-21x23-24x26-27x29-30x32	290 E
1	Empty holder for tubular socket wrenches	290 E/RV13
2	Drive bars	292/1-2

Kg	code	1
4	U02900286	1

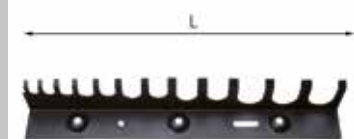

## 290 E/RV13

### Empty holder for tubular socket wrenches

- Enamelled sheet steel
- Supplied without screws
- For wrench set 290 E/R12

L mm	code	1
400	U02900200	1



## 291

UNI 6748 ISO 2236

### Double ended offset socket wrenches

- Heavy-duty wrenches, straight head with hexagonal opening and bent head with bihexagonal opening
- Hexagonal profiles on both sides up to size 9 mm
- Manufactured from a forged and drilled hexagon
- Transverse holes for drive bars 292
- Hexagonal body to allow work with open ended wrenches
- Chrome plated finish

Ø mm	a mm	L mm	code	
5,5	8,8	87	U02910000	1
6	9,5	87	U02910001	1
7	10,7	92	U02910002	1
8	12,5	97	U02910003	1
9	14	106	U02910004	1
10	15	113	U02910005	1
11	16	121	U02910006	1
12	17,5	131	U02910007	1
13	19	138	U02910008	1
14	20	146	U02910009	1
15	21,5	153	U02910010	1
16	22,7	159	U02910011	1
17	24	167	U02910012	1
18	25,2	171	U02910013	1
19	26,5	176	U02910014	1
22	30,2	199	U02910017	1
24	33	211	U02910019	1

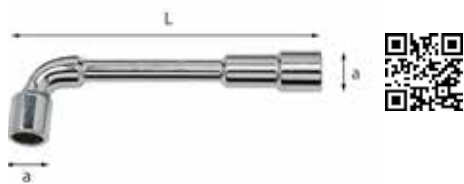

## 291 N

ISO 2236 ISO 691

### Double ended hollow offset socket wrenches

- Heavy-duty wrenches, deep straight head with hexagonal opening and bent head with bihexagonal opening
- Hexagonal profile on both sides up to size 9 mm
- Hollow profile for projecting screws or drive bars
- Chrome plated finish

Ø mm	a mm	L mm	code	
6	10	102	U02910104	5
7	11	106	U02910105	5
8	12,5	114	U02910106	5
9	13,5	122	U02910107	5
10	15	129	U02910108	5
11	16,5	136	U02910109	5
12	18	144	U02910110	5
13	19,5	152	U02910111	5
14	21	160	U02910112	5
15	22,5	169	U02910113	5
16	24	178	U02910114	5
17	25,5	187	U02910115	5
18	26,5	195	U02910116	5
19	28,5	204	U02910117	5
20	29,5	212	U02910118	5
21	30,5	221	U02910119	2
22	32	230	U02910120	2
23	33,5	240	U02910121	2
24	34,5	250	U02910122	2
25	36	260	U02910123	2
26	37	270	U02910124	2
27	38	280	U02910125	1
28	39,5	290	U02910126	1
30	42	310	U02910128	1
32	44,5	330	U02910130	1

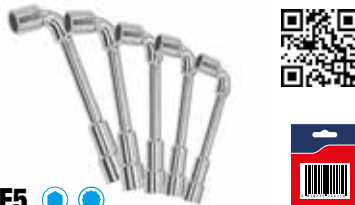

## 291 N/SE5

### Set of 5 hollow offset socket wrenches

pcs	description	item/size
5	Double ended hollow offset socket wrenches/8-10-13-17-19	291 N

kg	code	
1	U02910280	1



## 291 N/SE17

### Set of 17 hollow offset socket wrenches

pcs	description	item/size
17	Double ended hollow offset socket wrenches/ 6-7-8-9-10-11-12-13-14-15-16-17-18-19-20-21-22	291 N

kg	code	
3,9	U02910281	1



## 291 N/SE25

### Set of 25 hollow offset socket wrenches

pcs	description	item/size
25	Double ended hollow offset socket wrenches/ 6-7-8-9-10-11-12-13-14-15-16-17-18-19-20-21-22-23-24-25-26-27-28-30-32	291 N

kg	code	
10,9	U02910282	1

## 292

### Drive bars

- Model with different diameters
- For use in combination with tubular wrenches 288 N-290 E and socket wrenches 289N and 291
- Chrome plated finish

n°	Ø mm	L mm	code	
1	4÷23	220	U02920001	1
2	24÷32	300	U02920002	1
3	27÷41	350	U02920003	1

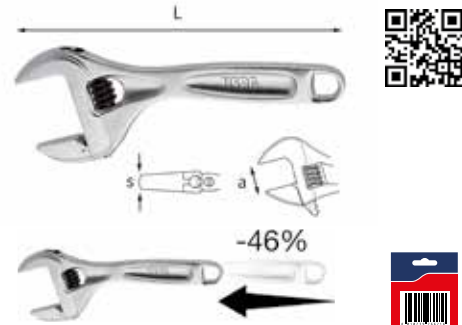

## 294 AC

ISO 6787

### Short adjustable wrench

- Length reduced of 46% compared to a standard wrench
- Same jaw opening of a 12" wrench
- Lightweight and compact for optimum accessibility
- Regulation by steel roll
- Scale in millimeters on the wrench head
- Chrome plated finish

L mm	s mm	a mm	code	
150	9,9	34 (1 11/32")	U02940010	1

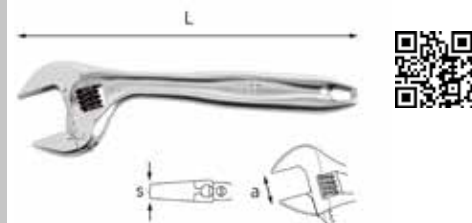

## 294 AD

ASME B107.100

### Adjustable wrenches with quick adjustment

- Quick adjustment by pulling back the roll
- Large capacity: opening +20% compared to the standard
- Double graduated scale: millimetres and inches
- Head angled at 22°
- Steel roll
- Hanging hole
- Chrome plated finish



L mm	s mm	a mm	code	
110 - 4"	9,4	17	U02940011	5
150 - 6"	11,4	23	U02940012	5
200 - 8"	14,2	33	U02940013	5
250 - 10"	16,3	38	U02940014	5
300 - 12"	18,5	41	U02940015	5
380 - 15"	20,4	50	U02940016	1
460 - 18"	22,6	63	U02940017	1



## D 294 AD

ASME B107.100

### Adjustable wrenches with quick adjustment

L mm	s mm	a mm	code	
150 - 6"	11,4	23	U02940012D	1
200 - 8"	14,5	33	U02940013D	1
250 - 10"	16,3	38	U02940014D	1
300 - 12"	18,5	41	U02940015D	1



## 294 AD/SE2

### Set of 2 adjustable wrenches with quick adjustment

pcs	description	item/size
1	Short adjustable wrench	294 AC/150
1	Adjustable wrenches with quick adjustment	294 AD/250

code	item/size
U02940030	1



## 294 AG

ASME B107.100

### Reversible adjustable wrenches with handle

- In the standard position it can drive a hexagonal profile
- By reversing the movable jaw, it can drive a round profile
- Large capacity: opening +20% compared to the standard
- Double graduated scale: millimetres and inches
- Ergonomic bimaterial handle
- Head angled at 22°
- Steel roll
- Hanging hole
- Chrome plated finish



L mm	s mm	a mm	code	item/size
200 - 8"	14,2	33	U02940023	1
250 - 10"	16,3	38	U02940024	1
300 - 12"	18,5	41	U02940025	1



## 297 N

ISO 691

### Double ended wrenches with single-jointed bihexagonal sockets

- Model with friction-spring to allow presetting of the sockets at the desired angle
- Chrome plated finish

Ø mm	L mm	code	item/size
6x7	189	U02970200	2
8x9	189	U02970201	2
10x11	195	U02970202	2
12x13	234	U02970204	2
14x15	238	U02970205	2
16x17	280	U02970206	2
18x19	286	U02970208	2
21x23	331	U02970210	2
22x24	333	U02970214	2



## 297 N/SE9

### Set of 9 double ended wrenches with single-jointed bihexagonal sockets

pcs	description	item/size
9	Double ended wrenches with single-jointed bihexagonal sockets /6x7-8x9-10x11-12x13-14x15-16x17-18x19-21x23-22x24	297 N

kg	code	item/size
1,5	U02970084	1



## 298

UNI 6750 ISO 2236

### Hexagonal socket spinners with grip

- Ergonomic three-material grip with soft covering, resistant to oils and chemicals
- Special Chrome Vanadium steel body
- Chrome plated finish

Ø mm	b mm	c mm	L mm	handle size	code	item/size
4	75	20	188	M3	U02980251	1
5	75	25	188	M3	U02980252	5
5,5	75	30	188	M3	U02980253	5
6	75	35	188	M3	U02980254	5
7	75	35	193	M3	U02980255	5
8	75	50	193	M3	U02980256	5
9	75	50	193	M3	U02980257	1
10	85	50	193	M3	U02980258	5
11	85	50	193	M4	U02980259	1
12	85	50	193	M4	U02980260	1
13	85	50	198	M4	U02980261	5



## D 298

UNI 6750 ISO 2236

### Hexagonal socket spinners with grip

Ø mm	b mm	c mm	L mm	code	item/size
5	75	25	188	U02980252D	1
5,5	75	30	188	U02980253D	1
6	75	35	188	U02980254D	1
7	75	35	193	U02980255D	1
8	75	50	193	U02980256D	1
10	85	50	198	U02980258D	1
13	85	50	188	U02980261D	1



## 298 SE11

### Set of 11 socket spinners with grip

pcs	description	item/size
11	Hexagonal socket spinners with grip / 4-5-5,5-6-7-8-9-10-11-12-13	298

kg	code	item/size
1,4	U02980290	1



## 298 RV8

### Empty holder for hexagonal socket spinners

- Enamelled sheet steel
- Supplied without screws
- For wrenches 298 - 298 SN - 299

L mm	code	item/size
265	U02980020	1

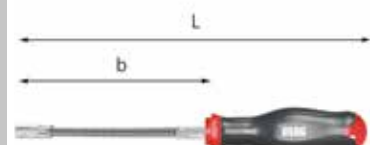

## 298 SN

### Flexible hexagonal socket spinners with grip

- Maximum permissible torsion 10 Nm
- Ergonomic three-material grip with soft covering, resistant to oils and chemicals
- Chrome plated finish

Ø mm	b mm	L mm	handle size	code	item/size
5,5	155	270	M4	U02980292	1
6	155	270	M4	U02980293	1
7	155	270	M4	U02980294	1
8	155	270	M4	U02980295	1
10	155	300	M4	U02980297	1
13	155	300	M4	U02980299	1



## 298 SN/SE4

### Set of 4 flexible hexagonal socket spinners with grip

pcs	description	item/size
4	Flexible hexagonal socket spinners with grip/7-8-10-13	298 SN

kg	code	item/size
1	U02980288	1

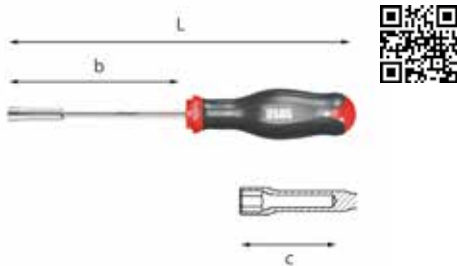

**299** ISO 2236 ISO 691

**Hexagonal socket spinners with grip**

- Deep hexagonal socket for working on projecting screws
- Ergonomic three-material grip with soft covering, resistant to oils and chemicals
- Special Chrome Vanadium steel body
- Chrome plated finish

Ø mm	b mm	c mm	L mm	handle size	code	
4	125	20	240	M3	U02990201	5
5	125	25	240	M3	U02990202	5
5,5	125	30	240	M3	U02990203	5
6	125	35	240	M3	U02990204	5
7	125	35	245	M3	U02990205	5
8	125	50	245	M3	U02990206	5
9	125	50	245	M3	U02990207	5
10	125	50	245	M4	U02990208	5
11	125	50	245	M4	U02990209	5
12	125	50	245	M4	U02990210	5
13	125	55	250	M4	U02990211	5
14	125	55	250	M4	U02990212	5



**299 SE4**

**Set of 4 socket spinners with grip**

pcs	description	item/size
4	Hexagonal socket spinners with grip/ 7-8-10-13	299

à gr	code	
720	U02990200	1



**299 SE12**

**Set of 12 socket spinners with grip**

pcs	description	item/size
12	Hexagonal socket spinners with grip/ 4-5-5,5-6-7-8-9-10-11-12-13-14	299

à Kg	code	
1,6	U02990281	1

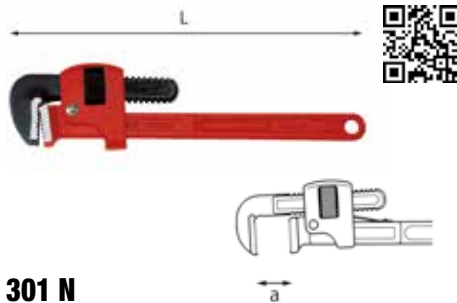

**301 N**

**Stillson-type pipe wrenches**

- Articulated cage with a double-spring device for gripping the pipe immediately, allowing quick resuming of the manoeuvre
- Body and movable jaw in Carbon steel
- Varnished execution

L mm	⊙ max	a mm	code	
250	1	34	U03010004	1
350	1 ½	49	U03010005	1
450	2	60	U03010006	1
600	2 ½	76	U03010007	1
900	3 ½	102	U03010008	1

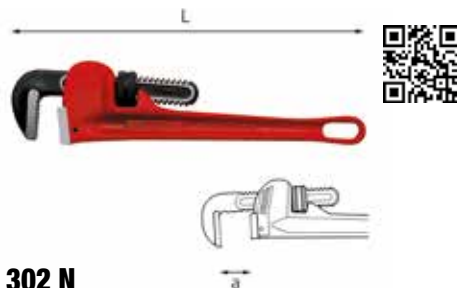

**302 N**

**American model pipe wrenches**

- Double-spring device for gripping the pipe immediately, allowing quick resuming of the manoeuvre
- Cast iron body
- Jaws in Carbon steel
- Varnished execution

L mm	⊙ max	a mm	code	
200	1	33	U03020003	1
250	1 ½	48	U03020004	1
350	2	60	U03020005	1
450	2 ½	73	U03020006	1
600	3	89	U03020007	1

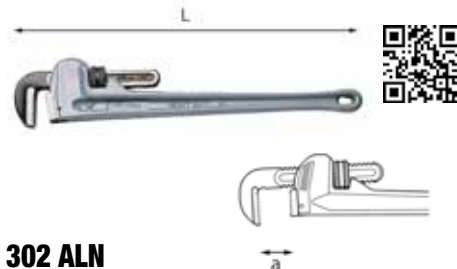

**302 ALN**

**American model pipe wrenches with Aluminium body**

- Double-spring device for gripping the pipe immediately, allowing quick resuming of the manoeuvre
- Jaws in Carbon steel
- Varnished execution

L mm	⊙ max	a mm	code	
350	2	60	U03020015	1
450	2 ½	73	U03020016	1
600	3	89	U03020017	1
900	5	141	U03020018	1



**302 AN**

**Spare mobile jaws**

- For pipe wrenches 302 N and 302 ALN

L mm	code	
200	U03020013Q	1
250	U03020014Q	1
350	U03020015Q	1
450	U03020016Q	1
600	U03020017Q	1
900	U03020018Q	1



**302 BN**

**Spare fix jaws**

- For pipe wrenches 302 N and 302 ALN

L mm	code	
200	U03020023Q	1
250	U03020024Q	1
350	U03020025Q	1
450	U03020026Q	1
600	U03020027Q	1
900	U03020028Q	1



**302 CN**

**Spare rollers**

- For pipe wrenches 302 N and 302 ALN

L mm	code	
200	U03020033Q	1
250	U03020034Q	1
350	U03020035Q	1
450	U03020036Q	1
600	U03020037Q	1
900	U03020038Q	1

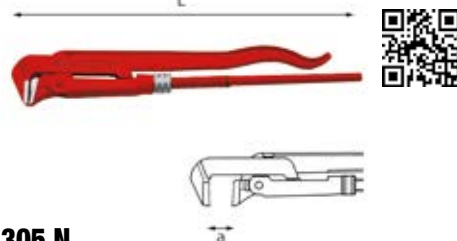

**305 N**

**Swedish model pipe wrenches with straight jaws at 90°**

- Chrome Vanadium steel
- Varnished execution

L mm	⊙ max	a mm	code	
330	1	40	U03050002	1
420	1 ½	55	U03050003	1
540	2	67	U03050004	1
690	3	103	U03050005	1

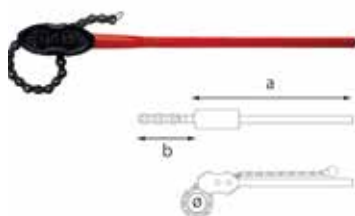

### 306 R

#### Chain wrenches

- Reversible jaws: longer life of the wrench
- Very strong model for heavy duty applications in chemical and oil industry, shipyards etc.
- Varnished execution

Ø mm	Ø"	a mm	b mm	kg	code	
13-76	1/4-2 1/2	695	420	4	U03060011	1
27-114	3/4-4	900	660	6	U03060012	1
34-165	1-6	1000	815	9	U03060013	1



### 306 RA

#### Spare chain

- For chain wrench 306 R

Ø mm	L mm	code	
13-76	420	U03060011Q	1
27-114	660	U03060012Q	1
34-165	815	U03060013Q	1



### 307 A/S7

#### Basin wrench

- For washbasins and mixers with nut-fixing
- Hollow shaft, 25 cm length
- Hollow end for hexagonal nuts 13 mm
- Supplied with adapters: 9,10,11,12,14,17 mm
- Varnished execution

capacity mm	kg	code	
9-10-11-12-13-14-17	400	U03070001	1



### 307 AR6

#### Set of 6 adapters

- For basin wrench 307 A
- 9-10-11-12-14-17 mm

kg	code	
100	U03070001Q	1



### 307 B

#### Reversible Sanicrom® basin wrench

- For nuts and connections on washbasins, bathtubs, sinks or bidets
- Direction of rotation reversed by pivoting the jaw without removing it from the tool
- Designed for tightening and loosening in difficult-to-reach locations
- Self-tightening jaw profile
- Varnished execution

capacity "	capacity mm	kg	code	
1 1/2	38	0,565	U03070002	1



### 308

#### Light-duty pipe wrenches with jaws bent to 90°

- Carbon steel
- Varnished execution

L mm	Ø max	a mm	code	
175	1	45	U03080001	5
225	1 1/2	60	U03080002	5
275	1 3/4	75	U03080003	5
315	2	85	U03080004	2
360	3	100	U03080005	2



### 309

#### Light-duty pipe wrenches with jaws bent to 45°

- Carbon steel
- Varnished execution

L mm	Ø max	a mm	code	
175	1	45	U03090001	5
225	1 1/2	60	U03090002	5
300	2	80	U03090003	2

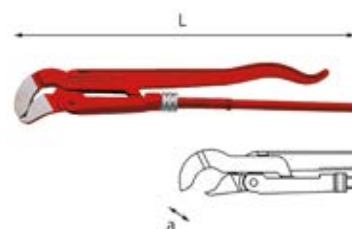

### 310 N

#### Swedish model pipe wrenches with thin, shaped jaws bent to 45°

- Chrome Vanadium steel
- Varnished execution

L mm	Ø max	a mm	code	
270	1/2	25	U03100001	1
340	1	40	U03100002	1
430	1 1/2	55	U03100003	1
550	2	67	U03100004	1
700	3	103	U03100005	1



### D 310 N

#### Swedish model pipe wrenches with thin, shaped jaws bent to 45°

L mm	Ø max	a mm	code	
430	1 1/2	55	U03100003D	1

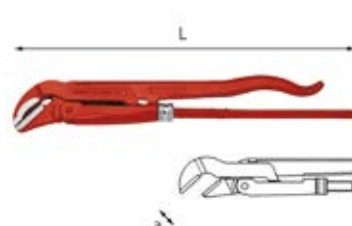

### 311 N

#### Swedish model pipe wrenches with thin, straight jaws bent to 45°

- Chrome Vanadium steel
- Varnished execution

L mm	Ø max	a mm	code	
270	1/2	25	U03110001	1
340	1	40	U03110002	1
430	1 1/2	55	U03110003	1
550	2	67	U03110004	1
700	3	103	U03110005	1



### 310 CN

#### Spare rollers

- For pipe wrenches 305 N, 310 N and 311 N

Ø max	code	
1/2	U03100011Q	1
1	U03100012Q	1
1 1/2	U03100013Q	1
2	U03100014Q	1
3	U03100015Q	1





**312**

**Light-duty chain wrench**

- Twin serrations in the jaw to permit work in both directions of rotation without removing the tool
- Chrome Vanadium steel lever
- Chain length: 420 mm (312 2÷4)
- Chain length: 600 mm (312 3÷5)
- Varnished execution

⊙ max	a mm	L mm	code	
2÷4	115	311,5	U03120011	1
3÷5	170	617	U03120012	1



**312 A**

**Spare chain**

- For light-duty chain wrench 312

L mm	code	
420	U03120101	1
600	U03120012Q	1



**312 B**

**Chain wrench, belt-type**

- Capacity: 0-165 mm
- Body in Aluminum alloy
- Nylon strap highly resistant
- Spare belt for n. 1: 138.S17
- Spare belt for n. 2: 138.S30
- Spare belt for n. 3: 138.S48
- Varnished execution

n°	⊙ max "	⊙ max mm	L mm	⊙ gr	code	
1	2	60	450	280	U03120005	1
2	4	125	750	290	U03120006	1
3	6	165	1500	310	U03120007	1



**313 A**

**Tube cutter for steel and stainless steel tubes**

- Quick replacement of the wheel, without any tool
- Internal system of rollers for a better cut and longer service life of wheels
- Steel and stainless steel can be cut with the same cutting wheel
- Forged steel body
- Enamelled finish
- Maximum tube thickness: 7 mm

⊙ mm	⊙ "	L max mm	L min mm	H mm	⊙ Kg	code	
10-60	1/8-2	460	387	128	2,1	U03130003	1

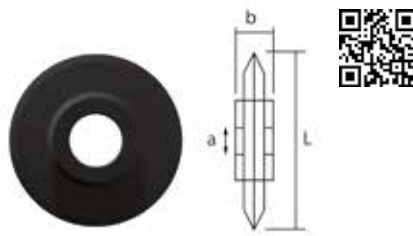

**313 AR**

**Spare cutting wheel for steel and stainless steel tubes**

- For tube cutters 313 A

a mm	b mm	L mm	⊙ gr	code	
9	19	31	30	U03130003Q	1



**313 B**

**Tube cutter for steel and stainless steel tubes**

- Quick replacement of the wheel, without any tool
- Internal system of rollers for a better cut and longer service life of wheels
- Steel and stainless steel can be cut with the same cutting wheel
- Forged steel body
- Enamelled finish
- Maximum tube thickness: 10 mm

⊙ mm	⊙ "	L mm	⊙ Kg	code	
60-114	2-4	630	7	U03130006	1

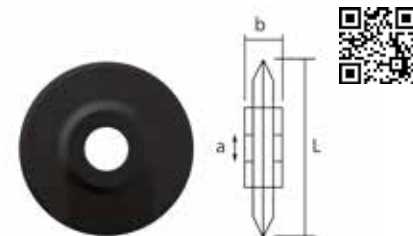

**313 BR**

**Spare cutting wheel for steel and stainless steel tubes**

- For tube cutters 313 B

a mm	b mm	L mm	⊙ gr	code	
9,7	28	41	30	U03130006Q	1



**314 A**

**Mini pipe cutter for Copper and light alloy tubes**

- Compact model with small working radius for use in narrow spaces
- Grooved guide-rollers for cutting flanged tubes
- Maximum thickness: 2 mm
- Light alloy body
- Enamelled finish

⊙ mm	⊙ "	L mm	H mm	⊙ gr	code	
3÷16	1/8-5/8	53	39	130	U03140010	1

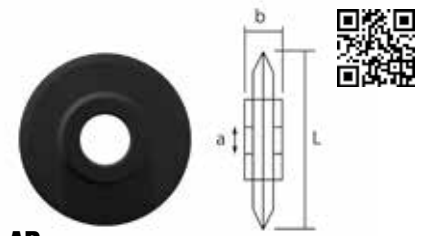

**314 AR**

**Spare cutting wheel for Copper and light alloy tubes (pack of 5 pcs.)**

- For tube cutters 314 A

a mm	b mm	L mm	⊙ gr	code	
4,8	3	18	30	U03140010Q	1



**314 B**

**Tube cutter for Copper and light alloy tubes**

- Compact model with small working radius for use in narrow spaces
- Grooved guide-rollers for cutting flanged tubes
- Quick replacement of the wheel, without any tool
- Ergonomic knob
- Light alloy body
- Enamelled finish
- Maximum tube thickness: 2 mm
- Supplied with two cutting wheels, one assembled and one in the knob

⊙ mm	⊙ "	L mm	H mm	⊙ gr	code	
3-35	1/8-1.3/8	74	51	220	U03140031	1

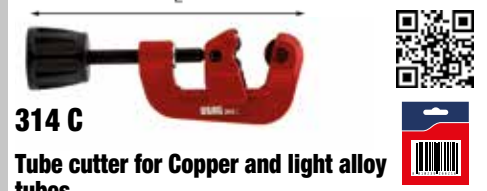

**314 C**

**Tube cutter for Copper and light alloy tubes**

- Grooved guide-rollers for cutting flanged tubes
- Threaded steel insert for fast sliding
- Quick replacement of the wheel, without any tool
- Ergonomic knob
- Light alloy body
- Enamelled finish
- Maximum tube thickness: 2 mm

⊙ mm	⊙ "	L max mm	L min mm	H mm	⊙ gr	code	
3-30	1/8-1/8	180	150	60	340	U03140032	1

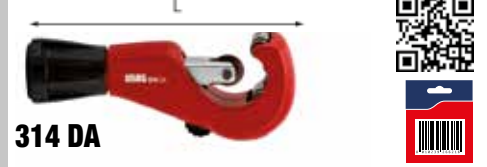

**314 DA**

**Tube cutter for Copper and light alloy tubes**

- Model with telescopic advance mechanism and uniform dimensions
- Four grooved guide-rollers for cutting flanged tubes
- Quick replacement of the wheel, without any tool
- Ergonomic knob
- Light alloy body
- Enamelled finish
- Maximum tube thickness: 2 mm
- Flaring blade incorporated
- Supplied with two cutting wheels, one assembled and one in the knob

⊙ mm	⊙ "	L mm	H mm	⊙ gr	code	
3-35	1/8-1.3/8	161	65	340	U03140033	1

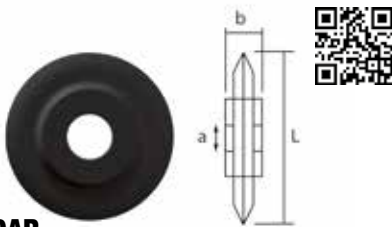

### 314 DAR

#### Spare cutting wheel for Copper and light alloy tubes

- For tube cutters 314 B, 314 C, 314 DA

a mm	b mm	L mm	á gr	code	
5	5	19	30	U03140033Q	1



### 314 DB

#### Tube cutter for stainless steel tubes

- Model with telescopic advance mechanism and uniform dimensions
- Four stainless steel guide-rollers with ball bearings
- Quick replacement of the wheel, without any tool
- Ergonomic knob
- Light alloy body
- Enamelled finish
- Maximum tube thickness: 2,5 mm
- Flaring blade incorporated
- Supplied with two cutting wheels, one assembled and one in the knob

Ø mm	Ø"	L max mm	L min mm	H mm	á gr	code	
3-35	1/8-1.3/8	161	65	340		U03140034	1

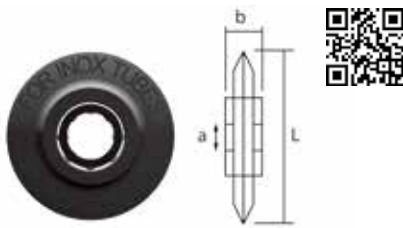

### 314 DBR

#### Spare cutting wheel for stainless steel tubes

- For tube cutters 314 DB
- Inside bearings for better blade rotation

a mm	b mm	L mm	á gr	code	
5	5	19	30	U03140034Q	1



### 314 FA

#### Tube cutter for Copper and light alloy tubes

- Rack-type model for rapid advance and return
- Four grooved guide-rollers for cutting flanged tubes
- Quick replacement of the wheel, without any tool
- Ergonomic knob
- Light alloy body
- Enamelled finish
- Maximum tube thickness: 2 mm
- Flaring blade incorporated
- Supplied with two cutting wheels, one assembled and one in the knob

Ø mm	Ø"	L max mm	L min mm	H mm	á gr	code	
6-76	1/4-3	334	244	102	890	U03140037	1

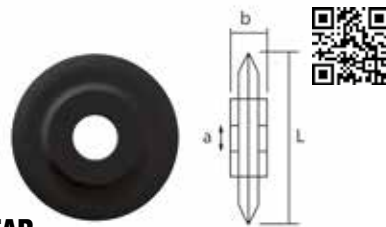

### 314 FAR

#### Spare cutting wheel for Copper and light alloy tubes

- For tube cutters 314 FA

a mm	b mm	L mm	á gr	code	
4,85	6,2	19	30	U03140037Q	1



### 314 FB

#### Tube cutter for stainless steel tubes

- Rack-type model for rapid advance and return
- Four stainless steel guide-rollers with ball bearings
- Quick replacement of the wheel, without any tool
- Ergonomic knob
- Light alloy body
- Enamelled finish
- Maximum tube thickness: 2,5 mm
- Flaring blade incorporated
- Supplied with two cutting wheels, one assembled and one in the knob

Ø mm	Ø"	L max mm	L min mm	H mm	á gr	code	
6-76	1/4-3	334	244	102	910	U03140038	1

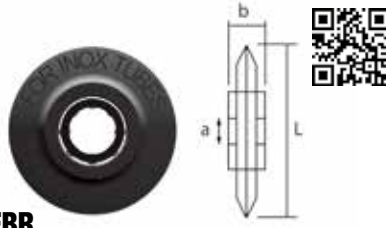

### 314 FBR

#### Spare cutting wheel for stainless steel tubes

- For tube cutters 314 FB
- Inside bearings for better blade rotation

a mm	L mm	b mm	á gr	code	
4,85	19	6,2	30	U03140038Q	1



### 314 FC

#### Tube cutter for plastic tubes

- Rack-type model for rapid advance and return
- Four guide-rollers for cutting flanged tubes
- Quick replacement of the wheel, without any tool
- Ergonomic knob
- Light alloy body
- Enamelled finish
- Maximum tube thickness: 8,6 mm
- Flaring blade incorporated
- Supplied with two cutting wheels, one assembled and one in the knob

Ø mm	Ø"	L max mm	L min mm	H mm	á gr	code	
6-76	1/4-3	334	244	100	890	U03140039	1

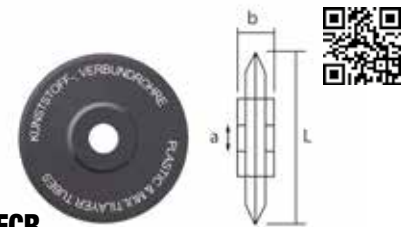

### 314 FCR

#### Spare cutting wheel for plastic tubes

- For tube cutters 314 FC

a mm	b mm	L mm	á gr	code	
4,85	6,2	30	30	U03140039Q	1



### 315

#### Flaring tool for Copper and light alloy tubes

- For creating 45° conical flared ends
- Cast iron body
- Die and cone in Carbon steel

capacity Ø mm	code	
4-6-8-10-12-14-16	U03150005	1



### 315 MP

#### Die in inches

- For flaring tool 315

capacity Ø mm	code	
3/16-1/4-5/16-3/8-7/16-1/2-5/8	U03150005Q	1



### 315 S

#### Deburrer - Calibrator

- For multilayer pipes
- Dual function: calibration and internal deburring
- Recalibrates the internal diameter of the tube after cutting
- Makes the internal deburring for more precise fitting
- It allows to work on 4 different diameters (16-20-26-32 mm)
- Steel body (95 Hrb)
- Plastic handle

Ø outside x thickness	á gr	code	
16x2-20x2-26x3-32x3	260	U03150100	1



### 316 C

#### Tube bending tools for Copper and light alloy

- For making bends up to 180°
- Steel die with graduations from 0° to 180°
- Steel levers
- Maximum thickness 1÷1,2 mm
- Ergonomic handles

Ø tube mm	L mm	radius mm	▲ gr	code	
6	225	14	360	U03160021	1
8	225	18	360	U03160022	1
10	317	25	450	U03160023	1
12	460	38	2000	U03160024	1
14	737	57	3000	U03160025	1
16	737	57	3000	U03160026	1



### 317 AM

#### Tube cutter for PEX and plastic tubes

- Blade with special shape and PTFE coating
- Automatic blade return
- Closure system with one hand

Ø tube mm	Ø"	LxPxH mm	code	
22	7/8	169x19x50	U03170001	1



### 317 AMR

#### Spare blade

code	
U03170001Q	1



### 317 BM

#### Tube cutter for plastic tubes and profiles

- For PVC, multilayer and PEX tubes
- Progressive cutting action with minimal effort
- Quick replacement of the blade without any tool
- Blade totally integrated in the body of the product
- Stainless steel blade with special shape and PTFE coating
- Blade return with one hand
- Ergonomic bimaterial handle

Ø mm	Ø"	LxPxH mm	code	
42	1 5/8	242x25x107	U03170010	1



### 317 BMR

#### Spare blade

code	
U03170010Q	1



### 317 C

#### Tube cutter for plastic tubes and profiles

- Rack-type model for an effortless progressive cutting action
- Suitable for quick cut of PVC, PP, PE, PER, ABS, PEHD tubes
- Blade treated for square cuts without burrs
- Light alloy body
- Enamelled finish

Ø mm	Ø"	▲ Kg	code	
63	2-2.1/2	1,2	U03170004	1



### 317 CR

#### Spare blade

▲ gr	code	
200	U03170003Q	1



### 317 EM

#### Tube cutter for PEX and plastic tubes

- Blade with special shape and PTFE coating
- 4 rollers with integrated bearings in the jaw to facilitate rotation of the tube during cutting
- 4-blades system integrated in the handle for cutting the corrugated pipe ducts (diameter 18-35 mm) without damaging the inner tube
- Automatic blade return
- Closure system with one hand
- Ergonomic bimaterial handle

Ø"	Ø tube mm	LxPxH mm	code	
1	26	189x28x65,5	U03170005	1



### 317 EMR

#### Spare blade

code	
U03170005Q	1



### 317 K

#### Tube cutters for plastic tubes

- For cutting PEX, PEHD, PVC, PER tubes
- Rack-type model for an effortless progressive cutting action
- Light alloy body
- Enamelled finish

Ø mm	Ø"	▲ gr	code	
35	1 3/8	200	U03170012	1



### 317 KR

#### Spare blade

▲ gr	code	
100	U03170012Q	1



### 321 F

#### Phase-testing screwdriver 110÷250V

- Grip and sheath thermoformed in one piece
- Finger protection integrated in the handle
- Steel blade with galvanized finish

axbxc mm	L mm	code	
0,6x3x65	142	U03210005	5



### D 321 F

#### Phase-testing screwdriver 110÷250V

axbxc mm	L mm	code	
0,6x3x65	142	U03210005D	1



### 321 FL

#### Phase-testing screwdriver 90÷480V, long model

- Grip and sheath thermoformed in one piece
- Finger protection integrated in the handle
- Steel blade with galvanized finish

axbxc mm	L mm	code	
0,8x3,5x100	190	U03210006	1

1000 V 



PAGE  
**44**



**USAG SLIM**

**091**

## 1000V insulation

- Special Silicon Manganese, Molybdenum steel blade
- Insulated ergonomic three-material grip
- Silicon Chrome steel tip for maximum torsion resistance
- Thin blade for better accessibility
- Colour code and pictogram for easy identification of the shape



 YouTube



PAGE  
**133**



**324**

## Top performances

- Special Chrome, Silicon, Vanadium steel blade for the maximum mechanical resistance
- Ergonomic three-material grip
- Zinc-plated tip: perfect geometry and anti corrosion treatment
- Thin blade for better accessibility
- Colour code and pictogram for easy identification of the shape



























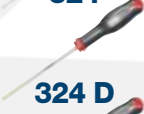

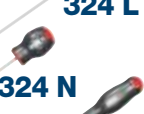







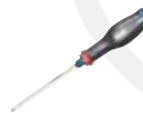

PAGE  
**132**



**322**

## Quality and performances

- Chrome, Vanadium, Molybdenum steel blade
- Anti-slip ergonomic bimaterial grip
- Chrome-plated anticorrosion tip
- Interior in natural polypropylene
- Colour code and pictogram for easy identification of the shape

	 <b>SLOT-HEAD</b>	 <b>PHILLIPS</b>	 <b>COMBI</b> <small>SLOT-HEAD/PHILLIPS®</small>	 <b>POZIDRIV®</b>	 <b>COMBI</b> <small>SLOT-HEAD/POZIDRIV®</small>	 <b>TORX®</b>	 <b>TORX®</b> <small>TAMPER RESISTANT</small>
<b>091</b>	 <b>091</b>  <b>091 D</b>	 <b>091 PH</b>  <b>091 DPH</b>	 <b>091 DPHB</b>	 <b>091 PZ</b>	 <b>091 DPZB</b>		
<b>324</b>	 <b>324</b>  <b>324 D</b>  <b>324 E</b>  <b>324 L</b>  <b>324 N</b>  <b>324 H</b>	 <b>324 PH</b>  <b>324 EPH</b>  <b>324 LPH</b>  <b>324 NPH</b>  <b>324 HPH</b>		 <b>324 PZ</b>  <b>324 EPZ</b>		 <b>324 TX</b>  <b>324 LTX</b>	 <b>324 STX</b>
<b>322</b>	 <b>322</b>  <b>322 N</b>  <b>322 R</b>	 <b>322 PH</b>  <b>322 NPH</b>  <b>322 R</b>		 <b>322 PZ</b>		 <b>322 TX</b>	 <b>322 STX</b>

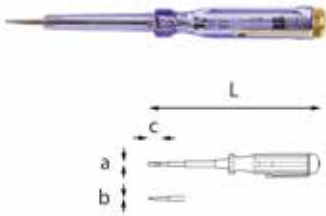

### 322 FB

#### Phase-testing screwdriver 110÷380 Volts

- Model with grip and sheath thermoformed in one piece
- Silicon Chrome Vanadium steel blade

axbxc mm	L mm	code	
3x0,5x18	141	U03220401	1

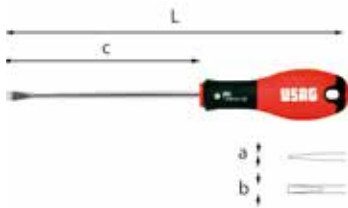

### 322

ISO 2380

#### Screwdrivers for slot-head screws

- Ergonomic bimaterial grip
- Chrome Vanadium steel blade
- Chrome plated finish with sandblasted tip
- Model with hexagonal drive for size 1,6x10x200 and 2x12x250
- Milled blade for size 0,4x2,5x75 - 0,4x2x50 - 0,5x3x75 - 0,5x3x100 - 0,6x3,5x75

axbxc mm	L mm	handle size	code	
0,4x2x50	148	M1	U03220025	5
0,4x2,5x75	173	M1	U03220005	5
0,5x3x75	173	M1	U03220006	5
0,5x3x100	198	M1	U03220007	5
0,6x3,5x75	173	M2	U03220028	5
0,8x4x100	202	M2	U03220008	5
0,8x4x125	227	M3	U03220009	5
1x5,5x100	205	M2	U03220011	5
1x5,5x125	230	M3	U03220012	5
1,2x6,5x125	241	M4	U03220014	5
1,2x6,5x150	266	M4	U03220015	5
1,6x8x175	291	M4	U03220017	5
1,6x10x200	275	M4	U03220023	5
2x12x250	366	M4	U03220024	5

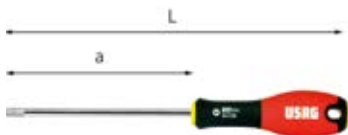

### 322 PH

ISO 8764

#### Screwdrivers for PHILLIPS® screws

- Ergonomic bimaterial grip
- Chrome Vanadium steel blade
- Chrome plated finish with sandblasted tip
- Model with hexagonal drive for size 3x150

n°xa	L mm	handle size	code	
0x75	177	M2	U03220039	5
1x100	205	M3	U03220041	5
2x125	230	M3	U03220043	5
3x150	266	M4	U03220047	5

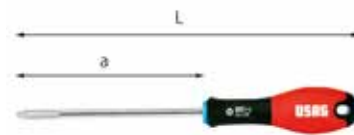

### 322 PZ

ISO 8764

#### Screwdrivers for POZIDRIV®-SUPADRIV® screws

- Ergonomic bimaterial grip
- Chrome Vanadium steel blade
- Chrome plated finish with sandblasted tip

n°xa	L mm	handle size	code	
0x75	177	M2	U03220056	5
1x100	205	M3	U03220057	5
2x125	230	M3	U03220058	5

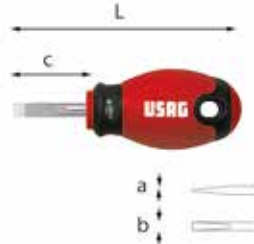

### 322 N

ISO 2380

#### Screwdrivers for slot-head screws

- Stubby model
- Ergonomic bimaterial grip
- Chrome Vanadium steel blade
- Chrome plated finish with sandblasted tip

axbxc mm	L mm	handle size	code	
0,8x4x30	90	M0	U03220063	5
1x5,5x30	90	M1	U03220064	5
1,2x6,5x30	90	M2	U03220065	5



### 322 NPH

ISO 2380

#### Screwdrivers for PHILLIPS® screws

- Stubby model
- Ergonomic bimaterial grip
- Chrome Vanadium steel blade
- Chrome plated finish with sandblasted tip

n°xa	L mm	handle size	code	
1x30	90	M0	U03220068	5
2x30	90	M2	U03220069	5

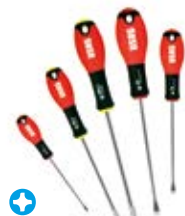

### 322 SH5

#### Set of 5 screwdrivers for slot-head and PHILLIPS® screws

- Ergonomic bimaterial grip
- Chrome Vanadium steel blade
- Chrome plated finish with sandblasted tip
- Milled blade for size 0,6x3,5x75

pcs	description	item/size
3	Screwdrivers for slot-head screws / 0,8x4x100-1x5,5x100-0,6x3,5x75	322
2	Screwdrivers for PHILLIPS® screws / 1x100-2x125	322 PH

g	code	
450	U03220253	1

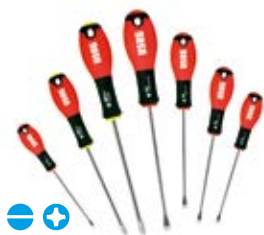

### 322 SH7

#### Set of 7 screwdrivers for slot-head and PHILLIPS® screws

- Ergonomic bimaterial grip
- Chrome Vanadium steel blade
- Chrome plated finish with sandblasted tip
- Milled blade for size 0,4x2x50 - 0,5x3x75

pcs	description	item/size
5	Screwdrivers for slot-head screws / 0,4x2x50-0,5x3x75-0,8x4x100-1,5x100-1,2x6,5x150	322
2	Screwdrivers for PHILLIPS® screws / 1x100-2x125	322 PH

g	code	
600	U03220254	1



### 322 SH10

#### Set of 10 screwdrivers for slot-head, PHILLIPS® and POZIDRIV® screws

- Ergonomic bimaterial grip
- Chrome Vanadium steel blade
- Chrome plated finish with sandblasted tip
- Milled blade for size 0,4x2x50 - 0,5x3x75

pcs	description	item/size
5	Screwdrivers for slot-head screws / 0,4x2x50-0,5x3x75-0,8x4x100-1x5,5x100-1,2x6,5x150	322
3	Screwdrivers for PHILLIPS® screws / 0x75-1x100-2x125	322 PH
2	Screwdrivers for POZIDRIV®-SUPADRIV® screws/1x100-2x125	322 PZ

g	code	
800	U03220255	1

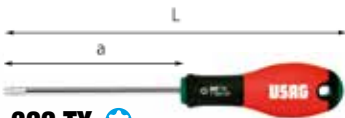

### 322 TX

#### Screwdrivers for TORX® screws

- Ergonomic bimaterial grip
- Molybdenum Vanadium steel blade
- Chrome plated finish with sandblasted tip

n°xa	L mm	handle size	code	
T6x50	148	M1	U03220071	5
T7x50	148	M1	U03220072	5
T8x50	148	M1	U03220073	5
T9x75	173	M1	U03220074	5
T10x75	177	M2	U03220075	5
T15x75	177	M2	U03220076	5
T20x100	202	M2	U03220077	5
T25x100	205	M3	U03220078	5
T27x100	205	M3	U03220079	1
T30x125	241	M4	U03220080	1
T40x125	241	M4	U03220081	1



### 322 TX/S11

#### Set of 11 screwdrivers for TORX® screws

pcs	description	item/size
11	Screwdrivers for TORX® screws/ T6x50-T7x50-T8x50-T9x50-T10x75- T15x75-T20x100-T25x100-T27x100- T30x125-T40x150	322 TX

gr	code	
900	U03220266	1



### 322 STX

#### Screwdrivers for TORX® Tamper Resistant screws

- Ergonomic bimaterial grip
- Molybdenum Vanadium steel blade
- Chrome plated finish with sandblasted tip

n°xa	L mm	handle size	code	
T10x75	175	M2	U03220086	5
T15x75	185	M2	U03220087	5

### 322 STX

n°xa	L mm	handle size	code	
T20x100	210	M2	U03220088	5
T25x100	210	M3	U03220089	5
T27x100	230	M3	U03220090	1
T30x125	230	M4	U03220091	1
T40x125	250	M4	U03220092	1



### 322 STX/S7

#### Set of 7 screwdrivers for TORX® Tamper Resistant screws

pcs	description	item/size
7	Screwdrivers for TORX® Tamper Resistant screws /T10x75-T15x75-T20x100-T25x100-T27x100-T30x125-T40x150	322 STX

gr	code	
600	U03220263	1



### 322 R

ISO 2380 ISO 8764

#### Reversible screwdriver for slot-head and PHILLIPS® screws

- Ergonomic bimaterial grip
- Chrome Vanadium steel blade
- Chrome plated finish with sandblasted tip

axbxc mm	n°xc	L mm	code	
1x6x75	2x75	200	U03220097	1



### 323 RV

#### Empty holders for screwdrivers

- For screwdrivers 322-324
- Enamelled sheet steel
- Supplied without screws

n°	L mm	code	
7	205	U03230511Q	1
10	295	U03230512Q	1
13	390	U03230513Q	1

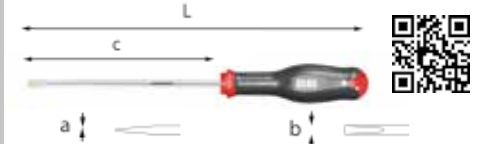

### 324

ISO 2380

#### Screwdrivers for slot-head screws

- Zinc-plated tip for high resistance to wear and corrosion
- Chrome Silicon Vanadium steel blade for excellent resistance to flexion
- Ergonomic three-material grip with soft coating, resistant to oils and chemicals
- Colour code on the handle for quick identification of the different shapes

axbxc mm	L mm	handle size	code	
0,5x3x75	169	M0	U03240401	5
0,5x3x100	194	M0	U03240402	5
0,8x4x100	204	M1	U03240403	5
0,8x4x125	229	M1	U03240404	5
0,8x4x150	254	M1	U03240405	5
1x5,5x100	209	M2	U03240406	5
1x5,5x125	234	M2	U03240407	5
1x5,5x150	259	M2	U03240408	5
1,2x6,5x125	245	M3	U03240409	5
1,2x6,5x150	270	M3	U03240410	5
1,2x8x200	325	M4	U03240411	5
1,6x10x200	325	M4	U03240412	5



### D 324

ISO 2380

#### Screwdrivers for slot-head screws

axbxc mm	L mm	code	
0,5x3x75	169	U03240401D	1
0,8x4x100	204	U03240403D	1
1x5,5x125	234	U03240407D	1
1x5,5x150	259	U03240408D	1
1,2x6,5x150	270	U03240410D	1
1,2x8x200	325	U03240411D	1



# 324

Screwdriver



YouTube

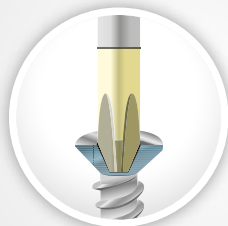

**Top performance tip**  
Silicon Chrome Vanadium steel  
for exceptional mechanical strength.

Zinc-plated tip: perfect geometry and anti-corrosion treatment.



**Ergonomic three-material grip**

Soft grip covering, resistant  
to oil and chemicals.



### 324 SE6

#### Set of 6 screwdrivers for slot-head screws

pcs	description	item/size
3	Screwdrivers for slot-head screws / 0,8x4x100-1x5,5x125-1,2x6,5x150	324
3	Screwdrivers for slot-head screws / 0,4x2,5x50-0,5x3x75-0,6x3,5x100	324 D

gr	code	
460	U03240652	1

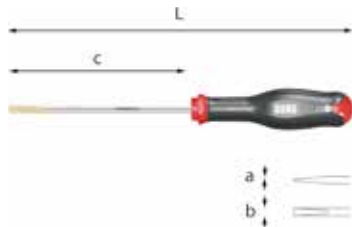

### 324 D

ISO 2380

#### Screwdrivers for slot-head screws

- For driving recessed studs or screws
- Zinc-plated tip for high resistance to wear and corrosion
- Chrome Silicon Vanadium steel blade for excellent resistance to flexion
- Ergonomic three-material grip with soft coating, resistant to oils and chemicals
- Colour code on the handle for quick identification of the different shapes

axbxc mm	L mm	handle size	code	
0,4x2x75	169	M0	U03240425	5
0,4x2,5x50	144	M0	U03240426	5
0,5x3x75	169	M0	U03240427	5
0,6x3,5x100	204	M1	U03240428	5
0,8x4x100	204	M1	U03240429	5
0,8x4x150	254	M1	U03240430	5
1x5,5x125	234	M2	U03240431	5
1x5,5x150	259	M2	U03240432	5
1,2x6,5x150	270	M3	U03240433	5



### D 324 D

ISO 2380

#### Screwdrivers for slot-head screws

axbxc mm	L mm	code	
0,4x2,5x50	144	U03240426D	1
0,5x3x75	169	U03240427D	1
0,6x3,5x100	204	U03240428D	1
0,8x4x100	204	U03240429D	1
1x5,5x125	234	U03240431D	1
1,2x6,5x150	270	U03240433D	1

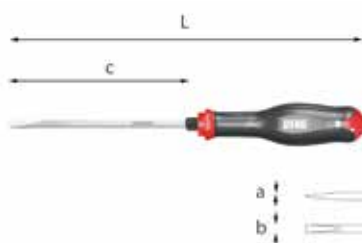

### 324 E

ISO 2380

#### Screwdrivers for slot-head screws

- Model with hexagonal drive and hexagonal blade for powerful tightening, also with a wrench
- Zinc-plated tip for high resistance to wear and corrosion
- Chrome Silicon Vanadium steel blade for excellent resistance to flexion
- Ergonomic three-material grip with soft coating, resistant to oils and chemicals
- Colour code on the handle for quick identification of the different shapes

axbxc mm	L mm	Ø mm	handle size	code	
1x5,5x125	234	8	M2	U03240505	1
1,2x6,5x150	270	10	M3	U03240506	1
1,2x8x175	300	11	M4	U03240507	1
1,6x8x175	300	12	M4	U03240508	1
1,6x10x175	300	14	M4	U03240509	1
2x12x250	375	14	M4	U03240510	1



### D 324 E

ISO 2380

#### Screwdrivers for slot-head screws

axbxc mm	L mm	Ø mm	code	
1,6x8x175	300	12	U03240508D	1
2x12x250	375	14	U03240510D	1

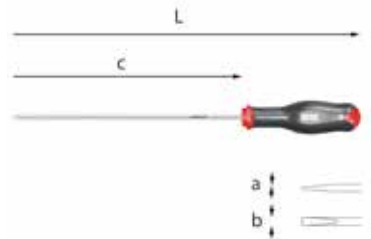

### 324 L

ISO 2380

#### Screwdrivers for slot-head screws

- Model with long blade
- Zinc-plated tip for high resistance to wear and corrosion
- Chrome Silicon Vanadium steel blade for excellent resistance to flexion
- Ergonomic three-material grip with soft coating, resistant to oils and chemicals
- Colour code on the handle for quick identification of the different shapes

axbxc mm	L mm	handle size	code	
0,6x3,5x250	354	M1	U03240419	5
0,8x4x300	404	M1	U03240420	5
1x5,5x300	409	M2	U03240421	5



### D 324 L

ISO 2380

#### Screwdrivers for slot-head screws

axbxc mm	L mm	code	
0,8x4x300	404	U03240420D	1



### 324 L/SH5

ISO 2380

#### Set of 5 screwdrivers for slot-head and PHILLIPS® screws

pcs	description	item/size
3	Screwdrivers for slot-head screws / 0,6x3,5x250-0,8x4x300-1x5,5x300	324 L
2	Screwdrivers for PHILLIPS® screws / 1x250-2x250	324 LPH

code	
U03240422	1

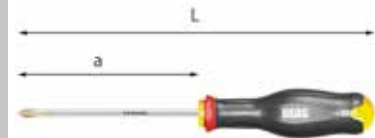

### 324 PH

ISO 8764

#### Screwdrivers for PHILLIPS® screws

- Zinc-plated tip for high resistance to wear and corrosion
- Chrome Silicon Vanadium steel blade for excellent resistance to flexion
- Ergonomic three-material grip with soft coating, resistant to oils and chemicals
- Colour code on the handle for quick identification of the different shapes

n°xa	L mm	handle size	code	
0x75	179	M1	U03240439	5
1x75	184	M2	U03240440	5
1x100	209	M2	U03240441	5
2x100	220	M3	U03240442	5
2x125	245	M3	U03240443	5
3x150	275	M4	U03240444	5
4x200	325	M4	U03240445	1



### D 324 PH

ISO 8764

#### Screwdrivers for PHILLIPS® screws

n°xa	L mm	code	
0x75	179	U03240439D	1
1x75	184	U03240440D	1
1x100	209	U03240441D	1
2x100	220	U03240442D	1
3x150	275	U03240444D	1



## 324 PH/SE4

### Set of 4 screwdrivers for PHILLIPS® screws

pcs	description	item/size
4	Screwdrivers for PHILLIPS® screws / 0x75-1x75-2x100-3x150	324 PH

n°xa	L mm	code	img
530	U03240668	1	



## 324 EPH

ISO 8764

### Screwdrivers for PHILLIPS® screws

- Model with hexagonal drive and hexagonal blade for powerful tightening, also with a wrench
- Zinc-plated tip for high resistance to wear and corrosion
- Chrome Silicon Vanadium steel blade for excellent resistance to flexion
- Ergonomic three-material grip with soft coating, resistant to oils and chemicals
- Colour code on the handle for quick identification of the different shapes

n°xa	L mm	Ø mm	handle size	code	img
1x100	209	8	M2	U03240513	1
2x125	245	10	M3	U03240514	1
3x150	275	12	M4	U03240515	1
4x200	325	14	M4	U03240516	1



## D 324 EPH

ISO 8764

### Screwdrivers for PHILLIPS® screws

n°xa	L mm	Ø mm	code	img
3x150	275	12	U03240515D	1



## 324 LPH

ISO 8764

### Screwdrivers for PHILLIPS® screws

- Model with long blade
- Zinc-plated tip for high resistance to wear and corrosion
- Chrome Silicon Vanadium steel blade for excellent resistance to flexion
- Ergonomic three-material grip with soft coating, resistant to oils and chemicals
- Colour code on the handle for quick identification of the different shapes

n°xa	L mm	handle size	code	img
1x250	359	M2	U03240450	5
2x250	370	M3	U03240451	5
2x400	520	M3	U03240452	1



## D 324 DPH

ISO 8764

### Screwdrivers for PHILLIPS® screws

n°xa	L mm	code	img
1x250	359	U03240450D	1
2x250	370	U03240451D	1



## 324 PZ

ISO 8764

### Screwdrivers for POZIDRIV®-SUPADRIV® screws

- Zinc-plated tip for high resistance to wear and corrosion
- Chrome Silicon Vanadium steel blade for excellent resistance to flexion
- Ergonomic three-material grip with soft coating, resistant to oils and chemicals
- Colour code on the handle for quick identification of the different shapes

n°xa	L mm	handle size	code	img
0x75	179	M1	U03240456	5
1x75	184	M2	U03240457	5
2x100	220	M3	U03240458	5
3x150	275	M4	U03240459	1



## D 324 PZ

ISO 8764

### Screwdrivers for POZIDRIV®-SUPADRIV® screws

n°xa	L mm	code	img
0x75	179	U03240456D	1
1x75	184	U03240457D	1
2x100	220	U03240458D	1
3x150	275	U03240459D	1

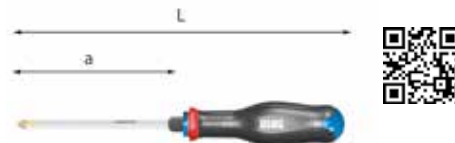

## 324 EPZ

ISO 8764

### Screwdrivers for POZIDRIV®-SUPADRIV® screws

- Model with hexagonal drive and hexagonal blade for powerful tightening, also with a wrench
- For driving recessed studs or screws
- Zinc-plated tip for high resistance to wear and corrosion
- Chrome Silicon Vanadium steel blade for excellent resistance to flexion
- Ergonomic three-material grip with soft coating, resistant to oils and chemicals
- Colour code on the handle for quick identification of the different shapes

n°xa	L mm	Ø mm	handle size	code	img
2x125	245	10	M3	U03240520	1
3x150	275	12	M4	U03240521	1
4x200	325	14	M4	U03240522	1

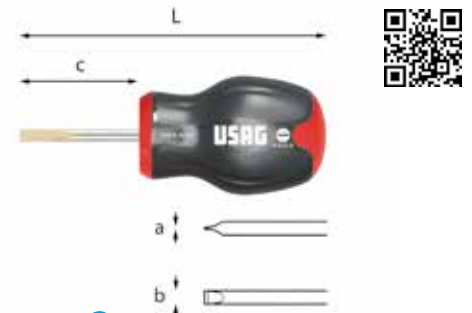

## 324 N

ISO 2380

### Screwdrivers for slot-head screws

- Stubby model
- Zinc-plated tip for high resistance to wear and corrosion
- Chrome Silicon Vanadium steel blade for excellent resistance to flexion
- Ergonomic three-material grip with soft coating, resistant to oils and chemicals
- Colour code on the handle for quick identification of the different shapes

axbxc mm	L mm	handle size	code	img
0,8x4x35	91	M0	U03240463	5
1x5,5x35	91	M1	U03240464	5
1,2x6,5x35	91	M2	U03240465	5



## D 324 N

ISO 2380

### Screwdrivers for slot-head screws

axbxc mm	L mm	code	img
0,8x4x35	91	U03240463D	1
1x5,5x35	91	U03240464D	1
1,2x6,5x35	91	U03240465D	1



## 324 NPH

ISO 8764

### Screwdrivers for PHILLIPS® screws

- Stubby model
- Zinc-plated tip for high resistance to wear and corrosion
- Chrome Silicon Vanadium steel blade for excellent resistance to flexion
- Ergonomic three-material grip with soft coating, resistant to oils and chemicals
- Colour code on the handle for quick identification of the different shapes

n°xa	L mm	handle size	code	img
1x35	91	M0	U03240468	5
2x35	91	M2	U03240469	5



## D 324 NPH

ISO 8764

### Screwdrivers for PHILLIPS® screws

n°xa	L mm	code	img
1x35	91	U03240468D	1
2x35	91	U03240469D	1



### 324 SH5

#### Set of 5 screwdrivers for slot-head and PHILLIPS® screws

pcs	description	item/size
3	Screwdrivers for slot-head screws / 0,5x3x75-0,8x4x100-1x5,5x125	324
2	Screwdrivers for PHILLIPS® screws / 1x75-2x100	324 PH

à gr	code	🔗
440	U03240645	1



### 324 SH8

#### Set of 8 screwdrivers for slot-head and PHILLIPS® screws

pcs	description	item/size
4	Screwdrivers for slot-head screws / 0,5x3x75-0,8x4x100-1x5,5x125-1,2x6,5x150	324
1	Screwdrivers for slot-head screws / 0,4x2,5x50	324 D
3	Screwdrivers for PHILLIPS® screws / 0x75-1x75-2x100	324 PH

à gr	code	🔗
640	U03240650	1



### 324 SH10

#### Set of 10 screwdrivers for slot-head and PHILLIPS® screws

pcs	description	item/size
3	Screwdrivers for slot-head screws / 0,8x4x100-1x5,5x125-1,2x6,5x150	324
3	Screwdrivers for slot-head screws / 0,4x2,5x50-0,5x3x75-0,6x3,5x100	324 D
4	Screwdrivers for PHILLIPS® screws / 0x75-1x75-2x100-3x150	324 PH

à gr	code	🔗
890	U03240655	1



### 324 SH12

#### Set of 12 screwdrivers for slot-head, PHILLIPS® and POZIDRIV® - SUPADRIV® screws

pcs	description	item/size
4	Screwdrivers for slot-head screws / 0,5x3x75-0,8x4x100-1x5,5x125-1,2x6,5x150	324
1	Screwdrivers for slot-head screws / 0,4x2,5x50	324 D
1	Screwdrivers for slot-head screws / 1x5,5x35	324 N
1	Screwdrivers for PHILLIPS® screws / 2x35	324 NPH
3	Screwdrivers for PHILLIPS® screws / 0x75-1x75-2x100	324 PH
2	Screwdrivers for POZIDRIV® - SUPADRIV® screws / 1x75-2x100	324 PZ

à gr	code	🔗
950	U03240651	1

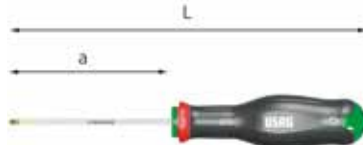

### 324 TX

#### Screwdrivers for TORX® screws

- Zinc-plated tip for high resistance to wear and corrosion
- TORX® profile optimized to adapt perfectly to the screw and increase torque transmission
- Chrome Silicon Vanadium steel blade for excellent resistance to flexion
- Ergonomic three-material grip with soft coating, resistant to oils and chemicals
- Colour code on the handle for quick identification of the different shapes

n°xa	L mm	handle size	code	🔗
T6x50	145	M0	U03240471	5
T7x50	145	M0	U03240472	5
T8x50	145	M0	U03240473	5
T9x75	170	M0	U03240474	5
T10x75	179	M1	U03240475	5
T15x75	184	M2	U03240476	5
T20x100	220	M3	U03240477	5
T25x100	220	M3	U03240478	5
T27x100	220	M3	U03240479	1
T30x125	245	M3	U03240480	1
T40x150	275	M4	U03240481	1



### D 324 TX

#### Screwdrivers for TORX® screws

n°xa	L mm	code	🔗
T6x50	145	U03240471D	1
T7x50	145	U03240472D	1
T8x50	145	U03240473D	1
T9x75	170	U03240474D	1



### 324 TX/S7

#### Set of 7 screwdrivers for TORX® screws

pcs	description	item/size
7	Screwdrivers for TORX® screws / T10x75-T15x75-T20x100-T25x100-T27x100-T30x125-T40x150	324 TX

à gr	code	🔗
810	U03240664	1



### 324 TX/S11

#### Set of 11 screwdrivers for TORX® screws

pcs	description	item/size
11	Screwdrivers for TORX® screws / T6x50-T7x50-T8x50-T9x50-T10x75-T15x75-T20x100-T25x100-T27x100-T30x125-T40x150	324 TX

à gr	code	🔗
920	U03240666	1

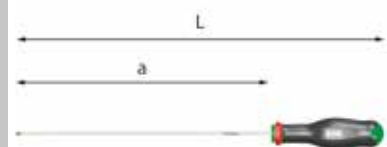

### 324 LTX

#### Screwdrivers for TORX® screws, long blade

- Model with extra-long blade
- Ideal for bodywork operations
- Zinc-plated tip for high resistance to wear and corrosion
- TORX® profile optimized to adapt perfectly to the screw and increase torque transmission
- Chrome Silicon Vanadium steel blade for excellent resistance to flexion
- Ergonomic three-material grip with soft coating, resistant to oils and chemicals
- Colour code on the handle for quick identification of the different shapes

n°xa	L mm	handle size	code	🔗
T20x275	400	M3	U03240495	1
T25x275	400	M3	U03240496	1
T27x275	400	M3	U03240497	1
T30x275	400	M3	U03240498	1
T40x275	400	M4	U03240499	1



### 324 LTX/SH5

#### Set of 5 long blade screwdrivers for TORX® screws

pcs	description	item/size
5	Screwdrivers for TORX® screws, long blade/ T20-T25-T27-T30-T40	324 LTX

code	item/size
U03240500	1

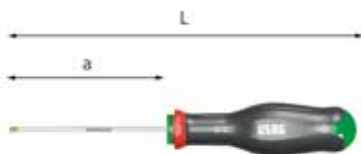

### 324 STX

#### Screwdrivers for TORX® Tamper Resistant screws

- For safety screws
- Zinc-plated tip for high resistance to wear and corrosion
- Chrome Silicon Vanadium steel blade for excellent resistance to flexion
- Ergonomic three-material grip with soft coating, resistant to oils and chemicals
- Colour code on the handle for quick identification of the different shapes

n°xa	L mm	handle size	code	item/size
T10x75	179	M1	U03240486	5
T15x75	184	M2	U03240487	5
T20x100	220	M3	U03240488	5
T25x100	220	M3	U03240489	5
T27x100	220	M3	U03240490	1
T30x125	245	M3	U03240491	1
T40x150	275	M4	U03240492	1



### D 324 STX

#### Screwdrivers for TORX® Tamper Resistant screws

n°xa	L mm	code	item/size
T10x75	179	U03240486D	1
T15x75	184	U03240487D	1
T20x100	220	U03240488D	1
T25x100	220	U03240489D	1
T27x100	220	U03240490D	1
T30x125	245	U03240491D	1
T40x150	275	U03240492D	1



### 324 STX/S7

#### Set of 7 screwdrivers for TORX® Tamper Resistant screws

pcs	description	item/size
7	Screwdrivers for TORX® Tamper Resistant screws /T10x75-T15x75-T20x100-T25x100-T27x100-T30x125-T40x150	324 STX

gr	code	item/size
810	U03240662	1

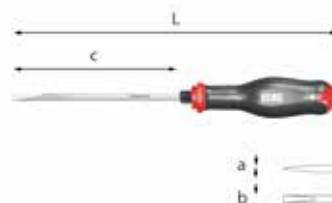

### 324 H

ISO 2380-1

#### Screwdrivers with beating zone for slot-head screws

- Model with hexagonal drive and hexagonal blade for powerful tightening, also with a wrench
- Metal rear dome to protect the beating zone
- Zinc-plated tip for high resistance to wear and corrosion
- Chrome Silicon Vanadium steel blade for excellent resistance to flexion
- Ergonomic three-material grip with soft coating, resistant to oils and chemicals
- Colour code on the handle for quick identification of the different shapes

axbxc mm	L mm	Ø mm	handle size	code	item/size
0,8x4x100	204		M1	U03240533	1
1x5,5x125	234	8	M2	U03240534	1
1,2x6,5x150	270	10	M3	U03240535	1
1,2x8x175	300	11	M4	U03240536	1
1,6x10x175	300	12	M4	U03240537	1
2x12x200	300	14	M4	U03240538	1
2,5x14x250	375	14	M4	U03240539	1



### D 324 H

ISO 2380-1

#### Screwdrivers with beating zone for slot-head screws

axbxc mm	L mm	Ø mm	code	item/size
1,2x6,5x150	270	10	U03240535D	1
1,6x10x175	300	12	U03240537D	1



### 324 HPH

ISO 8764-1

#### Screwdrivers with beating zone for PHILLIPS® screws

- Model with hexagonal drive and hexagonal blade for powerful tightening, also with a wrench
- Metal rear dome to protect the beating zone
- Zinc-plated tip for high resistance to wear and corrosion
- Chrome Silicon Vanadium steel blade for excellent resistance to flexion
- Ergonomic three-material grip with soft coating, resistant to oils and chemicals
- Colour code on the handle for quick identification of the different shapes

n°xa	L mm	Ø mm	handle size	code	item/size
1x100	209	8	M2	U03240541	1
2x125	245	10	M3	U03240542	1
3x150	275	12	M4	U03240543	1



### D 324 HPH

#### Screwdrivers with beating zone for PHILLIPS® screws

n°xa	L mm	Ø mm	code	item/size
2x125	245	10	U03240542D	1



### 324 H/SH3

#### Set of 3 screwdrivers with beating zone for slot-head and PHILLIPS® screws

pcs	description	item/size
2	Screwdrivers with beating zone for slot-head screws/1,2x6,5x150-1,6x10x175	324 H
1	Screwdrivers with beating zone for PHILLIPS® screws/2x125	324 HPH

gr	code	item/size
400	U03240670	1

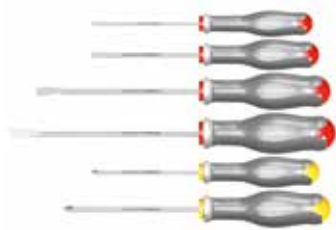

### 324 I/SH6

by **FALCOM**

#### Set of 6 screwdrivers in stainless steel for slot-head and PHILLIPS® screws

- 0,8x4x100-1x5,5x100-1,2x6,5x150-1,2x8x175
- PHILLIPS®: PH1x100-PH2x125
- Ergonomic three-material grip with soft coating, resistant to oils and chemicals
- Colour code on the handle for quick identification of the different shapes

gr	code	
580	U03240680	1



1/4

### 324 XP/B16



#### Bag with power assist screwdriver and bits (16 pcs)

- Set with long bits, power assist screwdriver and nylon bag
- Internal electric engine to give speed
- Compact dimensions to allow hand use
- 3.6V Lithium battery with 2.0 Ah capacity
- Magnetic 1/4" bits holder with quick release ring
- 5 front side LED with 10 seconds automatic switch-off
- Automatic locking system of the chuck to apply hand torque
- Ergonomic rubber handle resistant to oils and chemicals
- IP54 protection
- Rechargeable with USB-C cable (included)
- Charge status LED
- High resistance nylon bag with belt hook
- Bits holder elastics and USB-C cable pocket

pcs	description	item/size
1	Power assist screwdriver	324 XP
2	Bits for slot-head screws - 1/4" / 0,6x4-0,8x5,5	664
4	Bits for hex socket screws - 1/4" / 3-4-5-6	664 E
2	Bits for PHILLIPS® screws - 1/4" / 1-2	664 PH
2	Bits for POZIDRIV®-SUPADRIV® screws - 1/4" / 1-2	664 PZ
5	Bits for TORX® screws - 1/4" / T10-T15-T20-T25-T30	664 TX

code	
U03240801	1



### 324 XP

#### Power assist screwdriver

- Internal electric engine to give speed
- Compact dimensions to allow hand use
- 3.6V Lithium battery with 2.0 Ah capacity
- Magnetic 1/4" bits holder with quick release ring
- 5 front side LED with 10 seconds automatic switch-off
- Automatic locking system of the chuck to apply hand torque
- Ergonomic rubber handle resistant to oils and chemicals
- IP54 protection
- Rechargeable with USB-C cable (included)
- Charge status LED

characteristics	size
RPM	300
Max torque (Nm)	0,9
Vibrations (m/s <sup>2</sup> )	1,4
Protection level	IP54
Sound power dB(A)	54
Battery type (supplied)	3,7 V Li-Ion 2 Ah

LxP mm	gr	code	
170x39	175	U03240803	1



### 324 XP/BV

#### Empty nylon pouch

- For set 324 XP/B16

code	
U03240801Q	1

**ITS SPEED**  
works with 300 rpm speed coming from the electric engine.

0,9 Nm

300 Gir/min

**POWER ASSIST SCREWDRIVER.**

**YOUR ACCURACY**  
Close the tightening with the accuracy of a standard screwdriver.

10 Nm



### 329 N

#### Screwdrivers for slot-head screws

- Ergonomic handgrip with revolving head for precision screwing action
- Special Silicon Chrome Vanadium steel blade
- Chrome plated finish with burnished tip

axbxc mm	L mm	colour	code	
0,2x1,5x35	118	Yellow	U03290001	5
0,3x1,8x35	118	Green	U03290002	5
0,4x2x35	118	Blue	U03290003	5
0,4x2x75	158	Dark Blue	U03290004	5
0,4x2,5x35	118	Light Blue	U03290005	5
0,4x2,5x75	158	Light Blue	U03290006	5
0,5x3x75	168	Red	U03290007	5
0,5x3,5x75	168	Pink	U03290008	5
0,8x4x75	168	Purple	U03290009	5



### D 329 N

#### Screwdrivers for slot-head screws

axbxc mm	L mm	colour	code	
0,2x1,5x35	118	Yellow	U03290001D	1
0,3x1,8x35	118	Green	U03290002D	1
0,4x2,5x35	118	Light Blue	U03290005D	1



### 329 NPH

#### Screwdrivers for PHILLIPS® screws

- Ergonomic handgrip with revolving head for precision screwing action
- Special Silicon Chrome Vanadium steel blade
- Chrome plated finish with burnished tip

n°xa	colour	L mm	code	
00x35	Pink	118	U03290021	5
00x75	Pink	158	U03290022	5
0x35	Purple	118	U03290023	5
0x75	Purple	168	U03290024	5
1x75	Brown	168	U03290025	5



### D 329 NPH

#### Screwdrivers for PHILLIPS® screws

n°xa	colour	L mm	code	
00x35	Pink	118	U03290021D	1



### 329 NTX

#### Screwdrivers for TORX® screws

- Ergonomic handgrip with revolving head for precision screwing action
- Special Silicon Chrome Vanadium steel blade
- Chrome plated finish with burnished tip

n°xa	colour	L mm	code	
T5x35	Green	118	U03290041	1
T6x35	Blue	118	U03290042	1
T7x35	Light Blue	118	U03290043	1

## 329 NTX

n°xa	colour	L mm	code	
T8x75	Red	168	U03290044	1
T9x75	Pink	168	U03290045	1
T10x75	Purple	168	U03290046	1
T15x75	Brown	168	U03290047	1
T20x75	Grey	168	U03290048	1



### D 329 NTX

#### Screwdrivers for TORX® screws

n°xa	colour	L mm	code	
T5x35	Green	118	U03290041D	1
T6x35	Blue	118	U03290042D	1



### 329 N/S5

#### Set of 5 screwdrivers for slot-head and PHILLIPS® screws

- Supplied in plastic box
- Ergonomic handgrip with revolving head for precision screwing action
- Special Silicon Chrome Vanadium steel blade
- Chrome plated finish with burnished tip

pcs description	item/size
4 Screwdrivers for slot-head screws / 0,2x1,5x35-0,3x1,8x35-0,4x2x35-0,4x2,5x35	329 N
1 Screwdrivers for PHILLIPS® screws / 00x35	329 NPH

gr	code	
155	U03290056	1



### 329 N/S8

#### Set of 8 screwdrivers for slot-head and PHILLIPS® screws

- Supplied in plastic box
- Ergonomic handgrip with revolving head for precision screwing action
- Special Silicon Chrome Vanadium steel blade
- Chrome plated finish with burnished tip

pcs description	item/size
5 Screwdrivers for slot-head screws / 0,4x2x75-0,4x2,5x75-0,5x3x75-0,5x3,5x75-0,8x4x75	329 N
3 Screwdrivers for PHILLIPS® screws / 00x75-0x75-1x75	329 NPH

gr	code	
330	U03290057	1



### 329 NTX/S8

#### Set of 8 screwdrivers for TORX® screws

- Supplied in plastic box
- Ergonomic handgrip with revolving head for precision screwing action
- Special Silicon Chrome Vanadium steel blade
- Chrome plated finish with burnished tip

pcs description	item/size
8 Screwdrivers for TORX® screws / T5x35-T6x35-T7x35-T8x75-T9x75-T10x75-T15x75-T20x75	329 NTX

gr	code	
320	U03290058	1

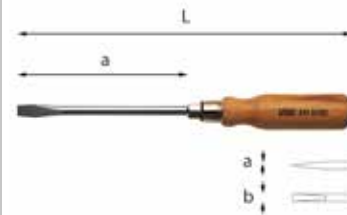

### 331

#### Screwdrivers for slot-head screws

- Wooden grip with leather-covered dome
- Full-length Chrome Vanadium steel blade with hexagonal drive
- Chrome plated finish

axbxc mm	L mm	mm	code	
1x5,5x100	200	10	U03310102	5
1,2x6,5x125	238	10	U03310103	5
1,2x8x150	275	12	U03310104	5
1,6x10x175	304	12	U03310105	5
2x12x200	330	14	U03310106	5
2,5x14x250	380	16	U03310107	5



### 331 PH

#### Screwdrivers for PHILLIPS® screws

- Wooden grip with leather-covered dome
- Full-length Chrome Vanadium steel blade with hexagonal drive
- Chrome plated finish

n°xa	L mm	mm	code	
2x100	210	10	U03310202	5
3x150	265	12	U03310203	5



### 333 K

#### COMBIDRIVE handgrip with 3 functions

- Ergonomic bimaterial grip
- Integrated reversible ratchet: maximum permissible torque 60 Nm
- Inner housing for six bits 1/4"
- RATCHETING SCREWDRIVER function: inserting the blade into the front hole, it can operate as a standard screwdriver or using the built-in reversible ratchet
- T-WRENCH function: inserting the blade into the side hole, you can have a T-handle for greater screwing power
- SHORT SCREWDRIVER function: integrated in the rear part there is a short screwdriver magnetic bit holder

°	a mm	b mm	L mm	code	
1/4"	270	180	140	U03330001	1

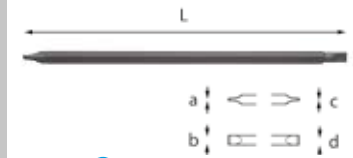

### 333 I

ISO 2380-1

#### Reversible COMBIDRIVE blades for slot-head screws

- Special Silicon Chrome Vanadium steel
- Chrome plated finish

axb mm	cx d mm	L mm	code	
0,6x3,5	0,8x4	175	U03330103	1
1x5,5	1,2x6,5	175	U03330104	1



### 333 PH

ISO 8764-1

#### Reversible COMBIDRIVE blades for PHILLIPS® screws

- Double end with different size
- Special Silicon Chrome Vanadium steel
- Sanded oiled finish

n°	L mm	code	
0-1	175	U03330106	1
1-2	175	U03330107	1
2-3	175	U03330108	1



### 333 TX

#### Reversible COMBIDRIVE blades for TORX® screws

- Double end with different size
- Special Silicon Chrome Vanadium steel
- Sanded oiled finish

n°	L mm	code	
T8-T9	175	U03330121	1
T10-T15	175	U03330122	1
T20-T25	175	U03330123	1
T30-T40	175	U03330124	1



### 333 E

ISO 2936

#### Reversible COMBIDRIVE blades for hex socket screws

- Double end: standard and spherical
- Special Silicon Chrome Vanadium steel
- Sanded oiled finish

● mm	L mm	code	
2,5	175	U03330131	1
3	175	U03330132	1
4	175	U03330133	1
5	175	U03330134	1
6	175	U03330135	1



### 333 1/4" MG

#### COMBIDRIVE magnetic bit-holder

- Integrated magnet
- 1/4" hexagonal shank
- Special Silicon Chrome Vanadium steel
- Chrome plated finish

○"	a mm	L mm	code	
1/4	10	160	U03330136	1



### 333 1/4" Q

#### COMBIDRIVE sockets holder

- Sockets holder drive square with retaining ball
- 1/4" hexagonal shank
- Special Silicon Chrome Vanadium steel
- Chrome plated finish

■"	L mm	code	
1/4	160	U03330137	1



### 333 K/SH8

#### COMBIDRIVE set with bits (8 pcs)

- 3in1 COMBIDRIVE handle: ratchet screwdriver, T wrench and stubby screwdriver
- Magnetic bits holder included
- Delivered with 6 different bits 1/4"

pcs	description	item/size
1	COMBIDRIVE magnetic bit-holder	333 1/4 MG
1	COMBIDRIVE handgrip with 3 functions	333 K
2	Bits for slot-head screws -1/4" / 0,6x4,5-1x5,5	660
2	Bits for hex socket screws -1/4" / 3-4	660 E
2	Bits for PHILLIPS® screws -1/4" / 1-2	660 PH

code	
U03330142	1



### 333 K/SB10

#### COMBIDRIVE set in nylon bag (10 pcs)

- 3in1 COMBIDRIVE handle: ratchet screwdriver, T wrench and stubby screwdriver
- Magnetic bits holder included
- Delivered with 8 different blades
- Nylon bag with belt hook

pcs	description	item/size
1	COMBIDRIVE magnetic bit-holder	333 1/4 MG
2	Reversible COMBIDRIVE blades for slot-head 333 I screws/(0,6x3,5-0,8x4)-(1x5,5-1,2x6,5)	
1	COMBIDRIVE handgrip with 3 functions	333 K
2	Reversible COMBIDRIVE blades for PHILLIPS® screws/(0-1)-(2-3)	333 PH
4	Reversible COMBIDRIVE blades for TORX® screws/(T8-T9)-(T10-T15)-(T20-T25)-(T30-T40)	333 TX
1	Empty nylon pouch	333 K/BV

code	
U03330143	1



### 333 K/SB9E

#### COMBIDRIVE set in nylon bag (10 pcs)

- 3in1 COMBIDRIVE handle: ratchet screwdriver, T wrench and stubby screwdriver
- Delivered with 9 different blades
- Nylon bag with belt hook

pcs	description	item/size
4	Reversible COMBIDRIVE blades for hex socket screws/2,5-3-4-5	333 E
2	Reversible COMBIDRIVE blades for slot-head 333 I screws/(0,6x3,5-0,8x4)-(1x5,5-1,2x6,5)	
1	COMBIDRIVE handgrip with 3 functions	333 K
2	Reversible COMBIDRIVE blades for PHILLIPS® screws/(0-1)-(2-3)	333 PH
1	Empty nylon pouch	333 K/BV

code	
U03330148	1



### 333 K/BV

#### Empty nylon pouch

- For screwdriver set 333 K/SB10 - 333 K/SB10E

code	
U03330008Q	1



### 333 K/SC23

#### COMBIDRIVE set in plastic case (23 pcs)

- 3in1 COMBIDRIVE handle: ratchet screwdriver, T wrench and stubby screwdriver
- Magnetic bits holder and sockets holder included
- Delivered with 12 different blades and 8 bits 1/4"
- ABS case with internal bicolor foam
- Empty inner foam module: code U05190978Q

pcs	description	item/size
1	COMBIDRIVE magnetic bit-holder	333 1/4 MG
1	COMBIDRIVE sockets holder	333 1/4 Q
5	Reversible COMBIDRIVE blades for hex socket screws/2,5-3-4-5-6	333 E
1	Reversible COMBIDRIVE blades for slot-head 333 I screws/(1x5,5-1,2x6,5)	
1	COMBIDRIVE handgrip with 3 functions	333 K
2	Reversible COMBIDRIVE blades for PHILLIPS® screws/(0-1)-(2-3)	333 PH
4	Reversible COMBIDRIVE blades for TORX® screws/(T8-T9)-(T10-T15)-(T20-T25)-(T30-T40)	333 TX
4	Bits for slot-head screws -1/4" / (0,6x4,5)-(1x5,5)-(1,2x6,5)-(1,6x8)	660
4	Bits for POZIDRIV® - SUPADRIV® screws -1/4" / 0-1-2-3	660 PZ
1	Bi-colour foam module (empty)	519 M 333KV
1	Empty ABS case - size L	606 L

LxPxH mm	code	
435x270x70	U03330149	1



### 340

ISO 2380-1

#### Offset screwdrivers for slot-head screws

- For working on screws not accessible from the axial direction
- Blade heads set at right angles to each other to allow a working angle of 90°
- Special Silicon Chrome Vanadium steel
- Nickel plated finish

axb mm	c mm	L mm	code	
0,5x3	18	90	U03400006	5
0,6x3,5	21	90	U03400007	5
0,8x4	20	90	U03400008	5
1x5,5	21	125	U03400002	5
1,2x8	22	150	U03400003	5
1,6x10	27	175	U03400004	5



### 340 PH

ISO 8764-1

#### Offset screwdrivers for PHILLIPS® screws

- For working on screws not accessible from the axial direction
- Special Silicon Chrome Vanadium steel
- Nickel plated finish

n°	a mm	L mm	code	
0-1	18	90	U03400010	5
1-2	22	125	U03400011	5
3-4	30	175	U03400012	5



### 341 SH9

#### Precision screwdriver with 8 interchangeable blades

- Ideal for precision working on glasses, electronic devices or small appliances
- Ergonomic monomaterial handle
- Steel blades, Chrome plated
- Supplied in plastic case
- Contents:
  - 6 blades for slot-head screws 1-1,2-1,5-1,8-2-2,5 mm
  - 2 blades for PHILLIPS® screws PH 00-000

LxPxH mm	g	code	
135x195x25	78	U03410015	1



### 341 SH17

#### Precision screwdriver with 16 interchangeable blades

- Ideal for precision working on glasses, electronic devices or small appliances
- Ergonomic monomaterial handle
- Steel blades, Chrome plated
- Supplied in plastic case
- Contents:
  - 6 bits for slot-head screws 1-1,2-1,5-1,8-2-2,5 mm
  - 2 bits for PHILLIPS® screws PH 00-000
  - 4 bits for TORX® screws T5-T6-T7-T8
  - 4 bits for hex socket screws 0,9-1,3-1,5-2 mm

LxPxH mm	g	code	
135x195x25	195	U03410016	1



### 341 SH33

#### Precision bit-holder screwdriver with 32 bits

- Ideal for precision working on glasses, electronic devices or small appliances
- Ergonomic monomaterial handle
- Steel blades, Chrome plated
- Bits with 4 mm shank
- Supplied in plastic case
- Contents:
  - 7 bits for slot-head screws 1-1,2-1,5-1,8-2-2,5-3 mm
  - 3 bits for PHILLIPS® screws PH 0-00-000
  - 2 bits for POZIDRIV® screws PZ 0-1
  - 5 bits for TORX® screws T5-T6-T7-T8-T9
  - 3 bits for Resistorx screws T10-T15-T20
  - 7 bits for hex socket screws 0,9-1,3-1,5-2-2,5-3-4 mm
  - 2 bits for square screws PT 0-1
  - 3 bits for Torq-set® screws PT 2-3-4

LxPxH mm	g	code	
135x195x25	137	U03410019	1



### 341 SH4TX

#### Set of 4 precision screwdrivers for TORX® screws

- Ideal for working on portable electronic devices such as smartphones, tablets etc.
- Ergonomic monomaterial handle
- Steel blades, Chrome plated
- Supplied in plastic case
- Contents:
  - 4 screwdrivers for TORX® screws T6-T7-T8-T9

LxPxH mm	g	code	
135x195x25	195	U03410017	1



### 341 SH6

#### Set of 6 precision screwdrivers for slot-head and PHILLIPS® screws

- Ideal for precision working on glasses, electronic devices or small appliances
- Ergonomic monomaterial handle
- Steel blades, Chrome plated
- Supplied in plastic case
- Contents:
  - 4 screwdrivers for slot-head screws 1-1,2-1,5-1,8 mm
  - 2 screwdrivers for PHILLIPS® screws PH 00-000

LxPxH mm	g	code	
135x195x25	168	U03410018	1



### 342

#### Precision screwdrivers for slot-head screws

- Model for the micromechanical sector
- Revolving head for precision screwing action
- Body and blade in Carbon steel
- Chrome plated and burnished finish

a mm	b mm	colour	L mm	code	
0,6	10		80	U03420006	5
0,8	10		80	U03420008	5
1	15		88	U03420010	5
1,2	16		88	U03420012	5
1,4	18		95	U03420014	5
1,6	18		95	U03420016	5
2	20		102	U03420020	5
2,5	22		102	U03420025	5



### 342 PH

#### Precision screwdrivers for PHILLIPS® screws

- Model for the micromechanical sector
- Revolving head for precision screwing action
- Body and blade in Carbon steel
- Chrome plated and burnished finish

n°	b mm	colour	L mm	code	
00	18		95	U03420101	5
0	20		102	U03420102	5
1	20		102	U03420103	5



### 342 SE8

#### Set of 8 precision screwdrivers for slot-head and PHILLIPS® screws

- Model for the micromechanical sector
- Revolving head for precision screwing action
- Body and blade in Carbon steel
- Chrome plated and burnished finish
- Supplied in plastic pouch

pcs	description	item/size
5	Precision screwdrivers for slot-head screws 342 /0,8-1-1,4-1,6-2	
3	Precision screwdrivers for PHILLIPS® screws/00-0-1	342 PH
1	Empty pouch	342 SV8

g	code	
115	U03420088	1



### 342 SV8

#### Empty pouch

- For screwdriver set 342 SE8

code	
U03420108R	1

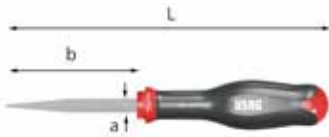

**345**

**Square tip drifts**

- Ergonomic three-material grip with soft coating, resistant to oils and chemicals
- Steel blade with square section

a mm	b mm	L mm	code	
6	80	195	U03450116	1
8	125	220	U03450118	1



**D 345**

**Square tip drifts**



a mm	b mm	L mm	code	
6	80	195	U03450116D	1



**346**

**Wrecking bars for carpenters**

- Model with octagonal section, one chisel tip and one curved claw tip
- Silicon Manganese steel

L mm	a mm	c mm	code	
600	18	35	U03460001	2
800	18	40	U03460002	2

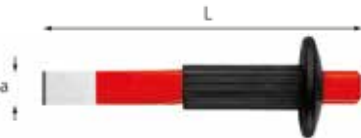

**350 A**

**Chisel with hand guard**

- Protective rubber hand guard
- Chrome Vanadium forged steel with special treatment on edges
- Re grindable edge
- Head treated to prevent chipping

L mm	a mm	h gr	code	
250	27	610	U03500001	1
300	27	710	U03500002	1



**351**

**Ribbed chisels**

- Forged Chrome Vanadium steel
- Re grindable edge

L mm	a mm	h gr	code	
150	21	164	U03510003	5
175	24	266	U03510004	5
200	26	330	U03510005	5
250	29	520	U03510006	5
300	32	813	U03510007	5

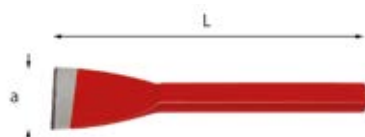

**353**

**Chisel with extra wide cutting edge**

- Forged Chrome Manganese Silicon steel
- Re grindable edge

L mm	a mm	code	
250	60	U03530001	2

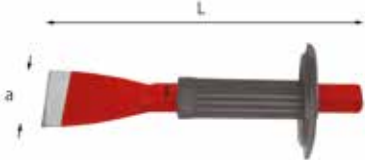

**353 A**

**Chisel with extra wide cutting edge and hand guard**

- Forged Chrome Manganese Silicon steel
- Protective rubber hand guard
- Re grindable edge

L mm	a mm	code	
250	60	U03530002	1



**354**

**Extra flat chisel**

- Forged Chrome Vanadium steel
- Re grindable edge
- Blade thickness: 2 mm

L mm	a mm	code	
235	26	U03540001	5

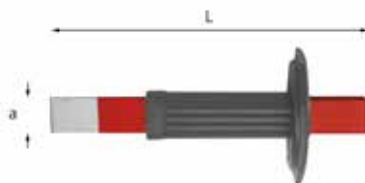

**354 A**

**Extra flat chisel with hand guard**

- Forged Chrome Vanadium steel
- Protective rubber hand guard
- Re grindable edge
- Blade thickness: 2 mm

L mm	a mm	code	
235	26	U03540002	1



**355**

**Drill drifts**

- Chrome Vanadium steel

n°	L mm	code	
1-2	140	U03550002	5
3	195	U03550003	5
4	220	U03550004	5
5-6	265	U03550005	5

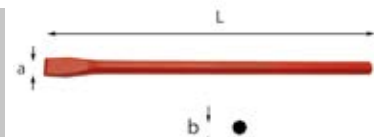

**359**

**Chisels for electricians**

- Chrome Manganese Silicon steel
- Re grindable edge
- Octagonal section

axL mm	b mm	code	
14x200	10	U03590003	5
14x250	10	U03590004	5

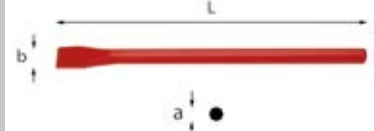

**360**

**Chisels for masons**

- Forged Manganese Silicon steel
- Re grindable edge
- Octagonal section

L mm	a mm	b mm	code	
300	16	22	U03600001	2
400	16	26	U03600002	2

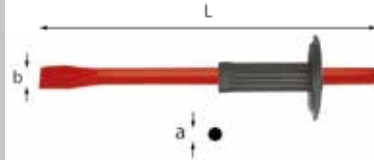

**360 A**

**Chisels for masons with hand guard**

- Forged Manganese Silicon steel
- Protective rubber hand guard
- Re grindable edge
- Octagonal section

L mm	a mm	b mm	code	
300	16	22	U03600003	1
400	16	26	U03600004	1



**361 R**

**Spare hand guard**

- For chisels 360 A

length of chisel mm	code	
300-400	U03610005	1



**362**

**Chisels**

- Forged Chrome Vanadium steel
- Re grindable edge
- Chrome plated finish

L mm	a mm	b mm	code	
125	12	10	U03620001	10
150	18	12	U03620002	10
175	22	16	U03620003	10

**DIN 6453**



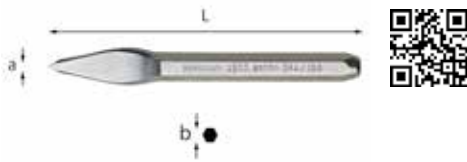

**364**

**DIN 6451**

**Cross cut chisel**

- Chrome Vanadium steel
- Re grindable edge
- Chrome plated finish

L mm	a mm	b mm	code	
125	4	10	U03640001	10

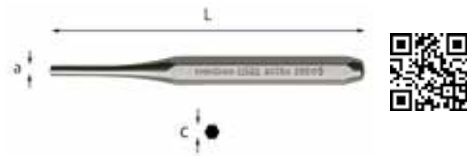

**366**

**DIN 6458**

**Drift punches**

- Chrome Vanadium steel
- Chrome plated finish

axL mm	c mm	code	
2x125	10	U03660101	10
3x125	10	U03660201	10
4x150	12	U03660102	10
5x150	12	U03660202	10
6x150	12	U03660203	10



**366 SE5**

**Set of 6 drift punches**

pcs	description	item/size
5	Drift punches/ 2x125-4x150-3x125-5x150-6x150	366

code	
U03660081	1



**367**

**DIN 6450**

**Pin punches**

- Chrome Vanadium steel
- Inserted phosphatised tips for the 2 and 3 mm sizes

axL mm	c mm	code	
2x115	8	U03670003	10
3x125	8	U03670005	10
4x145	10	U03670006	10
5x165	10	U03670007	10
6x180	12	U03670008	10
8x200	12	U03670009	10
10x210	12	U03670010	10



**367 SE6**

**Set of 6 pin punches**

- Supplied in plastic pouch
- Chrome Vanadium steel
- Inserted phosphatised tips for the 2 and 3 mm sizes

pcs	description	item/size
6	Pin punches/2x115-3x125-4x145-5x165-6x180-8x200	367
1	Empty pouch	367 SE6

g	code	
510	U03670081	1



**367 SEV6**

**Empty pouch**

- For punches set 367 SE6

code	
U03670101	1



**367 S7**

**Set of 7 pin punches**

- Supplied with metal holder
- Chrome Vanadium steel
- Phosphatised tips for the 2 and 3 mm sizes

pcs	description	item/size
7	Pin punches /2x115-3x125-4x145-5x165-6x180-8x200-10x210	367
1	Empty metal holder	367 SV7

g	code	
860	U03670181	1



**367 SV7**

**Empty metal holder**

- For sets of pin punches 367 S7 and 372 S7

g	code	
215	U03670001Q	1

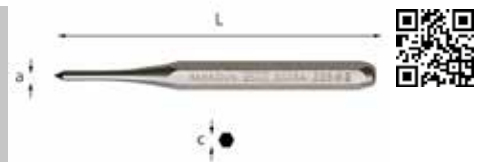

**368**

**DIN 7250**

**Centre punches**

- Chrome Vanadium steel
- Chrome plated finish

axL mm	c mm	code	
3x100	8	U03686001	10
4x125	10	U03680002	10
5x150	12	U03680003	10



**368 B**

**Automatic centre punch**

- Spring-loaded model
- Depth of cut controllable by rotating the head
- Re grindable edge
- Strength stroke: 110 to 220 N

L mm	a mm	c mm	g	code	
155	7	23	135	U03680001	5



**368 BR**

**Spare tip**

- For automatic centre punch 368 B

L mm	g	code	
50	15	U03680001Q	10



**372 S7**

**Assortment with metal holder (7 pcs.)**

- Chrome Vanadium steel

pcs	description	item/size
2	Chisels	362/125-150
1	Cross cut chisel	364/125
3	Drift punches/3x125-4x150-5x150	366
1	Centre punches	368/4x125
1	Empty metal holder	367 SV7

g	code	
820	U03720082	1



### 372 SE6

#### Assortment in plastic pouch (6 pcs.)

- Chrome Vanadium steel

pcs	description	item/size
2	Chisels	362/125-150
1	Cross cut chisel	364/125
2	Drift punches/3x125-4x150	366
1	Centre punches	368/4x125
1	Empty pouch	372 SEV6

a gr	code	
860	U03720181	1



### 372 SEV6

#### Empty pouch

- For sets 372 SE6 and 040 SE6

code	
U03720101	1



### 374 N

#### Non-rebound mallets

- Model with interchangeable plastic tips
- Head partially filled with metal pellets to absorb rebound
- Carbon steel body

a mm	b mm	L mm	code	
35	116	310	U03740004	2
40	125	315	U03740005	2
50	133	325	U03740006	2
60	142	335	U03740007	2

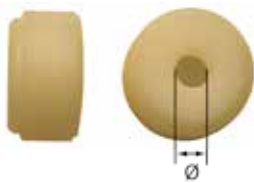

### 374 NB

#### Spare pair of plastic tips

- For mallets 374 N

Ø tip	Ø hole mm	code	
35	15	U03740014Q	5
40	17	U03740015Q	5
50	20	U03740016Q	5
60	22	U03740017Q	5

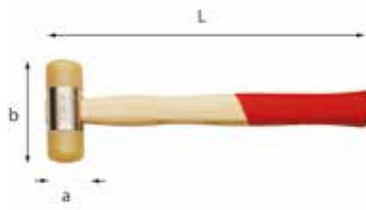

### 376

#### Mallets

- Model with interchangeable plastic tips
- Carbon steel body
- Ash wood handle

UNI 7784

a mm	b mm	L mm	code	
22	74	250	U03760001	4
28	88	275	U03760002	4
35	97	300	U03760003	4
42	108	325	U03760004	4
50	112	350	U03760005	2
60	128	380	U03760006	2

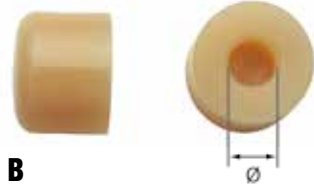

### 376 B

#### Spare pair of plastic tips

- For mallets 376 22÷60 and 377/35

Ø tip	Ø hole mm	code	
22	10	U03760201	5
28	12	U03760202	5
35	14,5	U03760203	5
42	17	U03760204	5
50	18,5	U03760205	5
60	22	U03760206	5



### 376 E

#### Spare handles

- For mallets 376 22÷60 and 377/35

Ø tip	code	
22	U03760101	5
28	U03760102	5
35	U03760103	5
42	U03760104	5
50	U03760105	5
60	U03760106	5



### 376 F

#### Mallets with graphite handle

- Model with interchangeable tips in cellulose acetate
- Carbon steel body
- Graphite handle

a mm	b mm	L mm	code	
25	80	280	U03760012	4
32	92	304	U03760013	4
40	100	330	U03760014	4
50	119	362	U03760015	2

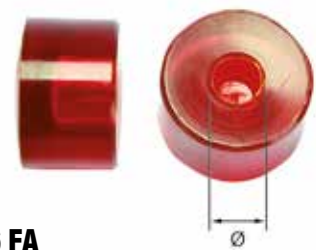

### 376 FA

#### Spare pair of plastic tips

- For mallets 376 F 25÷50

Ø tip	Ø hole mm	code	
25	9,3	U03760012Q	5
32	11,3	U03760013Q	5
40	13,3	U03760014Q	5
50	16,3	U03760015Q	5



### 377

#### Mallet

- Model with combination striking surfaces steel and plastic
- Interchangeable tip
- Carbon steel head
- Ash wood handle

a mm	b mm	L mm	code	
35	95	310	U03770003	2



### 378

#### Mallets

- Model with double rounded head in hard rubber
- Ash wood handle

a mm	b mm	L mm	code	
50	90	320	U03780004	2
55	110	330	U03780005	2
70	115	330	U03780006	2



### 378 AN

#### Spare handles

- For mallets 378 50÷70

a mm	gr	code	
60	98	U03780007Q	1



**380** UNI 7777 DIN 6475

**Sledge hammers**

- Double-headed with square flat heads
- Ash wood handle

gr	b mm	L mm	code	
1000	95	260	U03800002	4
1250	100	260	U03800003	2
1500	110	280	U03800004	2
2000	120	300	U03800005	2



**380 AN**

**Spare handles**

- For sledge hammers 380 1000÷2000

gr	code	
1000	U03800002Q	5
1250	U03800003Q	5
1500	U03800004Q	5
2000	U03800005Q	5



**382** UNI 7778 DIN 1041

**Hammers for mechanics**

- German model with flat square head and symmetric peen
- Ash wood handle

gr	c mm	L mm	code	
100	82	260	U03820002	8
200	95	280	U03820004	8
300	105	300	U03820006	8
400	112	310	U03820007	8
500	118	320	U03820008	8
600	122	330	U03820009	4
800	130	350	U03820010	4
1000	135	360	U03820011	4
1500	145	380	U03820013	4
2000	155	400	U03820014	2



**382 EN**

**Spare handles**

- For hammers 382 100÷2000

gr	code	
100	U03820002Q	5
200	U03820004Q	5
300	U03820006Q	5
400	U03820007Q	5
500	U03820008Q	5
600	U03820009Q	5
800	U03820010Q	5
1000	U03820011Q	5
1500	U03820013Q	5
2000	U03820014Q	5



**382 F** DIN 1041

**Hammers for mechanics with graphite handle**

- German model with flat square surface and symmetric peen
- Graphite handle

gr	c mm	L mm	code	
200	95	285	U03820102	4
300	105	300	U03820103	4
500	118	310	U03820105	4
800	130	350	U03820107	4
1000	135	355	U03820108	4



**383 N** UNI 7779

**Hammers for mechanics**

- American model with flat round head and ball peen
- Hickory handle

gr	c mm	L mm	code	
450	101	350	U03830012	2
680	121	400	U03830013	2
910	126	400	U03830014	2



**383 NA**

**Spare handles**

- For hammers 383 N 450÷910

gr	code	
450	U03830016	5
680	U03830017	5
910	U03830018Q	5



**384**

**Hammers for mechanics**

- French model with flat rectangular head and asymmetric peen
- Ash wood handle

a mm	c mm	L mm	code	
30	92	280	U03840014	2
42	117	330	U03840018	2



**384 AN**

**Spare handles**

- For hammers 384 30÷42

a mm	code	
42	U03840028Q	2



**390**

**Copper sledge hammers**

- Double-headed with square flat heads
- Ash wood handle

gr	b mm	L mm	code	
300	68	270	U03900011	2
500	80	270	U03900012	2
800	90	270	U03900013	2
1000	100	270	U03900014	2



**390 A**

**Spare handles**

- For sledge hammers 390 300÷1000

gr	code	
300	U03900001Q	2
500	U03900002Q	2
800	U03900003Q	2
1000	U03900004Q	2



**391 CE**

**Digital heat gun**

- Model with electronic checking of temperature and air volume by digital display
- Possibility to set programs: 2 heating modes and 2 air flows selectable
- Equipped with a cooling system
- Supplied with one wide slit nozzle and one deflector nozzle

characteristics	size
Power absorbed (W)	2000
Operating temperature (°C)	50-600
Air flow (l/min)	650

LxPxH mm	gr	code	
250x72x210	980	U03910001	1

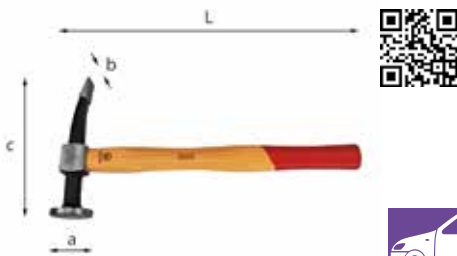

**392**

**Hammer with flat round and curved chisel heads**

- Handle in hickory

L mm	a mm	b mm	c mm	code
290	40	19	140	U03920001

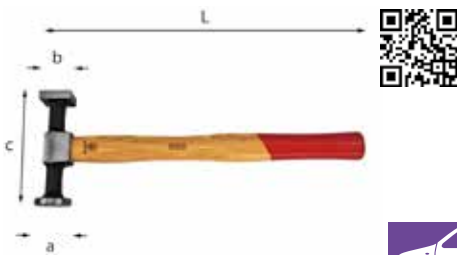

**393**

**Hammer with flat round and flat square heads**

- Handle in hickory

L mm	a mm	b mm	c mm	code
290	32	28	104	U03930001

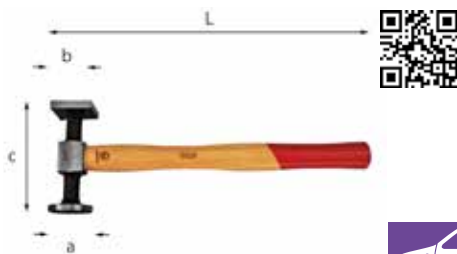

**393 ZG**

**Hammers with serrated round and smooth square heads**

- Handle in hickory

L mm	a mm	b mm	c mm	code
290	32	28	104	U03930101
290	40	38	99	U03930102



**395 AN**

**Spare handle**

- For hammers 392-393-393 ZG-413 B-414 A-415 A

kg	code
170	U03950012Q



**400 P**

**Pneumatic dent puller**

- Ideal to remove dents without the need to repaint
- Supplied with 3 suction cups (Ø 75-100-125 mm), in a plastic case with transport handle and closure clip
- Spare part kit with 3 suction cups: code 1004735-98

characteristics	size
Sound level (dB)	78
Recommended air pressure (bar)	6,2
Air inlet (")	1/4

LxPxH mm	kg	code
610x95x235	4	U04000010

**401**

**Comma shaped wedged dolly**

LxPxH mm	kg	code
140x54x55	1,3	U04010001

**401 A**

**Large grooved dolly**

LxPxH mm	gr	code
106x65x26	800	U04010101

**402 A**

**Dolly for body repair**

LxPxH mm	gr	code
88x60x23	750	U04020001

**402 B**

**Dolly for body repair**

LxPxH mm	kg	code
88x60x35	1,1	U04020002



**402 C**

**Dolly for body repair**

LxPxH mm	kg	code
90x55x35	1,1	U04020003



**404**

**Dolly for body repair**

LxPxH mm	kg	code
130x68x25	1,1	U04040001



**410 C**

**Double spoon with one curved blade and a flat one**

L mm	kg	code
400	1,7	U04100101



**411**

**Facing narrow body spoon, long model**

L mm	kg	code
390	1,3	U04110001



**412**

**Light curved spoon, short model**

L mm	gr	code
285	800	U04120001



**412 B**

**Flat serrated spoon for thinning out operations**

L mm	gr	code
350	700	U04120002

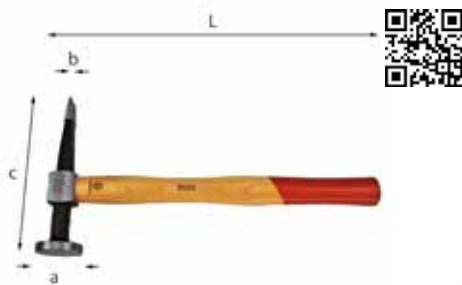

### 413 B

#### Hammer with round flat head and horizontal chisel peen

- Handle in hickory

L mm	a mm	b mm	c mm	code	
290	40	19	140	U04130101	1

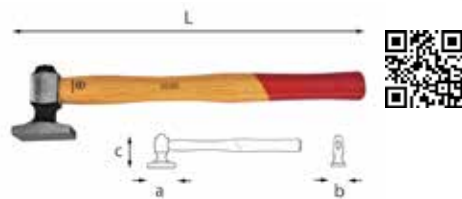

### 414 A

#### Hammer with flat rectangular head

- Handle in hickory

L mm	a mm	b mm	c mm	code	
290	48	30	60	U04140001	1

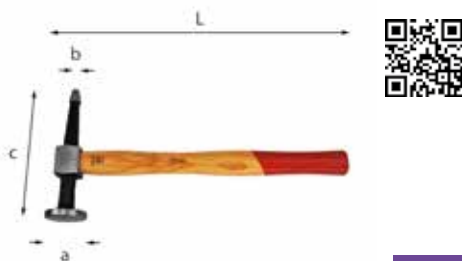

### 415 A

#### Hammer with flat round head and straight pointed peen

- Handle in hickory

L mm	a mm	b mm	c mm	code	
290	40	12	138	U04150001	1

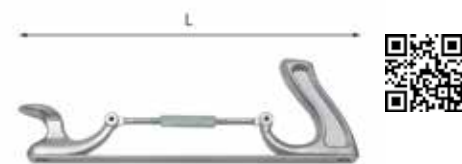

### 416 N

#### Adjustable file holder

- Screw adjustment for matching straight or curved contours  
- Adjustable for two lengths: 300 and 350 mm

L mm	code	
360	U04160002	1

### 416 NA

#### Flat flexible files

- For use with adjustable file holder 416 N

teeth/cm cm	L mm	cut	code	
3,5	350	standard	U04160004Q	5
4,5	350	fine	U04160005Q	5

### 418

#### Oilers

- Model with retractable rigid metal spout and a screw-type valve in the cap  
- Plastic body

capacity cc	code	
30	U04180001	5
70	U04180002	5
150	U04180003	5



### 419

#### Oilers

- Pump model with rigid metal spout and plastic body

capacity cc	code	
200	U04190001	4
300	U04190002	4
500	U04190003	4

### 419 A

#### Spare spout

- For oilers 419

gr	code	
12	U04190011	5



### 420

#### Oilers

- Pump model with flexible metal spout and enamelled sheet steel body  
- Ergonomic plastic handgrip

capacity cc	code	
200	U04200000	4
300	U04200001	4
500	U04200002	4

### 420 AR

#### Spare spout

- For oilers 420

gr	code	
30	U04200015	1



### 421

#### Lever operated grease pumps

- Model with automatic grease feed to be filled from a bulk container or from a cartridge  
- Feed pressure 400 bar  
- Supplied with flexible connection 300 mm and four-claw gripping tweezer  
- Threaded connection M10x1  
- Sheet steel body

capacity cc	L mm	code	
500	280	U04210002	1
750	340	U04210003	1
1000	400	U04210004	1



### 421/120

#### Mini lever operated grease pumps

- Only for grease in bulk  
- Model with automatic grease feed  
- Feed pressure 413 bar  
- Tube diameter 36 mm  
- Supplied with flexible connection 300 mm and four-claw gripping tweezer  
- Threaded connection M10x1  
- Steel body and lever

capacity cc	L mm	code	
120	235	U04210000	1



### 421 AR

#### Head for grease pump

- Model with four-claw gripping tweezers  
- Resistant up to a pressure of 207 bar  
- Threaded connection M10x1  
- To be used with models 421 and 421/120

gr	code	
30	U04210008	1



### 421 BR

#### Flexible tube for grease pump

- Flexible nylon tube
- Working pressure 240 bar
- Burst pressure of 800 bar
- Threaded connection M10x1
- To be used with models 421 and 421/120

L mm	code	
300	U04210010	1



NEW



### 421 P

#### Suction gun

- Polypropylene syringe
- Double gasket in NBR
- ON/OFF safety valve
- Ideal to drop oil into the car differential
- PVC pipe length 40 cm (aluminium nozzle included) external Ø 16 mm
- Aluminum nozzle Ø 10 mm, length 20 mm, equipped with plastic closing cap
- Polypropylene body Ø: 88 mm
- Not suitable for fuels and mineral oils

capacity l	L mm	g	code	
1,5	400	700	U04210020	1

### 421 PA

#### Spare washer

- For suction gun 421 P

code	
U04210022	1

NEW



### 421 CA

#### Grease cartridge

- Industrial grease for intensive use, like automotive, industrial, construction and agriculture to lubricate bearings, wheels, gears, ball joints, frames
- Anti-wear and resistant to high pressures
- Operating temperature: -20°C to +149°C / -29°F to 300°F
- NLGI Degree II

capacity cc	L mm	Ø outside mm	code	
400	240	50	U04210013	1



NEW

### 421 M

#### Suction gun

- Steel body
- Ideal for suction and dispensing (filling) of oil, antifreeze, power steering oil etc.
- It's possible to clean the inner tube by unscrewing the back cover under the lever
- Steel tube Ø 57 mm
- ØxL mm steel nozzle: 10x12 mm
- Internal part of syringe is lubricated with a light layer of oil and grease, to avoid rust and guarantee the functionality of the internal components
- Supplied with: 2 PVC pipes, length 75 mm and 310 mm, both with external Ø 15 mm and internal Ø 10 mm; 1 metal tube 156 mm long (external Ø 10 mm and internal diameter 6 mm)
- The function of the metal tube, once inserted inside the PVC tube, is to ensure precise aspiration or input of the chosen liquid

capacity cc	L mm	g	code	
500	340	790	U04210021	1



NEW

### 423 N16

#### Car body repair set (16 pcs.)

pcs	description	item/size
1	Hammer with flat round and curved chisel heads	392/40
1	Hammer with flat round and flat square heads	393/40
1	Comma shaped wedged dolly	401
1	Large grooved dolly/106x65x26	401 A
1	Dolly for body repair/88x60x23	402 A
1	Dolly for body repair/88x60x35	402 B
1	Dolly for body repair/90x55x35	402 C
1	Dolly for body repair/130x68x25	404
1	Double spoon with one curved blade and a flat one	410 C/400
1	Facing narrow body spoon, long model	411/390
1	Hammer with flat round and flat square heads	412/285
1	Flat serrated spoon for thinning out operations	412 B/350
1	Hammer with flat round head and straight pointed peen	415 A/40
1	Adjustable file holder	416 N
2	Flat flexible files/3,5-4,5	416 NA
1	Bi-colour foam module (empty)	519 M 423N16
1	Sheet steel box (empty) - size XXL	612 XXL

LxPxH mm	g	code	
575x435x127	22	U04230087	1



### 424 A1

#### Suction cup

- Designed for the positioning of small parts
- Double handle knob can be used with only one hand
- Cup in propylene (Ø 55 mm): excellent resistance to chemicals
- Polyamide handle
- Maximum load capacity 5 Kg
- Maximum dimensions: 62x55x72mm
- Do not use on too coarse, porous, dirty or wet materials

Ø mm	LxPxH mm	load capacity max Kg	code	
55	62x55x72	5	U04240101	1



### 424 A2

#### Suction cup

- Versatile and multi-purpose
- Can be used with one hand, vacuum is generated by tightening the two handles together
- Ergonomic polyamide handle
- Cup in propylene (Ø 127 mm): excellent resistance to chemicals
- Maximum load capacity 25 Kg
- Maximum dimensions: 127x127x106mm
- Do not use on too coarse, porous, dirty or wet materials

Ø mm	LxPxH mm	load capacity max Kg	code	
127	127x127x106	25	U04240102	1



### 424 A3

#### Suction cup with steel handle and manual pump

- Multifunction suction cup to carry glass, marble and materials with smooth surfaces
- Maximum load capacity 130 Kg for smooth, clean and dry surfaces at a temperature of 20° C
- Pump balanced by a spring to maintain a proper vacuum level
- To generate the vacuum it is sufficient to pump with the piston, until the red line is no longer visible
- Cup in propylene (Ø 235 mm): excellent resistance to chemicals
- Steel handle
- Maximum dimensions: 240x240x118mm
- Supplied in plastic case (305x300x130 mm)
- Do not use on too coarse, porous, dirty or wet materials

Ø mm	LxPxH mm	load capacity max Kg	g	code	
235	240x240x118	130	2,5	U04240103	1



### 424 B1/SE4

#### Pair of suction cups for door windows

- Suitable for keeping windshields in position
- Allows operator to work hands-free when working on the window operating control system
- Propylene cups (Ø 78 mm): excellent resistance to chemicals
- Steel cable Ø 2,5 mm, length 400 mm, with plastic coating to prevent damage to the body
- Maximum loading capacity 5 Kg

Ø mm	load capacity max Kg	gr	code	
78	5	110	U04240106	1



### 424 B2/SE6

#### Set of 6 suction cups for gluing operations

- To hold the bodywork upholstery or windshield during gluing/drying operations
- Central screw to adjust pressure on the glued parts
- Cups in propylene (Ø 78 mm): excellent resistance to chemicals
- ABS body to avoid damages on the parts to be assembled

Ø mm	gr	code	
78	390	U04240107	1



### 424 C1/SE3

#### Set of three tools for removing rain and light sensors

- To remove the case where the gel of the rain and light sensors is contained
- Different sizes and shapes to fit a large number of models of Mercedes - BMW - Mazda - Jeep - Chrysler
- Stainless steel body sandblasted
- Plastic handle

L mm	gr	code	
160	425	U04240111	1



### 424 C2

#### Multipurpose scraper

- Plastic handle
- Stainless steel body
- Replaceable blade: length 40 mm, thickness 0,3 mm
- Hanging hole on handle
- Length: 160 mm

gr	code	
310	U04240112	1



### 424 CA2

#### Spare blade for scraper (5 pcs)

code	
U04240113	1



### 424 N/SE7

#### Set for bonded windshields (7 pcs.)

pcs	description	item/size
1	Lever for windshields	424 N1
2	Handle for windshields	424 N2
1	Steel wire for windshields	424 N3
2	Suction cups for transporting and positioning of windshields	424 N4
1	Nylon belt for windshields	424 N5

code	
U04240084	1



### 424 N1

#### Lever for windshields

- To be used together with 424 N2 and 424 N3 for removing windshields

L mm	code	
345	U04240003	1



### 424 N2

#### Handle for windshields

- For car windshield removal

gr	code	
107	U04240004	1



### 424 N3

#### Steel wire for windshields

- For car windshield removal

L m	mm	code	
26	0,7x0,7	U04240005	1



### 424 N4

#### Suction cups for transporting and positioning of windshields

- Adjustable suction cups Ø 117mm for flat and curved surfaces
- Maximum load 80 kg
- Propylene cups for excellent resistance to chemicals
- Polyamide handle and polypropylene body
- Before use, check that the suction cups are clean and has no cracks or damage
- Periodically clean the suction cups with mild detergents
- Do not use pointed or sharp instruments to remove the suction cup from the surface
- Do not use on too coarse, porous, dirty or wet materials
- Do not use with cranes or lifting machinery

Ø mm	load capacity max Kg	L mm	code	
117	80	375	U04240008	1



### 424 N5

#### Nylon belt for windshields

- To be used together with 424 N4 while fitting windshields

L m	belt length mm	code	
4	25	U04240007	1



### 424 TN

#### Windshield wiper arms puller

- For removing wiper arms without damaging the body

ø capacity max mm	code	
44	U04240020	1



### 425

#### Wheel weight pliers

- For fitting and removing wheel balancing weights and for loosening or compressing the retaining springs

L mm	code	
250	U04250001	1



### 425 C

#### Valve extractor

- For disassemble/assemble tyre inflation valves

L mm	code	
123	U04250003	1



### 425 S

#### Valve disassembler with silencer

- To assemble / disassemble the tyre inflation valves
- Reduces air noise in pressures below 85 dB (A)
- Safety against valve expulsion
- Can be used on any type of tyre
- Does not slow down the rate of deflation of the tire

ø gr	code	
10	U04250004	1



### 426 A

#### Trim clip removal pliers

- To extract fasteners securing trims and panels without damaging

L mm	code	
235	U04260002	1



### 426 B/S5

#### Set of 5 tools for plastic elements

- To extract mouldings, fasteners, trim clips from door panels and dashboards
- No damages to plastic parts, gaskets, body

ø gr	code	
275	U04260006	1



### 426 C/S4

#### Set of 4 multi-purpose plastic scrapers

- For removal of counterweights, silicone, plastics, mouldings etc.
- No damage to parts in plastics, gaskets and ceramics
- Can be used with a hammer
- Re grindable with a file
- Length 270 mm
- Blades width 19-22-25-38 mm

ø gr	code	
600	U04260007	1



### 426 D/S4

#### Set of 4 plastic separator scrapers

- To separate timing belt cover, cylinder head engine, drive belt etc.
- Avoid damaging the gasket sealing surface
- Usable with hammer

ø gr	code	
164	U04260005	1



### 426 N

#### Pressure trim clips removal lever

- To extract the fasteners securing trims from panels

L mm	code	
230	U04260001	1



### 426 SAB

#### Airbag service kit (12 pcs.)

- For airbag installation or removal
- Easy access to the airbag fixing screws
- Universal use
- Suitable for the following car models:  
VW Bora, Golf 4, Jetta, Lupo, New Beetle, Passat B5, Polo  
Audi A4, A6  
BMW  
Mercedes-Benz  
Opel  
Renault  
Seat  
Skoda Fabia, Octavia, Superb
- Supplied in plastic case
- Special steel

LxPxH mm	ø gr	code	
275x160x56	820	U04260010	1



### 427

#### Tyre levers

- Double T-section to ensure maximum resistance

L mm	code	
300	U04270001	5
400	U04270002	5
500	U04270003	5
600	U04270004	5



### 428

#### Crowbar

- Model with hexagonal section with one pointed end and one curved flat end
- Chrome Vanadium steel

L mm	a mm	code	
400	23	U04280001	2





429

### Rolling head bar

- Model with round section with one pointed end and one 90° angled nail-claw
- Chrome Vanadium steel
- Varnished execution

L mm	a mm	b mm	code	
400	46	15	U04290001	2



430 C

### Piston ring compressors, ratchet-type

- To hold piston rings steady in their positions while inserting the pistons into the cylinders

n°	L mm	capacity ø mm	code	
1	80	55÷110	U04300010	1
2	80	100÷160	U04300011	1



435 DN

### Timing pulley turner wrench

- For PETROL and DIESEL engines

L mm	code	
440	U04350006	1



435 E/S5

### Set of 5 bihexagonal ring wrenches for belt tension nuts

- Special steel for high resistance
- Quick system to hook/release the wrench to handgrip
- Bihexagonal opening

mm	code	
13-15-16-17-19	U04350011	1



435 FN

### Extractor for timing pulleys

- Adjustable arms, suitable for different diameters

capacity mm	code	
44÷68	U04350009	1



435 M

### Elastic belt kit

- Suited for all types of elastic belts
- Suited to simple pulleys or double diameter pulleys
- Easy use without other tools
- Requires no adjustment for fitting or removing
- Supplied in plastic box
- Metal body

g	code	
100	U04350110	1



435 TBN

### Multi-groove pulley extractor

- Adjustable claws
- Groove pitch: 3,56 mm.

capacity mm	code	
45÷175	U04350031	1



435 V

### Universal pulley block

- For PETROL and DIESEL engines
- To hold timing pulleys of engines with single or double camshaft and for diesel injection pumps

LxPxH mm	code	
270x185x90	U04350040	1



437

### Piston ring pliers

- Model with specially shaped jaws for assembling and disassembling piston rings

n°	capacity ø mm	code	
1	55÷100	U04370102	1
2	80÷120	U04370103	1
3	110÷160	U04370104	1



438/1

### Valve lifter clamp

- For fitting and removing valve springs
- Screw adjustment model, straight clamps

capacity mm	L mm	code	
75÷225	380	U04380001	1



438 N

### Slide-hammer valve lifter

- For removing valve springs
- The slide hammer is used to free split collets

capacity mm	L mm	code	
130	390	U04380003	1



438 NA1

### Collet clamp for engines 16V

- For use with valve lifters 438 N

g	code	
75	U04380003Q	1



438 P

### Pneumatic tool for assembling and disassembling engine valves

- Universal (PETROL and DIESEL engines)
- Max push: 75 Kg at 6 bar, 100 Kg at 8 bar
- Supplied in plastic case 480x380x135 mm

capacity mm	code	
250	U04380006	1



439 M

### Valve grinder

- Suction pads Ø 19 and 22 mm

L mm	code	
225	U04390003	1



**439 P**

**Pneumatic valve grinder**

- Air supply pressure 8 bar
- Adjustable oscillation rate: 250÷3000/min
- Supplied with 3 suction pads: Ø 22, 33, 45 mm



Ø gr	code	
800	U04390010	1



**439 PA**

**Suction pads**

- To be used together with 439 P



Ø mm	Ø1 mm	code	
22	6,8	U04390010Q	1
33	6,8	U04390012Q	1
45	6,8	U04390013Q	1



**441/1**

**Brake spring pliers**

- For attaching or detaching the retracting springs of drum brakes with riveted brake-shoes on cars



L mm	code	
220	U04410001	1



**441/2**

**Brake spring pliers**

- For attaching or detaching the retracting springs of drum brakes with bounded brake-shoes on cars
- Hinged anchor-plate



L mm	code	
345	U04410002	1



**441/3**

**Brake spring pliers**

- For attaching or detaching the retracting springs of drum brakes with bonded brake-shoes on industrial vehicles
- Knurled and hinged anchor-plate



L mm	code	
490	U04410003	1



**441 F**

**Hand-brake pliers**

- For easy hook-up of hand-brake cable



L mm	code	
230	U04410005	1

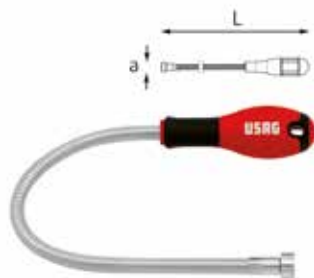

**442 N**

**Flexible retrievers with magnetic head**

- To retrieve metal pieces in hard to reach places

n°	capacity max Kg	a mm	L mm	code	
0	0,4	8	465	U04420004	2
1	1,4	12	525	U04420005	2
2	4	19	525	U04426006	2



**442 AN**

**Spare magnets**

- For flexible retrievers 442 N

n°	code	
0	U04420030Q	5
1	U04420031Q	5
2	U04420032Q	5



**442 T**

**Telescopic retriever with articulated magnet**

- For recovering magnetizable items from inaccessible places
- Brass rod with pocket clip

L mm	capacity max gr	a mm	code	
630	700	18	U04420011	1



**443 B**

**Metallic strap wrench for oil filters (cars)**

capacity Ø mm	L max mm	code	
65±105	290	U04430013	1



**443 BA**

**Spare strap**

- For metallic strap wrenches 443 B



capacity Ø mm	code	
65±105	U04430013Q	1



**443 BC**

**Metallic strap wrench for oil filters (industrial vehicles)**

capacity Ø mm	L max mm	code	
105±145	300	U04430015	1



**443 BCA**

**Spare strap**

- For metallic strap wrenches 443 BC



capacity Ø mm	code	
105±145	U04430015Q	1



**443 F**  
Metallic strap wrench for oil filters

capacity ø mm	L max mm	code	
80÷110	235	U04430003	1



**443 N**  
Fast oil-filter wrench (cars)

- Automatic belt clamping
- Lever to increase clamping power for perfect grip on the filter
- Articulated jaws for gripping the filter and having a ratchet effect
- Stainless steel strap
- Handle (160 mm) in high resistant plastic material (hydrocarbons, bumps)
- Capacity: Ø 66÷105 mm

capacity ø mm	L max mm	code	
66÷105	290	U04430005	1



**443 NA**  
Spare strap

- For strap wrenches 443 N

capacity ø mm	code	
66÷105	U04430011Q	1



**443 NC**  
Fast oil-filter wrench (industrial vehicles)

- Automatic belt clamping
- Lever to increase clamping power for perfect grip on the filter
- Articulated jaws for gripping the filter and having a ratchet effect
- Stainless steel strap
- Handle (160 mm) in high resistant plastic material (hydrocarbons, bumps)
- Capacity: Ø 106÷150 mm

capacity ø mm	L max mm	code	
106÷150	345	U04430007	1



**443 NCA**  
Spare strap

- For strap wrenches 443 NC

capacity ø mm	code	
106÷150	U04430017Q	1



**444**  
Strap wrench for oil filters

capacity ø mm	L mm	code	
60÷140	225	U04440001	5



**444 A**  
Spare strap

- For strap wrenches 444

capacity ø mm	code	
60÷140	U04440101	5



**445**  
Articulated chain wrench for oil filters

capacity ø mm	L mm	code	
60÷110	225	U04450001	1



**445 A**  
Spare chain

- For chain wrenches 445

capacity ø mm	code	
60÷110	U04450002	1



**445 B**  
Oil-filter wrench - big diameters

- 8-position model
- Jaws with "triangle" teeth for enhanced filter tightening
- Steel body
- Handles sheathed in PVC
- Sandblasted enamelled finish
- Burnished finish

capacity ø mm	L mm	code	
95÷178	500	U04450015	1



**443 N**

Fast oil-filter wrench



Capacity  
ø 66÷105 mm



**Self-regulating steel strap**  
It adapts automatically to the diameter of the filter.



**Ratchet mechanism**  
Rapidity and ease of use even in narrow spaces.



1/2

### 445 K

#### Chain wrench for oil filters (with socket)

capacity Ø mm	code	
50÷110	U04450010	1



3/8

### 446

#### Cap wrenches for oil filters

n°	sides	code	
65	14	U04461030	1
66,5	14	U04461031	1
74	8	U04461034	1
74A	14	U04461035	1
74B	15	U04461036	1
79	15	U04461039	1
89	15	U04461041	1
92A	15	U04461044	1



3/8

### 446 A

#### Self-gripping oil-filter wrench (cars)

capacity Ø mm	code	
65÷120	U04460003	1



1/2

### 446 C

#### Self-gripping oil-filter wrench (industrial vehicles)

capacity Ø mm	code	
95÷165	U04460005	1



3/8

### 446 DA/SE2

#### Set of 2 cup wrenches for oil filters

- Allows the re-tightening at the original torque (value indicated on the plastic cap)
- 3/8" square drive
- Steel body
- Set for BMW, Volkswagen, Skoda, Audi, Seat, Mercedes
- Profile dimensions: Ø 74 mm x 14 sides - Ø 86 mm x 16 sides

kg	code	
500	U04461100	1



3/8

### 446 DA/SE6

#### Set of 6 cup wrenches for oil filters

- Allows the re-tightening at the original torque (value indicated on the plastic cap)
- 3/8" square drive
- Steel body
- Set for Fiat, Lancia, Alfa Romeo, BMW, Renault, Volkswagen, Skoda, Audi, Seat, Mercedes
- Profile dimensions: Ø 74 mm x 14 sides - Ø 75 mm x 16 sides - Ø 86 mm x 16 sides - Ø 102 mm x 14 sides - Ø 66 mm x 18 sides - Ø 96 mm x 18 sides

kg	code	
1,5	U04461104	1



3/8

### 446 DC

by FACOM

#### Cap wrenches with hexagonal profile for oil filter covers

- Compact dimensions, ideal to work in narrow spaces
- Reduces the risk of damage to the oil filter covers

Ø mm	b mm	L mm	code	
24	34	30	U04461224	1
27	38	30	U04461227	1
30	40	30	U04461230	1
32	44	30	U04461232	1
36	50	30	U04461236	1
38	52	30	U04461238	1



3/8

### 446 DT/S2

#### Set of two cap wrenches for oil filter covers - Japanese cars

- Specific for removing the oil filter covers on Toyota, Lexus, Daihatsu, Subaru engines
- Can also be used to remove the Toyota oil filter cartridge
- Reduces the risk of damage to the oil filter covers
- 3/8" square drive; 27 mm hexagon
- Can also be used for tightening with a torque wrench
- Body in phosphatized Aluminum
- 446 DT1

Profile dimensions: Ø 64,5 mm x 14 sides  
Overall dimensions: (Øxh): 80x49 mm

- 446 DT2

Profile dimensions: Ø 64,5 mm x 14 sides  
Overall dimensions: (Øxh): 86x49 mm

kg	code	
450	U04461203	1



3/8



### 446 E

#### Self-gripping oil filter wrenches

- 3/8" square drive
- Automatic adjustment of the filter diameter with a simple push
- Possibility to be used for both tightening and untightening
- Allows frontal access to the oil filter
- Ideal for filters difficult to reach

capacity Ø mm	code	
60÷80	U04460012	1
80÷100	U04460013	1
100÷120	U04460014	1



3/8



### 446 E/SE2

#### Set of 2 self-gripping oil filter wrenches

- 446 E/60÷80-80÷100
- 3/8" square drive
- Automatic adjustment of the filter diameter with a simple push
- Possibility to be used for both tightening and untightening
- Allows frontal access to the oil filter
- Ideal for filters difficult to reach

pcs	description	item/size
2	Self-gripping oil filter wrenches / 60÷80-80÷100	446 E

kg	code	
0,5	U04460015	1



**446 H**

**Fuel gauge remover**

- Opening regulation by baffle plate
- Three driving "forks" to transmit the right coupling without any damage to the plastic ring-nut
- Compact and adjustable "forks" to work in narrow spaces and to adapt the tool on new vehicles

capacity Ø mm	code	
88÷170	U04460008	1



**1/2**

**446 M**

**Tool for Multijet diesel filter**

- Supplied with:
- 1/2" drive for torque wrench
- Adapter for bench vice

kg	code	
525	U04460011	1



**1/2**

**446 RT**

by **FACOM**

**Cap wrench for oil filters TRUCK**

- Specific for removing the oil filters of RENAULT and VOLVO trucks
- 1/2" square drive; 36 mm hexagon
- Profile dimensions: Ø 106 mm x 15 sides
- Body in Aluminum

code	
U04461206	1



**3/8**

**446 S28**

**Set of 30 oil-filter cap wrenches**

- Set with 28 oil-filter cap wrenches with 3/8" square drive, 1 adapter 3/8"-1/2", 1 self-gripping wrench with 3/8" square drive (capacity 65÷120 mm)
- The set is suitable for the majority oil filters fitted on the following car brands: FIAT, ALFA, LANCIA, PEUGEOT, RENAULT, VOLKSWAGEN, AUDI, SEAT, SKODA, BMW, MERCEDES, VOLVO, SAAB, ROVER, JAGUAR, LOTUS, TOYOTA, SUZUKI
- Sizes of the oil-filter cap wrenches (Ø x N ° sides): 66/6 - 65/14 - 65/67 - 68/14 - 73/14 - 74/15 - 74/76 - 75/77 - 76/12 - 76/14 - 76/30 - 76/8 - 78/15 - 80/15 - 80/82 - 86/16 - 86/18 - 90/15 - 92/10 - 93/15 - 93/36 - 93/45 - 95/15 - 96/18 - 100/15 - 106/15 - 108/15 - 108/18
- Carbon steel body, burnished finish
- Supplied in plastic case with carrying handle and closing clip

LxPxH mm	kg	code	
620x500x70	7	U04461204	1



**3/8**

**446 T**

**Cap wrenches for oil filters and diesel Purflux**

Ø filter mm	points	code	
66	6	U04461016	1
76	12	U04461018	1
86	18	U04461020	1
96	18	U04461022	1



**447**

**Pressers for shock absorber springs**

- For fitting or disassembling coil springs on car shock absorbers
- Double hook and anti-slip locking screw

capacity min-max mm	L mm	code	
270	365	U04470000	1



**447 T**

**2006/42/CE**

**Universal pneumatic shock absorber dismantler**

- Ideal for cars
- Self-levelling system of the two upper arms: also fits into conical and disaligned springs
- Self-lubricating: no lubrication and/or greasing necessary on the sliding columns
- Supplied with lower brackets 447 TC1 (78÷130 mm) and 447 TC2 (105÷182 mm), vice 447 TA and universal upper clamps 447 TB1
- Compact dimensions for easy installation in the shop 470x450x1390 mm
- Complies with MACHINE DIRECTIVE 2006/42/CE

characteristics	size
Compression power	735 kg (6 bar), 1226 kg (10 bar)
Recommended air pressure (bar)	6÷10
Piston stroke (mm)	420
Cylinder	Aluminium alloy and nylon resin
Lower brackets/vice	Quick coupling/release

LxPxH mm	kg	code	
470x450x1390	60	U04470101	1



**447 TB2**

**Upper clamps for HONDA and TOYOTA cars**

kg	code	
1	U04470103Q	1



**447 TF**

**Kit for MERCEDES**

- Composed by upper bracket and average bracket pressing the spring (105÷182 mm)

kg	code	
1,4	U04470111Q	1



### 447 TG

#### Upper Bracket for PORSCHE CAYENNE, VW TOUAREG



Kg	code
3,2	U04470112Q 1



### 448 M

#### Lever for removing suspension uprights/arms



- For quick and safe disassembly of MAC PHAERSON suspension uprights and spherical articulations
- 5-position adjustable hook: precision and easy use
- Length 120 cm
- Spare hook: code DSL.40A-1

L mm	Kg	code
1200	5,2	U04480010 1



### 449

#### Ball-joint extractors



- For extracting ball joints from steering wheel and suspensions

capacity ø mm	a mm	code
16	45	U04490002 1
22	45	U04490001 1
32	80	U04490003 1



### 449 V

#### Spare screw

- For ball-joint extractors 449

n°	LxPxH mm	L mm	code
1-2	M14x1,5	73	U04490060Q 1
3	M22x1,5	102	U04490061Q 1



### 449 VM

#### Spare working screw

- For ball-joint extractors 449

n°	LxPxH mm	L mm	code
1-2	M14x1,5	60	U04490062Q 1



### 449 SP

#### Spare safety pin

- For ball-joint extractors 449

n°	LxØ mm	code
1-2	32x7	U04490064Q 1
3	42x7	U04490065Q 1



### 449 A

#### Tool to assemble/disassemble axial articulations



- To work without interventions on steering box
- Manual use, hexagonal connection 30 mm
- Capacity: Ø 35÷45 mm
- Inside rolls automatically regulate grip on the articulation
- Steel body

capacity ø mm	L mm	Kg	code
35÷45	420	1,8	U04490050 1



### 449 ID

#### Hydraulic ball joints separator



- For extracting ball-joints from steering wheel and suspensions on industrial vehicles

capacity max ø mm	power ton	a mm	code
36	8	65	U04490009 1



### 449 IDA

#### Ball joints separator

by FACOM

- Mechanical screw model
- For extracting ball-joints from steering wheel and suspensions on industrial vehicles
- Hexagonal drive: 36 mm

capacity max ø mm	code
36	U04490019 1



### 449 TA

#### Ball-joint extractors for industrial vehicles

- For removing steering and suspension ball-joints
- Hexagonal drive 22 mm

a mm	b mm	c mm	code
23,2	70	94,5	U04490010 1



### 449 TB

#### Ball-joint extractors for industrial vehicles

- For removing steering and suspension ball-joints
- Hexagonal drive 22 mm

a mm	b mm	c mm	code
25,2	70	94,5	U04490015 1



### 449 TC

#### Ball-joint extractors for industrial vehicles

- For removing steering and suspension ball-joints
- Square drive 3/4"

a mm	b mm	c mm	code
42,5	105	144	U04490021 1



## 450

### Puller for wheel hubs

- Model with five oscillating removable legs for detaching wheel hubs from cars

capacity max $\theta$ mm	depth max mm	code	
225	110	U04500002	1



## 451 N/S4

### Outside puller with three jaws

- Model with self-locking jaws
- Safety pin
- Working screw with 18 mm hexagonal drive
- Possibility of using with two jaws
- Carbon steel pressure screw
- Chrome Vanadium steel body
- Chrome plated and burnished finish
- Working screw M16x2
- Spare safety pins: U.306- 24J3

pcs	description	item/size
1	Outside pullers with three jaws	451 N/1
3	Spare jaws	451 NTA/1

power t	code	
3	U04510100	1



## 451 N

### Outside pullers with three jaws

- Model with self-locking jaws
- Safety pin
- Working screw with 18 mm hexagonal drive
- Possibility of using with two jaws
- Carbon steel pressure screw
- Chrome Vanadium steel body
- Chrome plated and burnished finish
- Working screw M16x2
- Spare safety pins (for all models): U.306-24J3

n°	power t	a mm	b mm	code	
1	3	7÷140	147	U04510005	1
2	4	10÷180	200	U04510006	1
3	4	20÷260	250	U04510007	1

## 451 NA

### Spare jaws

- For pullers 451 N

n°	code	
1	U04510001Q	1
3	U04510003Q	1



## 451 NB

### Spare screws

- For pullers 451 N, 451 NT

n°	code	
1	U04510012Q	1
2-3	U04510013Q	1



## 451 NT

### Inside pullers with three jaws

- Model with self-locking jaws
- Safety pin
- Working screw with 18 mm hexagonal drive
- Possibility of using with two jaws
- Carbon steel pressure screw
- Chrome Vanadium steel body
- Chrome plated and burnished finish
- Extraction capacity for 451 NT1 (23÷55mm) and for 451 NT2 (30÷55mm) only if combined with beating mass 468 E2
- Working screw M16x2

n°	a mm	b mm	code	
1	23÷130	140	U04510015	1
2	30÷170	190	U04510016	1



## 451 NTA

### Spare jaws

- For pullers 451 NT

n°	code	
1	U04510007Q	1
2	U04510008Q	1



## 454

### Outside pullers with two jaws

- Model with sliding jaws
- Bar with tightening hexagon
- Jaws with small claws
- Carbon steel pressure screw
- Chrome Vanadium steel
- Chrome plated and burnished finish

n°	a mm	b mm	power t	$\theta$ mm	code	
0	65	70	1,5	13	U04540000	1
1	90	110	3	17	U04540010	1
2	130	110	3	17	U04540020	1
3	175	165	4	17	U04540030	1
4	220	165	4	17	U04540040	1
5	270	220	5	21	U04540050	1
6	340	220	5	21	U04540060	1

## Pullers 451 N and 451 NT safety and simplicity of use

The innovative self-centering and self-tightening system allows for easier positioning and greater speed as well as added simplicity of use. Should the maximum torsion level be exceeded, the breaking of a metal pin guarantees the safety of the user and the tool.

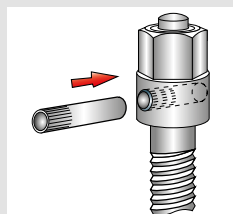
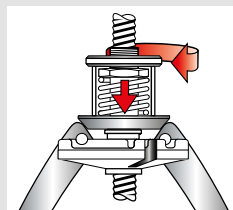



### 454 SE3

#### Set of 3 outside pullers with two jaws

- 454 N 0-1-2
- Model with sliding jaws
- Bar with tightening hexagon
- Jaws with small claws
- Carbon steel pressure screw
- Chrome Vanadium steel
- Chrome plated and burnished finish

pcs	description	item/size
3	Outside pullers with two jaws	454/0-1-2

kg	code	item/size
2,7	U04549002P	1

### 454 A



#### Spare jaws

- For pullers 454



n°	L mm	b mm	code	item/size
0	100	70	U04540001Q	1
1-2	153	110	U04540011Q	1
3-4	227	165	U04540031Q	1
5-6	302	220	U04540051Q	1

### 454 B



#### Spare screws

- For pullers 454

n°	L mm	Ø mm	code	item/size
0	130	M12x1,75	U04540002Q	1
1-2	180	M16x2	U04540012Q	1
3-4	280	M20x2,5	U04540032Q	1
5-6	340	M27x3	U04540052Q	1



### 454 S7

#### Set of 7 pullers

- Supplied with sheet steel display stand
- Model with sliding jaws
- Bar with tightening hexagon
- Jaws with small claws
- Carbon steel pressure screw
- Chrome Vanadium steel
- Chrome plated and burnished finish

pcs	description	item/size
7	Outside pullers with two jaws/ 0-1-2-3-4-5-6	454
1	Empty metal display stand	454 N/SV7

kg	code	item/size
21	U04540100	1



### 454 N/SV7

#### Empty metal display stand

- For pullers 454 S7

kg	code	item/size
1,7	U04540100Q	1



### 458

#### Conical extractors for broken bolts and stud bolts

- For removing broken stud bolts without surface to grip
- Special Chrome Vanadium steel
- Satin and burnished finish

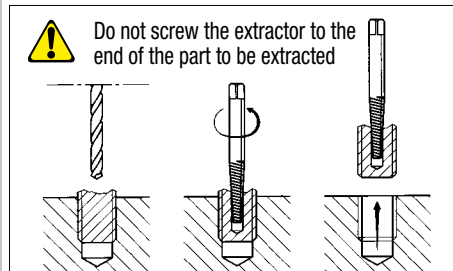

n°	M	Ø hole mm	Ø mm	a mm	code	item/size
1	4÷5	3,25	2,7	3	U04580001	5
2	6÷7	4,5	3,9	3,3	U04580002	5
3	8÷10	5	4,4	4,5	U04580003	5
4	11÷14	6,5	5,3	5	U04580004	5
5	16÷18	8,5	7	6,6	U04580005	5
6	18÷24	11,5	9,4	9,3	U04580006	5
7	24÷33	15	10,4	10,3	U04580007	5
8	33÷45	19	13,8	14,3	U04580008	5



### 458 S5

#### Set of 5 conical extractors

- 458/1-2-3-4-5
- For removing broken stud bolts without surface to grip
- Special Chrome Vanadium steel
- Satin and burnished finish
- Supplied in plastic box

pcs	description	item/size
5	Conical extractors for broken bolts and stud bolts	458/1-2-3-4-5

LxPxH mm	kg	code	item/size
140x133x47	125	U04580011	1



### 458 S6

#### Set of 6 conical extractors

- 458/1-2-3-4-5-6
- For removing broken stud bolts without surface to grip
- Special Chrome Vanadium steel
- Satin and burnished finish
- Supplied in plastic box

pcs	description	item/size
6	Conical extractors for broken bolts and stud bolts/1-2-3-4-5-6	458

LxPxH mm	kg	code	item/size
140x133x47	230	U04580012	1



### 458 S8

#### Set of 8 conical extractors

- 458/1-2-3-4-5-6-7-8
- For removing broken stud bolts without surface to grip
- Special Chrome Vanadium steel
- Satin and burnished finish
- Supplied in plastic box

pcs	description	item/size
7	Conical extractors for broken bolts and stud bolts/1-2-3-4-5-6-7-8	458

LxPxH mm	kg	code	item/size
205x143x47	720	U04580013	1



### 458 B

#### Pullers for damaged nuts and screws

- Helicoidal conic flower profile
- Exceptional grip on damaged nuts
- High resistance steel
- Phosphatized finish
- Square drive 3/8" (8-10-11-12-13-14mm)
- Square drive 1/2" (15-16-17-18-19mm)
- Length 32mm

Ø mm	"	b mm	code	item/size
8	3/8	12,5	U04580108	1
10	3/8	15	U04580110	1
11	3/8	16,5	U04580111	1
12	3/8	18	U04580112	1
13	3/8	19	U04580113	1
14	3/8	20,5	U04580114	1
15	1/2	22,5	U04580125	1
16	1/2	23,5	U04580126	1
17	1/2	25,5	U04580127	1
18	1/2	26,5	U04580128	1
19	1/2	27,5	U04580129	1





1/4

### 458 E/B9

#### Set of grip bits for damaged hexagonal screws (9 pcs.)

- Size: 2-2,5-3-4-5-6-7-8 mm
- Exclusive special profile
- The special design of the grip bits allows you to grip the hexagons recessed in any condition: intact or completely damaged
- Special steel with phosphated finish
- Including 1/4-1/4" bit holding socket
- Supplied in a compact fabric pouch



pcs	description	item/size
8	Set of grip bits for damaged hexagonal screws (9 pcs.)/2-2,5-3-4-5-6-7-8	458 E/SE8

LxPxH mm	code	
110x105x20	U04580313	1



### 458 E/SE8

#### Set of grip bits for damaged hexagonal screws (9 pcs.)

- Sizes: 2-2,5-3-4-5-6-7-8
- Exclusive special profile
- The special design of the grip bits allows you to grip the hexagons recessed in any condition: intact or completely damaged
- Special steel with phosphated finish



code	
U04580314	1



### 458 S20

#### Assortment of grip sockets and bits for damaged hexagonal screws and nuts (20 pcs.)

- Composed of grip sockets and bits for external or recessed hexagonal profiles
- They allow you to unscrew screws and hexagonal nuts, even if extremely damaged
- Special steel with phosphated finish
- 458 B: grip sockets with 3/8 or 1/2" connection and conical helicoidal profile
- 458 E: grip bits with 1/4" connection and exclusive special profile
- 1/4-1/4" bit holding socket included
- High resistance ABS case
- Inner foam module



pcs	description	item/size
11	Pullers for damaged nuts and screws / 8-10-11-12-13-14-15-16-17-18-19	458 B
8	Set of grip bits for damaged hexagonal screws (9 pcs.)/2-2,5-3-4-5-6-7-8	458 E/B9
1	Empty ABS case - size S	606 S
1	Bit-holder sockets	684/1/4

LxPxH mm	code	
210x130x60	U04580312	1



### 459

#### Cam-type puller for stud bolts

- Model with female square drive 1/2" for inserting or extracting stud bolts
- Special Chrome Vanadium steel
- Chrome plated and burnished finish

capacity ø mm	axb mm	code	
5÷20	52x54	U04590001	1



### 459 A

#### Spare roller

- For pullers 459

ø gr	code	
60	U04590011	1



### 459/1

#### Roller-type pullers for stud bolts

- For inserting or extracting stud bolts without damaging the threads
- 1/2" female square drive
- Hexagonal drive 22 mm
- Special Chrome Vanadium steel
- Chrome plated finish

M	a mm	L mm	code	
6	25	65	U04590012	1
7	25	65	U04590013	1
8	25	65	U04590014	1
10	29	75	U04590016	1
12	29	75	U04590019	1
14	34	75	U04590021	1
16	34	75	U04590023	1



### 459/1 S4

#### Set of 4 roller-type pullers

pcs	description	item/size
4	Roller-type pullers for stud bolts / M6-M8-M10-M12	459/1

code	
U04590183	1

## GRIP BITS 458 E:

## ALSO EFFECTIVE ON EXTREMELY DAMAGED SCREWS



1/4

1/4



YouTube



### EXCLUSIVE PROFILE

The special design of the grip bits allows you to grip the hexagons recessed in any condition: intact or completely damaged.

### DAMAGED SCREWS

When a screw with a hexagon socket-head is damaged, it is no more possible to unscrew it with normal hexagonal male keys. The new 458 E grip bits allow to unscrew even screws extremely damaged, up to 98% of the hexagonal profile.





## 460 A

### Set of extractors for stud bolts

- Supplied in plastic box
- Capacity:  $\varnothing 6\div 14$  mm
- Contents:
  - 885.F1: drill  $\varnothing 3,2$  mm
  - 885.F2: drill  $\varnothing 4,8$  mm
  - 885.F3: drill  $\varnothing 6,3$  mm
  - 885.F4: drill  $\varnothing 7,9$  mm
  - 885.F5: drill  $\varnothing 9,7$  mm
  - 885.EH1: puller  $\varnothing 6,3$  mm
  - 885.EH2: puller  $\varnothing 7,9$  mm
  - 885.EH3: puller  $\varnothing 9,5$  mm
  - 885.EH4: puller  $\varnothing 11,1$  mm
  - 885.EH5: puller  $\varnothing 12,7$  mm

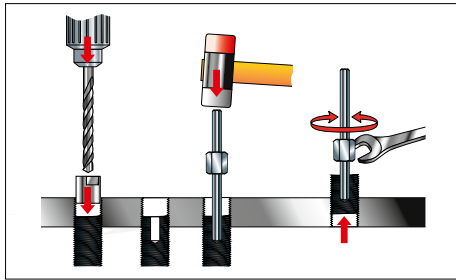

LxPxH mm	code	
165x130x25	U04600080	1



## 462

### Outside puller with two jaws

- Model with oscillating jaws and self-tightening spring
- Carbon steel pressure screw and body
- Zinc Chrome plated and burnished finish

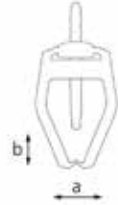

by FACOM

a mm	b mm	code	
10÷80	90	U04620001	1



## 466 N

### Hydraulic jack

- Universal model to insert between the pressure screw of the puller and the hub when developing high force is required
- Safety pin against accidental overload (breaking load 110 Nm)
- Carbon steel body
- Zinc Chrome plated and burnished finish

t	axL mm	$\varnothing$ mm	code	
30	35x260	19	U04660002	1

## Hydraulic jack 466 N

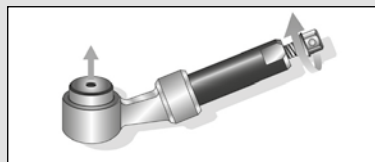

### Piston Output

When the allowed torsion is exceeded, the safety pin breaks

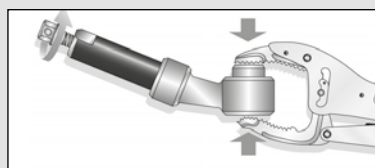
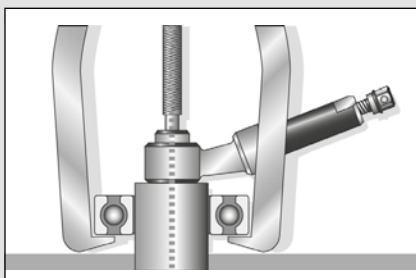

### Piston repositioning

Release the pressure by unscrewing and repositioning the piston using lock-grip pliers or a vice

### Usage

Correctly align the load and secure a good axis



## 468 C

### Inside expansion pullers

- Conically expanding model for use in combination with support 468 D or slide hammer 468 E
- Special Chrome Vanadium steel
- Burnished finish

n°	a mm	b mm	$\varnothing$ mm	code	
1	( $\varnothing 6,5\div 8$ )	M8	12	U04680011	1
2	( $\varnothing 8,5\div 10$ )	M8	12	U04680012	1
3	( $\varnothing 10\div 13$ )	M8	12	U04680013	1
4	( $\varnothing 13\div 18$ )	M8	12	U04680014	1
5	( $\varnothing 18\div 22,5$ )	1/2"	17	U04680015	1
6	( $\varnothing 22,5\div 30$ )	1/2"	17	U04680016	1
7	( $\varnothing 30\div 38$ )	1/2"	22	U04680017	1
8	( $\varnothing 38\div 50$ )	1/2"	32	U04680018	1
9	( $\varnothing 50\div 60$ )	1/2"	32	U04680019	1



## 468 D

### Supports for expansion pullers

- Model with sliding legs for use in combination with pullers 468 C
- Carbon steel pressure screw and legs
- Special Chrome Vanadium steel body
- Zinc Chrome plated and burnished finish
- 468 D2 and D3 supplied with adapter 468 F1 (M16 1/2")

n°	468 C	a mm	b mm	code	
1	1÷4	30÷100	M8	U04680025	1
2	5÷9	40÷110	M16	U04680026	1
3	5÷9	70÷200	M16	U04680027	1



## 468 E

### Slide hammers

- For use in combination with pullers 468 C
- Carbon steel body
- Chrome plated and burnished finish
- 468 E2 supplied with adapter 468 F1 (M16 1/2")

n°	468 C	b mm	mass Kg	code	
0	1÷4	M8	0,2	U04680031	1
1	5÷9	1/2"	1	U04680032	1
2	5÷9	M16	1,6	U04680033	1



### 468 F1

#### Adapter for slide hammers 468 D2 - 468 D3 - 468 E2

- Female thread M16
- Male thread 1/2"

code	img
U04680027Q	1



### 468 NKS7

#### Assortment with expansion pullers in sheet steel case (7 pcs.)

- Empty inner foam module: code U05190984Q

pcs	description	item/size
5	Inside expansion pullers / 3-4-5-6-7	468 C
2	Supports for expansion pullers	468 D/1-3
1	Adapter for slide hammers 468 D2 - 468 D3 - 468 E2	468 F1
1	Sheet steel box (empty) - size XL	612 XL
1	Foam module empty	519 M 468NKS11V

LxPxH mm	kg	code	img
425x395x83	6	U04680102	1



### 468 NKS11

#### Assortment with expansion pullers in sheet steel case (11 pcs.)

- Empty inner foam module: code U05190984Q

pcs	description	item/size
9	Inside expansion pullers / 1-2-3-4-5-6-7-8-9	468 C
2	Supports for expansion pullers	468 D/1-3
1	Adapter for slide hammers 468 D2 - 468 D3 - 468 E2	468 F1
1	Sheet steel box (empty) - size XL	612 XL
1	Foam module empty	519 M 468NKS11V

LxPxH mm	kg	code	img
425x395x83	10	U04680103	1



### 468 M

#### Bearings and seals drivers

- It simplifies the insertion of external rings for angular ball bearings
- Axis, bearing seat and sealing rings are not damaged
- Adjustable ring in 3 positions
- Steel handle
- It can be used on most vehicles, including motorcycles



a mm	L mm	code	img
9,50÷50	176	U04680150	1
18÷90	210	U04680151	1

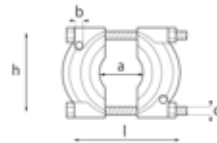

### 472 AN

#### Separators

- For extracting parts which do not allow use of traditional extractors. Inserted between the object and its seat, creates distance between the parts. The extraction can then be completed by connecting the separator to a bar-type puller 472 N
- Special Chrome Molybdenum steel presson screws
- Special Chrome Molybdenum steel body
- Chrome plated finish
- Spare screws:
  - n°1: U.53T1-02
  - n°2: U.53T2-02
  - n°3: U.53T3-02
  - n°4: U.53T4-02
  - n°5: U.53T5-02

n°	a mm	b mm	c mm	LxH mm	code	img
1	5÷60	M10	M12	140x91	U04720011	1
2	15÷110	M16	M16	215x153	U04720012	1
3	15÷150	M20	M20	290x204	U04720013	1
4	20÷180	M22	M22	360x289	U04720014	1
5	25÷250	M22	M22	430x316	U04720015	1

#### Bearing separators 472 AN fit behind the part to be pulled out, when the jaw ends of conventional pullers cannot pass.

- The wedge-shaped jaws close and separate the piece using the back surface as support base.
- The separators are used with mechanical screw pullers or with pullers specially developed for use with manual jacks with hydraulic mechanism.

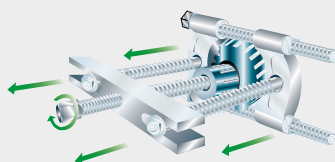
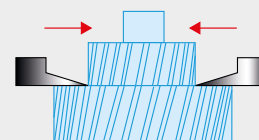

#### Mechanical screw separator and puller

**SAFETY**

For extractions with separators and pullers do not use impact wrenches.

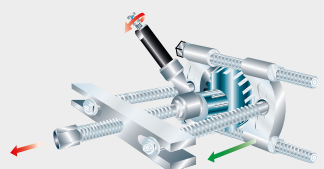

#### Separator and puller with manual hydraulic assistance

- Puller used with 466 N hydraulic jack
- To be used only with pullers and separators 472 AN (4-5) and 472 N (4-5)



## 472 N

### Bar-type pullers for separators

- Model with sliding legs for use in combination with separators 472 AN
- Supplied with two Chrome plated inserts, nuts and washers
- Special Chrome Molybdenum steel presson screws
- Special Silicon-Manganese steel body
- Chrome plated finish
- Spare inserts:  
n°1: U.53R1L  
n°2: U.53R2L  
n°3: U.53R3L  
n°4-5: U.53R4LA

n°	a mm	b mm	c mm	d mm	e mm	L mm	code	
1	40-110	180	M10	11	M16	135	U04720001	1
2	70-200	240	M16	11	M16	220	U04720002	1
3	75-280	300	M20	21	M27	320	U04720003	1
4-5	145-400	350	M22	25	M33	450	U04720004	1



## 485

### Clutch disk aligner

- Supplied with three expansion pliers 485 R (A-B-C)

capacity mm	code	
14,5±25	U04856001	1



## 485 R

### Spare expansion pliers

- For clutch disk aligner 485

n°	capacity mm	code	
A	14,5-18	U04850003	1
B	18-21	U04850004	1
C	22-25	U04850005	1



## 490

### Nut splitters

- For splitting and removing seized nuts without damaging the screws
- Carbon steel wedge
- Special Chrome Vanadium steel body
- Chrome plated and burnished finish

n°	Ø mm	a mm	Ø mm	code	
1	5÷10	22	12	U04900001	2
2	8÷16	30	14	U04900002	2
3	16÷24	45	19	U04900003	2
4	19÷27	57	21	U04900004	2



## 493 A

EN 1492-1

### Two-ply webslings

- Safety coefficient 7:1
- Combination of colours and raising power according to the norms EN 1492-1

power max ton	colour	L m	code	
1		2	U04930002	1
1		3	U04930003	1
1		4	U04930004	1
1		5	U04930005	1
1		6	U04930006	1
2		2	U04930012	1
2		3	U04930013	1
2		4	U04930014	1
2		5	U04930015	1
2		6	U04930016	1
3		2	U04930022	1
3		3	U04930023	1
3		4	U04930024	1
3		5	U04930025	1
3		6	U04930026	1



## 493 B

EN 1492-1

### Roundslings

- Structure with wear resistant sheath
- Safety coefficient 7:1
- Combination of colours and raising power according to the norms EN 1492-2

power max ton	colour	L m	code	
1		1	U04930052	1
1		1,5	U04930053	1
1		2	U04930054	1
1		2,5	U04930055	1
1		3	U04930056	1
2		1	U04930062	1
2		1,5	U04930063	1
2		2	U04930064	1
2		2,5	U04930065	1
2		3	U04930066	1
3		1	U04930072	1
3		1,5	U04930073	1
3		2	U04930074	1
3		2,5	U04930075	1
3		3	U04930076	1



## 493 C

EN 12195-2

### Anchorage belt

- Belt width 35÷50 mm
- Ratchet-type tensioner 35÷50 mm
- Anchorage charge 1000÷2000 N
- Hook for codes U04930102, U04930103, U04930104
- Double hook for code U04930106
- Reference norm EN 12195-2

L mm x m	load N	code	
35x4	1000	U04930102	1
35x6	1000	U04930103	1
50x8	2000	U04930104	1
50x10	2000	U04930106	1

# PLASTIC TRAYS RANGE



519/285A1 519/324H 519/127N



519/382F 519/613CEA 519/150AX



## 495 BA

### Basic assortment (74 pcs.) - 2 drawers

- Supplied with plastic trays



pcs	description	item/size
4	Pliers for circlips (19÷60)	519/127N
5	Universal pliers, adjustable pliers, cutting nippers, extra-long nose pliers, lock-grip pliers	519/150AX
25	Combination wrenches (6÷24), angled hexagon keys (1,5÷10)	519/285A1
10	Screwdrivers for slot-head and PHILLIPS® screws	519/324H
8	Chisel, pin punch (2x100-3x130-4x145-5x165), centre punch, mallet, hammers	519/382F with graphite handle
22	Hexagonal sockets, ratchet 237 A 1/2" and accessories (1/2")	519/613CEA

kg	code	1
10,5	U04950002	1



519/285A1 519/285B2 519/150AX



519/280T



519/324H 519/127N 519/613CEA



519/200I



519/234C 519/276



## 495 A2

### Assortment for car repair (119 pcs.) - 5 drawers

- Supplied with plastic trays



pcs	description	item/size
4	Pliers for circlips (19÷60)	519/127N
5	Universal pliers, adjustable pliers, cutting nippers, extra-long nose pliers, lock-grip pliers	519/150AX
11	Cutting tools, hammer, chisels	519/200I
22	Socket bits for hex and TORX® socket screws	519/234C
8	T-handle wrenches with jointed hexagonal socket/ 7-8-10-11-13-14-17-19 mm	519/276
8	T-handle keys/2-2,5-3-4-5-6-8-10 mm	519/280T
25	Combination wrenches (6÷24), angled hexagon keys (1,5÷10)	519/285A1
4	Combination wrenches/27-29-30-32	519/285B2
10	Screwdrivers for slot-head and PHILLIPS® screws	519/324H
22	Hexagonal sockets, ratchet 237 A 1/2" and accessories (1/2")	519/613CEA

kg	code	1
19,5	U04950012	1



519/127N 519/150AX 519/285A1



519/613CEA 519/324H 519/324TX



519/276



## 495 A1

### Assortment for car repair (83 pcs.) - 3 drawers

- Supplied with plastic trays



pcs	description	item/size
4	Pliers for circlips (19÷60)	519/127N
5	Universal pliers, adjustable pliers, cutting nippers, extra-long nose pliers, lock-grip pliers	519/150AX
8	T-handle wrenches with jointed hexagonal socket/7-8-10-11-13-14-17-19 mm	519/276
25	Combination wrenches (6÷24), angled hexagon keys (1,5÷10)	519/285A1
10	Screwdrivers for slot-head and PHILLIPS® screws	519/324H
9	TORX® screwdrivers (T6÷T30)	519/324TX
22	Hexagonal sockets, ratchet 237 A 1/2" and accessories (1/2")	519/613CEA

kg	code	1
13	U04950011	1



**CREATE YOUR IDEAL ASSORTMENT!**  
Go to [kitplanner-gb.usag.it](http://kitplanner-gb.usag.it)  
or frame the QR code





519/285A1 519/294 519/613CEA



519/150AX 519/324H 519/127N



519/200I



495 I1

**Assortment for industrial maintenance (86 pcs.) - 3 drawers**

- Supplied with plastic trays

pcs	description	item/size
4	Pliers for circlips (19÷60)	519/127N
5	Universal pliers, adjustable pliers, cutting nippers, extra-long nose pliers, lock-grip pliers	519/150AX
11	Cutting tools, hammer, chisels	519/200I
25	Combination wrenches (6÷24), angled hexagon keys (1,5÷10)	519/285A1
9	Adjustable wrench, shears for sheet steel, pin punches, tape rule	519/294
10	Screwdrivers for slot-head and PHILLIPS® screws	519/324H
22	Hexagonal sockets, ratchet 237 A 1/2" and accessories (1/2")	519/613CEA

kg	code	1
12	U04950021	1



519/285A1 519/285B2 519/294



519/150AX 519/324H 519/990A1



519/127N 519/613CEA 519/283



519/200I



495 I2

**Assortment for industrial maintenance (103 pcs.) - 4 drawers**

- Supplied with plastic trays

pcs	description	item/size
1	Oilers	420/300
4	Pliers for circlips (19÷60)	519/127N
5	Universal pliers, adjustable pliers, cutting nippers, extra-long nose pliers, lock-grip pliers	519/150AX
11	Cutting tools, hammer, chisels	519/200I
8	Offset ring wrenches (6x7÷18x19)	519/283
25	Combination wrenches (6÷24), angled hexagon keys (1,5÷10)	519/285A1
4	Combination wrenches(27-29-30-32)	519/285B2
9	Adjustable wrench, shears for sheet steel, pin punches, tape rule	519/294
10	Screwdrivers for slot-head and PHILLIPS® screws	519/324H
22	Hexagonal sockets, ratchet 237 A 1/2" and accessories (1/2")	519/613CEA
4	Assortment with files (half-round, flat, round, triangular) PA/PB/PC/PE	519/990A1

kg	code	1
15	U04950022	1



519/613AEA 519/613CEA 519 SK692V 692 J32



519/324H 519/285A1 519/150AX



276 CE



495 PA

**Assortment for car repair (142 pcs.)**

- Supplied with plastic trays

6	T-handle wrenches with jointed hexagonal socket/ 7-8-10-12-13-17	276 CE
5	Universal pliers, adjustable pliers, cutting nippers, extra-long nose pliers, lock-grip pliers	519/150AX
25	Combination wrenches (6÷24), angled hexagon keys (1,5÷10)	519/285A1
10	Screwdrivers for slot-head and PHILLIPS® screws	519/324H
42	Hex sockets (4÷14), bits, ratchet and accessories ¼	519/613AEA
22	Hexagonal sockets, ratchet 237 A 1/2" and accessories (1/2")	519/613CEA
32	Assortment with bits and reversible ratchet - 1/4" (32 pcs.)	692 J32
1	Plastic tray (4 compartments)	519 SK692V

code	1
U04950629	1



519/613AEA 519/613CEA 519 SK692V



519/285A1 519/150AX 519 SK692V



519/324H 519/324TX 519 SK692V 692 J32



519 SK692V 519/990A1 519/382F



495 PM

**Assortment for MAINTENANCE (157 pcs.) - 4 drawers**

- Supplied with plastic trays

pcs	description	item/size
5	Universal pliers, adjustable pliers, cutting nippers, extra-long nose pliers, lock-grip pliers	519/150AX
25	Combination wrenches (6÷24), angled hexagon keys (1,5÷10)	519/285A1
10	Screwdrivers for slot-head and PHILLIPS® screws	519/324H
9	TORX® screwdrivers (T6÷T30)	519/324TX
8	Chisel, pin punch (2x100-3x130-4x145-5x165), centre punch, mallet, hammers with graphite handle	519/382F
42	Hex sockets (4÷14), bits, ratchet and accessories ¼	519/613AEA
22	Hexagonal sockets, ratchet 237 A 1/2" and accessories (1/2")	519/613CEA
4	Assortment with files (half-round, flat, round, triangular) PA/PB/PC/PE	519/990A1
32	Assortment with bits and reversible ratchet - 1/4" (32 pcs.)	692 J32

4	Plastic tray (4 compartments)	519 SK692V
---	-------------------------------	------------

code	1
U04950630	1

# RANGE OF BI-COLOUR FOAM MODULES



519 M 098HYB8 519 M 098HYB11 076 G / 519 M SK6V



## 495 098HYB

### Assortment for safety and maintenance of battery cells (20 pcs.) - 1 drawer

- Supplied with bi-colour foam modules

pcs	description	item/size
1	Voltage tester	076 G
8	1000 V bihexagonal sockets (8-10-12), 1000 V ratchet (098 A 3/8"), 1000 V extension 3/8", 1000 V screwdriver for slot-head screws (1x5,5x125), 1000 V screwdriver for PHILLIPS® screws (2x125), 1000 V half-round extra-large nose pliers	519 M 098HYB8
11	1000 V bihexagonal sockets (11-13-14), 1000 V bihexagonal ring wrenches (8-10-12-13-14), 1000 V screwdrivers for slot-head screws (0,5x3x75-0,8x4x100-1,2x6,5x150)	519 M 098HYB11
1	Foam module for small parts (empty)	519 M SK6V

code U04958010 1



519 M 098HYB8 519 M 098HYB11 076 G / 519 M SK6V



519 M 613AEA 519 M 613CEA 519 M 285A1



519 M 324H 519 M 324STX 519 M 150AX

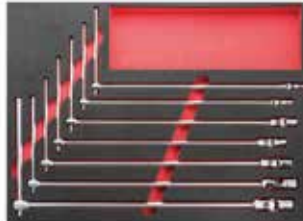

519 M 276



## 495 HYB133



### Assortment for hybrid and electric cars and standard maintenance (133 pcs.) - 4 drawers

- Supplied with bi-colour foam modules

pcs	description	item/size
1	Voltage tester	076 G
8	1000 V bihexagonal sockets (8-10-12), 1000 V ratchet (098 A 3/8"), 1000 V extension 3/8", 1000 V screwdriver for slot-head screws (1x5,5x125), 1000 V screwdriver for PHILLIPS® screws (2x125), 1000 V half-round extra-large nose pliers	519 M 098HYB8
11	1000 V bihexagonal sockets (11-13-14), 1000 V bihexagonal ring wrenches (8-10-12-13-14), 1000 V screwdrivers for slot-head screws (0,5x3x75-0,8x4x100-1,2x6,5x150)	519 M 098HYB11
5	Universal pliers, adjustable pliers, cutting nippers, extra-long nose pliers, lock-grip pliers	519 M 150AX
7	T-handle wrenches with jointed hexagonal socket (7-8-10-11-13-17-19)	519 M 276
17	Combination wrenches (6÷24)	519 M 285A1
8	Screwdrivers for slot-head and PHILLIPS® screws	519 M 324H
7	Screwdrivers for TORX® Tamper Resistant screws/ T10-T15-T20-T25-T27-T30-T40	519 M 324STX
46	Hexagonal sockets, ratchet (237 A 1/4"), accessories 1/4" and bits	519 M 613AEA
23	Hexagonal sockets, ratchet (237 A 1/2") and accessories 1/4"	519 M 613CEA
1	Foam module for small parts (empty)	519 M SK6V

code U04958009 1



519 M 285A1 519 M 324H 519 M 324STX



519 M 612AEA 519 M 612CLA



519 M 276C



## 495 MAA

### Assortment for car repair (155 pcs.) - 3 drawers

- Supplied with bi-colour foam modules

pcs	description	item/size
42	T-handle wrenches with jointed hexagonal socket (8-10-13-17), pliers for circlips (19÷60), universal plier, nose plier	519 M 276C
17	Combination wrenches (6÷24)	519 M 285A1
7	Screwdrivers for slot-head and PHILLIPS® screws	519 M 324H
8	Screwdrivers for TORX® Tamper Resistant screws/ T10-T15-T20-T25-T27-T30-T40	519 M 324STX
35	Hex sockets, ratchet and accessories 1/2"	519 M 612CLA
46	Hexagonal sockets, ratchet (237 A 1/4"), accessories 1/4" and bits	519 M 613AEA



code U04950627 1



519 M 127N 519 M 150AX 519 M 324H



519 M 613AEA 519 M 613CEA 519 M 285A1

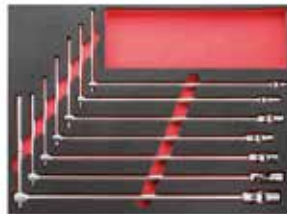

519 M 276



## 495 MMA

### Assortment for car repair (110 pcs.) - 3 drawers

- Supplied with bi-colour foam modules

pcs	description	item/size
4	Pliers for circlips (19÷60)	519 M 127N
5	Universal pliers, adjustable pliers, cutting nippers, extra-long nose pliers, lock-grip pliers	519 M 150AX
7	T-handle wrenches with jointed hexagonal socket (7-8-10-11-13-17-19)	519 M 276
17	Combination wrenches (6÷24)	519 M 285A1
8	Screwdrivers for slot-head and PHILLIPS® screws	519 M 324H
46	Hexagonal sockets, ratchet (237 A 1/4"), accessories 1/4" and bits	519 M 613AEA
23	Hexagonal sockets, ratchet (237 A 1/2") and accessories 1/4"	519 M 613CEA



code U04958003 1

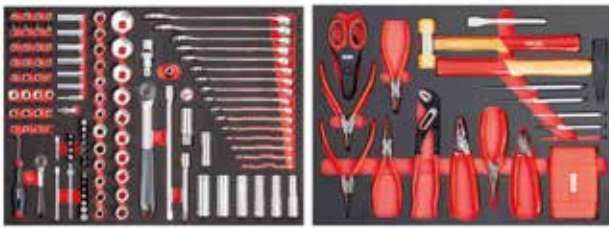

519 M 601

519 M 150



519 M 322H 519 M 322STX 519 M 280N1



## 495 MME

### Assortment for MAINTENANCE (296 pcs.) - 3 drawers

- Supplied with bi-colour foam modules

pcs	description	item/size
49	Adjustable plier, chisel, pin punch, hammer, scissor, assortment with bits, plier for circlips, universal plier, nose plier, cutting nipper, mallet	519 M 150
117	Set of keys for TORX® screws and assortment of bits with special shapes	519 M 280N1
8	Screwdrivers for slot-head and PHILLIPS® screws	519 M 322H
6	Screwdrivers for TORX® Tamper Resistant screws/ T10-T15-T20-T25-T30-T40	519 M 322STX
116	Combination wrenches, sockets, ratchet and accessories	519 M 601

code

U04950633 1



519 M 127N 519 M 150AX 519 M 382F



519 M 613AEA 519 M 613CEA 519 M 285A1

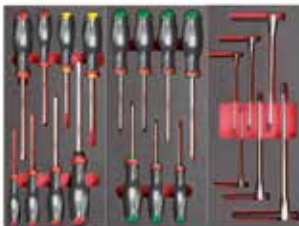

519 M 324H 519 M 324STX 519 M 280TK



## 495 MMI

### Assortment for industrial maintenance (123 pcs.) - 3 drawers

- Supplied with bi-colour foam modules

pcs	description	item/size
4	Pliers for circlips (19÷60)	519 M 127N
5	Universal pliers, adjustable pliers, cutting nippers, extra-long nose pliers, lock-grip pliers	519 M 150AX
6	T-handle hexagon keys with sliding bar (2,5-3-4-5-6-8)	519 M 280TK
17	Combination wrenches (6÷24)	519 M 285A1
8	Screwdrivers for slot-head and PHILLIPS® screws	519 M 324H
7	Screwdrivers for TORX® Tamper Resistant screws/ T10-T15-T20-T25-T27-T30-T40	519 M 324STX
7	Hammers, chisels and pin punches	519 M 382F
46	Hexagonal sockets, ratchet (237 A 1/4"), accessories 1/4" and bits	519 M 613AEA
23	Hexagonal sockets, ratchet (237 A 1/2") and accessories 1/4"	519 M 613CEA

code

U04958004 1



519 M 613AEA 519 M 613CEA 519 M 285A1



519 M 127C 519 M 150AX 519 M SK6



519 M 324H 519 M 324STX 519 M SK6V / 692 J32



519 M 990A5B 519 M 382F 519 M SK6



## 495 MB

### Assortment for MAINTENANCE (156 pcs.) - 4 drawers

- Supplied with bi-colour foam modules

pcs	description	item/size
6	Plier for circlips (12÷25, 19÷60)	519 M 127C
5	Universal pliers, adjustable pliers, cutting nippers, extra-long nose pliers, lock-grip pliers	519 M 150AX
17	Combination wrenches (6÷24)	519 M 285A1
7	Screwdrivers for slot-head and PHILLIPS® screws	519 M 324H
8	Screwdrivers for TORX® Tamper Resistant screws/ T10-T15-T20-T25-T27-T30-T40	519 M 324STX
7	Hammers, chisels and pin punches	519 M 382F
46	Hexagonal sockets, ratchet (237 A 1/4"), accessories 1/4" and bits	519 M 613AEA
23	Hexagonal sockets, ratchet (237 A 1/2") and accessories 1/4"	519 M 613CEA
5	Files bastard cut	519 M 990A5B
32	Assortment with bits and reversible ratchet - 1/4" (32 pcs.)	692 J32
3	Foam module for small parts (empty)	519 M SK6V

code

U04950628 1



519 M 612CLA 519 M 613CEA 519 M 613AEA



519 M 285KA 519 M 285A1 519 M 285A2 519 M 294B



519 M 324H 519 M 324STX 519 M 280HG 519 M 280N1



519 M 127N 519 M 150AX 519 M 382F 519 M 990A5MD



## 495 MC

### Assortment for MAINTENANCE (300 pcs.) - 4 drawers

- Supplied with bi-colour foam modules

pcs	description	item/size
4	Pliers for circlips (19÷60)	519 M 127N
5	Universal pliers, adjustable pliers, cutting nippers, extra-long nose pliers, lock-grip pliers	519 M 150AX
7	Angled hexagon keys with bimaterial handgrip (3-4-5-6-7-8-10)	519 M 280HG
117	Set of keys for TORX® screws and assortment of bits with special shapes	519 M 280N1
17	Combination wrenches (6÷24)	519 M 285A1
5	Combination wrenches (27÷34)	519 M 285A2
12	Reversible ratchet combination wrenches 8-9-10-11-12-13-14-15-16-17-18-19 mm	519 M 285KA
4	Short adjustable wrench, scissor, lock-grip plier	519 M 294B
7	Hammers, chisels and pin punches	519 M 382F
8	Screwdrivers for slot-head and PHILLIPS® screws	519 M 324H
7	Screwdrivers for TORX® Tamper Resistant screws/ T10-T15-T20-T25-T27-T30-T40	519 M 324STX
35	Bi-hexagonal sockets, ratchet (237 A 1/2") and accessories 1/2"	519 M 612CLA
46	Hexagonal sockets, ratchet (237 A 1/4"), accessories 1/4" and bits	519 M 613AEA
20	Hexagonal sockets, ratchet (237 A 3/8") and accessories 3/8"	519 M 613BEA
5	Second-cut files	519 M 990A5MD

code

U04950632 1





519 M 613AEA 519 M 613CEA 519 M SK6V



519 M 324H 519 M 324STX 519 M SK6V



519 M 285A1 519 M 150AX 519 M SK6V



519 M 990A5MD 692 J32



519 M 613AEA 519 M 613CEA 519 M SK6V



519 M 324H 519 M 324STX 519 M SK6V



519 M 285A1 519 M 150AX 519 M SK6V



519 M 236K



270 C



## 495 MIU

### Assortment for MAINTENANCE (143 pcs.) - 3 drawers

- Supplied with bi-colour foam modules



pcs	description	item/size
5	Universal pliers, adjustable pliers, cutting nippers, extra-long nose pliers, lock-grip pliers	519 M 150AX
17	Combination wrenches (6÷24)	519 M 285A1
8	Screwdrivers for slot-head and PHILLIPS® screws	519 M 324H
7	Screwdrivers for TORX® Tamper Resistant screws/ T10-T15-T20-T25-T27-T30-T40	519 M 324STX
46	Hexagonal sockets, ratchet (237 A 1/4"), accessories 1/4" and bits	519 M 613AEA
23	Hexagonal sockets, ratchet (237 A 1/2") and accessories 1/4"	519 M 613CEA
5	Second-cut files	519 M 990A5MD
32	Assortment with bits and reversible ratchet - 1/4" (32 pcs.)	692 J32
3	Foam module for small parts (empty)	519 M SK6V

code U04950626 1



## 495 MSA

### Assortment for car repair (151 pcs.) - 3 drawers

- Supplied with bi-colour foam modules



pcs	description	item/size
3	Impact sockets for tyre rims with teflon protection (17-19-21)	270 C
5	Universal pliers, adjustable pliers, cutting nippers, extra-long nose pliers, lock-grip pliers	519 M 150AX
13	Extension wrench with impact sockets 10-11-12-13-14-15-16-17-18-19-22-24	519 M 236K
17	Combination wrenches (6÷24)	519 M 285A1
8	Screwdrivers for slot-head and PHILLIPS® screws	519 M 324H
7	Screwdrivers for TORX® Tamper Resistant screws/ T10-T15-T20-T25-T27-T30-T40	519 M 324STX
46	Hexagonal sockets, ratchet (237 A 1/4"), accessories 1/4" and bits	519 M 613AEA
23	Hexagonal sockets, ratchet (237 A 1/2") and accessories 1/4"	519 M 613CEA
3	Foam module for small parts (empty)	519 M SK6V

code U04950625 1

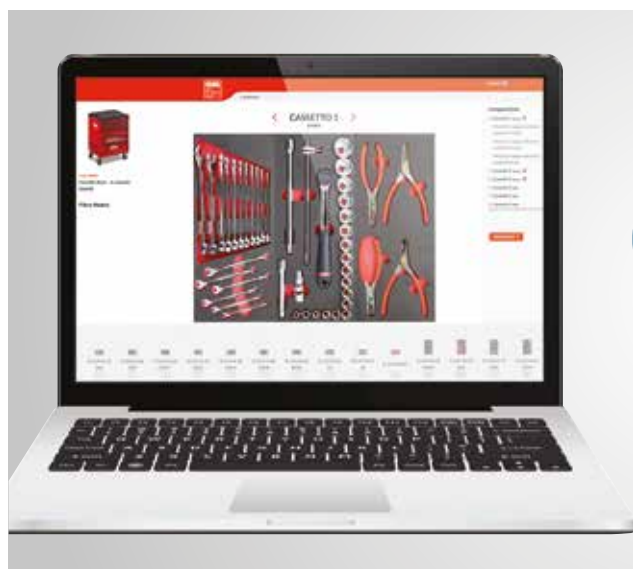

**CREATE YOUR IDEAL ASSORTMENT!**  
Go to [kitplanner-gb.usag.it](http://kitplanner-gb.usag.it)  
or frame the QR code







## 496 A1

### Basic assortment (47 pcs.)

- Supplied without plastic trays



pcs	description	item/size
1	Combination pliers	150 AX/180
1	Lay-on slip-joint adjustable pliers	178 N/250
1	Diagonal cutting nippers	185 AX/160
1	Hacksaw	200 S
1	Scissors for electricians, steel blades	207 C
8	Hexagonal sockets / 10-11-12-13-14-17-19-22	235 1/2 EN
2	Extensions/125-250	236 1/2
1	Reversible ratchet with sealed mechanism (certified IP51)	237 A 1/2
1	T-handle with sliding square drive	240 1/2 N
1	Universal joint	241 1/2
9	Set of 9 angled hexagon keys /1,5-2-2,5-3-4-5-6-8-10	280 S9
12	Combination wrenches /6-7-8-9-10-11-12-13-14-17-19-22	285
4	Screwdrivers for slot-head screws/ 0,5x3x75-0,8x4x100-1x5,5x125-1,2x6,5x150	324
2	Screwdrivers for PHILLIPS® screws/ 1x75-2x100	324 PH
1	Mallets	376/35
1	Hammers for mechanics	382/500

 Kg	code	
5	U04960005	1





## 496 A2

### Basic assortment (74 pcs.)

- Supplied without plastic trays



pcs	description	item/size
1	Pliers with straight nose for internal circlips	127 N/19÷60
1	Pliers with straight nose for external circlips	128 N/19÷60
1	Lock-grip pliers with concave jaws	134/250
1	Combination pliers	150 AX/180
1	Lay-on slip-joint adjustable pliers	178 N/250
1	Diagonal cutting nippers	185 AX/160
1	Hacksaw	200 S
1	Shears for sheet steel	204/250
1	Scissors for electricians, steel blades	207 C
9	Set of 9 angled hexagon keys/ 1,5-2-2,5-3-4-5-6-8-10	280 S9
17	Set of 17 combination wrenches /6-7-8-9-10-11-12-13-14-15-16-17-18-19-20-21-22	285 SE17
1	Reversible screwdriver for slot-head and PHILLIPS® screws	322 R/1x6x75
4	Screwdrivers for slot-head screws/ 0,5x3x75-0,8x4x100-1x5,5x125-1,2x6,5x150	324
2	Screwdrivers for PHILLIPS® screws / 1x75 - 2x100	324 PH
6	Assortment in plastic pouch (6 pcs.) / 362/125-150; 364/125; 366/3x125-4x150; 368/4x125	372 SE6
1	Mallets	376/35
1	Hammers for mechanics	382/300
1	Oilers	420/500
23	Assortment with hexagonal sockets in ABS case (23 pcs.)	606 1/2 EA

 Kg	code	
14	U04960007	1



## 496 AP2

### Basic assortment (59 pcs.)

- Supplied without plastic trays



pcs	description	item/size
1	Pliers with straight nose for internal circlips	127 N/19÷60
1	Pliers with straight nose for external circlips	128 N/19÷60
1	Lock-grip pliers with concave jaws	134/250
1	Lay-on slip-joint adjustable pliers	178 N/250
1	Hacksaw	200 S
1	Shears for sheet steel	204/250
1	Scissors for electricians, steel blades	207 C
8	Set of 8 angled hexagon keys, inch sizes / 1/16-5/64-3/32-1/8-5/32-3/16-7/32-1/4	280 P/SE8
13	Set of 13 combination wrenches, inch sizes / 1/4-5/16-3/8-7/16-1/2-9/16-5/8-11/16-3/4-13/16-7/8-15/16-1	285 P/SE13
1	Reversible screwdriver for slot-head and PHILLIPS® screws	322 R/1x6x75
4	Screwdrivers for slot-head screws/ 0,5x3x75-0,8x4x100-1x5,5x125-1,2x6,5x150	324
2	Screwdrivers for PHILLIPS® screws / 1x75 - 2x100	324 PH
6	Assortment in plastic pouch (6 pcs.) / 362/125-150; 364/125; 366/3x125-4x150; 368/4x125	372 SE6
1	Mallets	376/35
1	Hammers for mechanics	382/300
1	Oilers	420/500
15	Assortment with bihexagonal sockets in ABS case, in inches (15 pcs.)	606 1/2 APOL

 Kg	code	
13	U04960008	1



### 496 B1 mm



#### Assortment for car repair (87 pcs.)

- Supplied without plastic trays



pcs	description	item/size
1	Pliers with straight nose for internal circlips	127 N/19=60
1	Pliers with straight nose for external circlips	128 N/19=60
1	Half-round extra-long nose pliers with straight jaws	133 AX/160
1	Lock-grip pliers with concave jaws	134/250
1	Combination pliers	150 AX/180
1	Lay-on slip-joint adjustable pliers	178 N/250
1	Heavy-duty diagonal cutting nippers	188 AX/160
1	Scissors for electricians, steel blades	207 C
8	T-handle wrenches with jointed hexagonal socket/7-8-10-11-13-14-17-19	276 CE
2	T-handle spark plug wrenches with jointed socket	278 N/16-20,8
9	Set of 9 angled hexagon keys/1,5-2-2,5-3-4-5-6-8-10	280 S9
17	Set of 17 combination wrenches /6-7-8-9-10-11-12-13-14-15-16-17-18-19-20-21-22	285 SE17
4	Screwdrivers for slot-head screws/0,5x3x75-0,8x4x100-1x5,5x125-1,2x6,5x150	324
1	Screwdrivers for slot-head screws /1,6x8x175	324 E
1	Screwdrivers for PHILLIPS® screws/3x150	324 EPH
1	Screwdrivers for slot-head screws /0,8x4x35	324 N
1	Screwdrivers for PHILLIPS® screws	324 NPH/2x35

pcs	description	item/size
2	Screwdrivers for PHILLIPS® screws /1x75-2x100	324 PH
6	Assortment in plastic pouch (6 pcs.) /362/125-150; 364/125; 366/3x125-4x150; 368/4x125	372 SE6
1	Mallets	376/35
1	Hammers for mechanics	382/300
1	Oilers	420/500
23	Assortment with hexagonal sockets in ABS case (23 pcs.)	606 1/2 EA
1	Thickness gauges	966/19 L

kg	code	img
15	U04960015	



### 496 B2 mm



#### Assortment for car repair (146 pcs.)

- Supplied without plastic trays



pcs	description	item/size
1	Pliers with straight nose for internal circlips	127 N/19=60
1	Pliers with straight nose for external circlips	128 N/19=60
1	Half-round extra-long nose pliers with straight jaws	133 AX/160
1	Lock-grip pliers with concave jaws	134/250
1	Combination pliers	150 AX/180
1	Lay-on slip-joint adjustable pliers	178 N/250
1	Heavy-duty diagonal cutting nippers	188 AX/160
1	Hacksaw	200 S
1	Scissors for electricians, steel blades	207 C
13	Set of 13 double ended open jaw wrenches /6x7-8x9-10x11-12x13-14x15-16x17-18x19-20x22-21x23-24x26-25x28-27x29-30x32	252 N/SR13
5	Set of 5 bihexagonal ring wrenches /10x12-11x13-15x17-16x18-19x22	258 N/SE5
16	Oil draining kit (16 pcs.)	263/S16
1	Assortment with hexagonal impact sockets for tyre rims with teflon protection in modular box (3 pcs.)/17-19-21	270 C/C3
1	Cross-type wheel nut wrenches (cars and light industrial vehicles)/17x19x22x1/2"	272
8	T-handle wrenches with jointed hexagonal socket/7-8-10-11-13-14-17-19	276 CE
3	Spark plug sockets/16-18-20,8	279 N 1/2
9	Set of 9 angled hexagon keys/1,5-2-2,5-3-4-5-6-8-10	280 S9
4	Combination wrenches/24-27-30-32	285
17	Set of 17 combination wrenches /6-7-8-9-10-11-12-13-14-15-16-17-18-19-20-21-22	285 SE17
4	Screwdrivers for slot-head screws /0,5x3x75-0,8x4x100-1x5,5x125-1,2x6,5x150	324
1	Screwdrivers for slot-head screws /1,6x8x175	324 E
1	Screwdrivers for PHILLIPS® screws/3x150	324 EPH
1	Screwdrivers for slot-head screws/0,8x4x35	324 N

pcs	description	item/size
1	Screwdrivers for PHILLIPS® screws	324 NPH/2x35
2	Screwdrivers for PHILLIPS® screws /1x75-2x100	324 PH
7	Screwdrivers for TORX® screws/T10x75-T15x75-T20x100-T25x100-T27x100-T30x125-T40x150	324 TX
1	Ribbed chisels	351/200
6	Assortment in plastic pouch (6 pcs.) /362/125-150; 364/125; 366/3x125-4x150; 368/4x125	372 SE6
1	Mallets	376/35
2	Hammers for mechanics	382/300-500
1	Oilers	420/500
1	Flexible retrievers with magnetic head	442 N/1
23	Assortment with hexagonal sockets in ABS case (23 pcs.)	606 1/2 EA
1	Thickness gauges with long blades	966 L/160
5	Set of five files (990 M PA=M PE)	990 M2/SE5

kg	code	img
27	U04960017	



### 496 B3

#### Assortment for car repair (203 pcs.)

- Supplied without plastic trays



pcs	description	item/size
1	Pliers with straight nose for internal circlips	127 N/19÷60
1	Pliers with straight nose for external circlips	128 N/19÷60
1	Half-round extra-long nose pliers with straight jaws	133 AX/160
1	Lock-grip pliers with concave jaws	134/250
1	Combination pliers	150 AX/180
1	Lay-on slip-joint adjustable pliers	178 N/250
1	Heavy-duty diagonal cutting nippers	188 AX/160
1	Hacksaw	200 S
1	Scissors for electricians, steel blades	207 C
13	Set of 13 double ended open jaw wrenches /6x7-8x9-10x11-12x13-14x15-16x17-18x19-20x22-21x23-24x26-25x28-27x29-30x32	252 N/SR13
5	Set of 5 bihexagonal ring wrenches / 10x12-11x13-14x17-16x18-19x22	258 N/SE5
16	Oil draining kit (16 pcs.)	263/S16
5	Assortment with hexagonal impact sockets for tyre rims with teflon protection in ABS case (5 pcs.)/15-17-19-21-22	270 C/C5
1	Cross-type wheel nut wrenches (cars and light industrial vehicles)/17x19x22x1/2"	272
8	T-handle wrenches with jointed hexagonal socket/7-8-10-11-13-14-17-19	276 CE
3	Spark plug sockets/16-18-20,8	279 N 1/2
9	Set of 9 angled hexagon keys/ 1,5-2-2,5-3-4-5-6-8-10	280 S9
13	Set of 13 offset bihexagonal ring wrenches /6x7-8x9-10x11-12x13-14x15-16x17-18x19-20x22-21x23-24x26-25x28-27x29-30x32	283 SE13
4	Combination wrenches/24-27-30-32	285
17	Set of 17 combination wrenches /6-7-8-9-10-11-12-13-14-15-16-17-18-19-20-21-22	285 SE17
1	Adjustable wrenches with quick adjustment	294 AD/250
4	Screwdrivers for slot-head screws/ 0,5x3x75-0,8x4x100-1x5,5x125-1,2x6,5x150	324
1	Screwdrivers for slot-head screws / 1,6x8x175	324 E
1	Screwdrivers for PHILLIPS® screws/3x150	324 EPH
1	Screwdrivers for slot-head screws / 0,8x4x35	324 N
1	Screwdrivers for PHILLIPS® screws	324 NPH/2x35
2	Screwdrivers for PHILLIPS® screws/ 1x75-2x100	324 PH
7	Screwdrivers for TORX® screws / T10x75-T15x75-T20x100-T25x100-T27x100-T30x125-T40x150	324 TX
1	Ribbed chisels	351/200
6	Assortment in plastic pouch (6 pcs.) / 362/125-150; 364/125; 366/3x125-4x150; 368/4x125	372 SE6
1	Mallets	376/35
2	Hammers for mechanics	382/300-500
1	Oilers	420/500
1	Flexible retrievers with magnetic head	442 N/1
1	Fast oil-filter wrench (cars)	443 N
1	Articulated chain wrench for oil filters	445
23	Assortment with hexagonal sockets in ABS case (23 pcs.)	606 1/2 EA
38	Assortment with hexagonal sockets and bits in bimaterial box (38 pcs.)	609 1/4 EB
1	Thickness gauges with long blades	966 L/160
5	Set of five files (990 M PA÷M PE)	990 M2/SE5
1	Brush for spark plugs	993 C

Kg	code	
35	U04960019	1

### 496 BP3

#### Assortment for car repair (150 pcs.)

- Supplied without plastic trays



pcs	description	item/size
1	Pliers with straight nose for internal circlips	127 N/19÷60
1	Pliers with straight nose for external circlips	128 N/19÷60
1	Half-round extra-long nose pliers with straight jaws	133 AX/160
1	Lock-grip pliers with concave jaws	134/250
1	Combination pliers	150 AX/180
1	Lay-on slip-joint adjustable pliers	178 N/250
1	Heavy-duty diagonal cutting nippers	188 AX/160
1	Hacksaw	200 S
1	Scissors for electricians, steel blades	207 C
12	Double ended open jaw wrenches, inch sizes/1/4x5/16÷1 3/16x1 5/16"	252 NP
5	Set of 5 bihexagonal ring wrenches / 10x12-11x13-14x17-16x18-19x22	258 N/SE5
16	Oil draining kit (16 pcs.)	263/S16
1	Cross-type wheel nut wrenches (cars and light industrial vehicles)/17x19x22x1/2"	272
8	T-handle wrenches with jointed hexagonal socket/7-8-10-11-13-14-17-19	276 CE
3	Spark plug sockets/16-18-20,8	279 N 1/2
8	Set of 8 angled hexagon keys, inch sizes/1/16÷1/4"	280 P/SE8
17	Combination wrenches, inch sizes / 1/4÷1 5/16"	285 P
1	Adjustable wrenches with quick adjustment	294 AD/250
4	Screwdrivers for slot-head screws/ 0,5x3x75-0,8x4x100-1x5,5x125-1,2x6,5x150	324
1	Screwdrivers for slot-head screws/ 1,6x8x175	324 E
1	Screwdrivers for PHILLIPS® screws/3x150	324 EPH
1	Screwdrivers for slot-head screws/ 0,8x4x35	324 N
1	Screwdrivers for PHILLIPS® screws	324 NPH/2x35
2	Screwdrivers for PHILLIPS® screws / 1x75-2x100	324 PH
7	Screwdrivers for TORX® screws/ T10x75-T15x75-T20x100-T25x100-T27x100-T30x125-T40x150	324 TX
1	Ribbed chisels	351/200
6	Assortment in plastic pouch (6 pcs.) / 362/125-150; 364/125; 366/3x125-4x150; 368/4x125	372 SE6
1	Mallets	376/35
2	Hammers for mechanics	382/300-500
1	Oilers	420/500
1	Flexible retrievers with magnetic head	442 N/1
1	Fast oil-filter wrench (cars)	443 N
15	Assortment with bihexagonal sockets in ABS 606 1/2 APOL case, in inches (15 pcs.)	606 1/2 APOL
18	Assortment with hexagonal sockets in ABS case, in inches (18 pcs.)	606 1/4 APOL
1	Thickness gauges with long blades	966 L/160
5	Set of five files (990 M PA÷M PE)	990 M2/SE5
1	Brush for spark plugs	993 C

Kg	code	
32	U04960020	1



## 496 B4



### Assortment for car repair (240 pcs.)

- Supplied without plastic trays



pcs	description	item/size
1	Pliers with straight nose for internal circlips	127 N/19÷60
1	Pliers with nose bent at 90° for internal circlips	127 PN/19÷60
1	Pliers with straight nose for external circlips	128 N/19÷60
1	Pliers with nose bent at 90° for external circlips	128 PN/19÷60
1	Half-round extra-long nose pliers with straight jaws	133 AX/160
1	Half-round extra-long nose pliers with jaws at 45°	133 AXP/160
1	Lock-grip pliers with concave jaws	134/250
1	Combination pliers	150 AX/180
1	Lay-on slip-joint adjustable pliers	178 N/250
1	Heavy-duty diagonal cutting nippers	188 AX/160
1	Hacksaw	200 S
1	Shears for sheet steel	204/250
1	Scissors for electricians, steel blades	207 C
1	Utility knife with snap-off blades	220 B1
9	Set of 9 socket bits for TORX® screws / T20-T25-T27-T30-T40-T45-T50-T55-T60	233 1/2 NTX/S9
7	Set of 7 TORX® sockets / E10-E12-E14-E16-E18-E20-E24	235 1/2 NTX/S7
12	Set of 12 small double ended open jaw wrenches/ 3,2-4-4,5-5-5,5-6-7-8-10-12-13-14	250 N/SE12
13	Set of 13 double ended open jaw wrenches /6x7-8x9-10x11-12x13-14x15-16x17-18x19-20x22-21x23-24x26-25x28-27x29-30x32	252 N/SR13
5	Set of 5 bihexagonal ring wrenches / 10x12-11x13-14x17-16x18-19x22	258 N/SE5
16	Oil draining kit (16 pcs.)	263/S16
5	Assortment with hexagonal impact sockets for tyre rims with teflon protection in ABS case (5 pcs.)/15-17-19-21-22	270 C/C5
1	Cross-type wheel nut wrenches (cars and light industrial vehicles)/17x19x22x1/2"	272
1	T-handle key with jointed square drive	273 1/2 Q
8	T-handle wrenches with jointed hexagonal socket/7-8-10-11-13-14-17-19	276 CE
3	Spark plug sockets/16-18-20,8	279 N 1/2
9	Set of 9 angled hexagon keys / 1,5-2-2,5-3-4-5-6-8-10	280 S9
13	Set of 13 offset bihexagonal ring wrenches /6x7-8x9-10x11-12x13-14x15-16x17-18x19-20x22-21x23-24x26-25x28-27x29-30x32	283 SE13

pcs	description	item/size
4	Combination wrenches/24-27-30-32	285
17	Set of 17 combination wrenches /6-7-8-9-10-11-12-13-14-15-16-17-18-19-20-21-22	285 SE17
1	Adjustable wrenches with quick adjustment	294 AD/250
4	Screwdrivers for slot-head screws/ 0,5x3x75-0,8x4x100-1x5,5x125-1,2x6,5x150	324
1	Screwdrivers for slot-head screws / 1,6x8x175	324 E
1	Screwdrivers for PHILLIPS® screws/3x150	324 EPH
1	Screwdrivers for slot-head screws/ 0,8x4x35	324 N
1	Screwdrivers for PHILLIPS® screws	324 NPH/2x35
2	Screwdrivers for PHILLIPS® screws / 1x75-2x100	324 PH
7	Screwdrivers for TORX® screws / T10x75-T15x75-T20x100-T25x100-T27x100-T30x125-T40x150	324 TX
1	Ribbed chisels	351/200
6	Assortment in plastic pouch (6 pcs.) /362/125-150; 364/125; 366/3x125-4x150; 368/4x125	372 SE6
1	Mallets	376/35
2	Hammers for mechanics	382/300-500
1	Oilers	420/500
1	Rolling head bar	429/400
1	Flexible retrievers with magnetic head	442 N/1
1	Fast oil-filter wrench (cars)	443 N
1	Ball-joint extractors	449/22
23	Assortment with hexagonal sockets in ABS case (23 pcs.)	606 1/2 EA
38	Assortment with hexagonal sockets and bits in bimaterial box (38 pcs.)	609 1/4 EB
1	Crimping pliers for non-insulated open and closed terminals	746
1	Thickness gauges	966/19 L
1	Professional tape rules with shockproof covering	981 A/3
5	Set of five files (990 M PA-M PE)	990 M2/SE5
1	Brush for spark plugs	993 C

kg	code	
42	U04960025	1



## 496 B5



### Assortment for car repair (118 pcs.)

- Supplied with hooks and supports for cabinets 502  
- Supplied without plastic trays



pcs	description	item/size
1	Pliers with straight nose for internal circlips	127 N/19÷60
1	Pliers with nose bent at 90° for internal circlips	127 PN/19÷60
1	Pliers with straight nose for external circlips	128 N/19÷60
1	Pliers with nose bent at 90° for external circlips	128 PN/19÷60
1	Lock-grip pliers with concave jaws	134/250
1	Combination pliers	150 AX/180
1	Lay-on slip-joint adjustable pliers	178 N/250
1	Hacksaw	200
13	Set of 13 double ended open jaw wrenches /6x7-8x9-10x11-12x13-14x15-16x17-18x19-20x22-21x23-24x26-25x28-27x29-30x32	252 N/SR13
16	Oil draining kit (16 pcs.)	263/S16
3	Assortment with hexagonal impact sockets for tyre rims with teflon protection in modular box (3 pcs.)/17-19-21	270 C/C3
4	Glowplug wrenches with jointed socket / 8L-9L-10L-12L	278 D
2	T-handle spark plug wrenches with jointed socket	278 N/16-20,8
9	Set of 9 angled hexagon keys/ 1,5-2-2,5-3-4-5-6-8-10	280 S9
17	Set of 17 combination wrenches/ 6-7-8-9-10-11-12-13-14-15-16-17-18-19-20-21-22	285 SE17

pcs	description	item/size
4	Screwdrivers for slot-head screws/ 0,5x3x75-0,8x4x100-1x5,5x125-1,2x6,5x150	324
1	Screwdrivers for slot-head screws / 0,4x2,5x50	324 D
1	Screwdrivers for slot-head screws / 1,2x6,5x35	324 N
1	Screwdrivers for PHILLIPS® screws	324 NPH/2x35
3	Screwdrivers for PHILLIPS® screws / 0,75-1x75-2x100	324 PH
7	Screwdrivers for TORX® Tamper Resistant screws /T10x75-T15x75-T20x100-T25x100-T27x100-T30x125-T40x150	324 STX
1	Mallets	376/35
1	Hammers for mechanics	382/300
1	Oilers	420/500
1	Fast oil-filter wrench (cars)	443 N
23	Assortment with hexagonal sockets in ABS case (23 pcs.)	606 1/2 EA
1	Pliers for CORBIN clamps	871/2
1	Thickness gauges	966/20

kg	code	
16	U04960021	1



## 496 B7



### Assortment for car repair (210 pcs.)

- Supplied with hooks and supports for cabinets 502
- Supplied without plastic trays



pcs	description	item/size
1	Pliers with straight nose for internal circlips	127 N/19÷60
1	Pliers with nose bent at 90° for internal circlips	127 PN/19÷60
1	Pliers with straight nose for external circlips	128 N/19÷60
1	Pliers with nose bent at 90° for external circlips	128 PN/19÷60
1	Half-round extra-long nose pliers with straight jaws	133 AX/160
1	Half-round extra-long nose pliers with jaws at 45°	133 AXP/160
1	Lock-grip pliers with concave jaws	134/250
1	Combination pliers	150 AX/180
1	Box-joint adjustable pliers	180 C/250
1	Diagonal cutting nippers	185 AX/160
1	Scissors for electricians, steel blades	207 C
1	Utility knife with snap-off blades	220 B1
9	Set of 9 socket bits for TORX® screws / T20-T25-T27-T30-T40-T45-T50-T55-T60	233 1/2 NTX/S9
7	Set of 7 TORX® sockets / E10-E12-E14-E16-E18-E20-E24	235 1/2 NTX/S7
13	Set of 13 double ended open jaw wrenches /6x7-8x9-10x11-12x13-14x15-16x17-18x19-20x22-21x23-24x26-25x28-27x29-30x32	252 N/SR13
16	Oil draining kit (16 pcs.)	263/S16
3	Assortment with hexagonal impact sockets for tyre rims with teflon protection in modular box (3 pcs.)/17-19-21	270 C/C3
8	T-handle wrenches with jointed hexagonal socket/7-8-10-11-13-14-17-19	276 CE
4	Glowplug wrenches with jointed socket / 8L-9L-10L-12L	278 D
2	Long T-handle spark plug wrenches with jointed socket/16-20,8	278 NL
3	Spark plug sockets/16-18-20,8	279 N 1/2
9	Set of 9 long angled hexagon keys with spherical head/1,5-2-2,5-3-4-5-6-8-10	280 LTS/S9
4	Combination wrenches/24-27-30-32	285
17	Set of 17 combination wrenches /6-7-8-9-10-11-12-13-14-15-16-17-18-19-20-21-22	285 SE17

pcs	description	item/size
4	Screwdrivers for slot-head screws/ 0,5x3x75-0,8x4x100-1x5,5x125-1,2x6,5x150	324
1	Screwdrivers for slot-head screws / 0,4x2,5x50	324 D
1	Screwdrivers for slot-head screws / 1,2x6,5x35	324 N
1	Screwdrivers for PHILLIPS® screws	324 NPH/2x35
3	Screwdrivers for PHILLIPS® screws / 0x75-1x75-2x100	324 PH
7	Screwdrivers for TORX® Tamper Resistant screws /T10x75-T15x75-T20x100-T25x100-T27x100-T30x125-T40x150	324 STX
1	Ribbed chisels	351/250
6	Assortment in plastic pouch (6 pcs.) / 362/125-150; 364/125; 366/3x125-4x150; 368/4x125	372 SE6
1	Mallets	376/35
2	Hammers for mechanics	382/300-500
1	Oilers	420/500
1	Fast oil-filter wrench (cars)	443 N
4	Cap wrenches for oil filters/65-66,5-74-74 A	446
1	Ball-joint extractors	449/22
1	Outside pullers with two jaws	454/1
23	Assortment with hexagonal sockets in ABS case (23 pcs.)	606 1/2 EA
38	Assortment with hexagonal sockets and bits in bimaterial box (38 pcs.)	609 1/4 EB
1	Crimping pliers for non-insulated open and closed terminals	746
1	Spring-clips pliers	870/12÷60
1	CLICK spring-clips pliers	871 B
1	Pliers for CORBIN clamps	871/2
1	Digital vernier caliper 1/100	960 D
1	Thickness gauges	966/20
1	Professional tape rules with shockproof covering	981 A/3

kg	code	img
35	U04960023	



## 496 C1

### Assortment for body repair (107 pcs.)

- Supplied without plastic trays



pcs	description	item/size
1	Lock-grip pliers with concave jaws	134/250
1	Lock-grip pliers with C-clamp jaws	139 AN/280
1	Combination pliers	150 AX/180
1	Lay-on slip-joint adjustable pliers	178 N/250
1	Heavy-duty diagonal cutting nippers	188 AX/160
1	Toggle joint shears for sheet steel	203 AN
9	Set of 9 angled hexagon keys/ 1,5-2-2,5-3-4-5-6-8-10	280 S9
17	Set of 17 combination wrenches/ 6-7-8-9-10-11-12-13-14-15-16-17-18-19-20-21-22	285 SE17
4	Screwdrivers for slot-head screws /0,5x3x75-0,8x4x100-1x5,5x125-1,2x6,5x150	324
1	Screwdrivers for slot-head screws / 1,6x8x175	324 E
1	Screwdrivers for PHILLIPS® screws/ 3x150	324 EPH
1	Screwdrivers for slot-head screws/ 0,8x4x35	324 N
1	Screwdrivers for PHILLIPS® screws	324 NPH/2x35
2	Screwdrivers for PHILLIPS® screws / 1x75-2x100	324 PH
1	Extra flat chisel	354
6	Assortment in plastic pouch (6 pcs.) / 362/125-150; 364/125; 366/3x125-4x150; 368/4x125	372 SE6
1	Mallets	376/35
1	Hammers for mechanics	382/500
1	Hammer with flat round and curved chisel heads	392

pcs	description	item/size
1	Hammer with flat round and flat square heads	393/32
1	Comma shaped wedged dolly	401
1	Large grooved dolly	401 A
1	Dolly for body repair	402 A
1	Dolly for body repair	402 B
1	Dolly for body repair	402 C
1	Dolly for body repair	404
1	Double spoon with one curved blade and a flat one	410 C
1	Facing narrow body spoon, long model	411
1	Light curved spoon, short model	412
1	Flat serrated spoon for thinning out operations	412 B
1	Adjustable file holder	416 N
2	Flat flexible files/3,5-3,4	416 NA
1	Pressure trim clips removal lever	426 N
1	Rolling head bar	429/400
38	Assortment with hexagonal sockets and bits in bimaterial box (38 pcs.)	609 1/4 EB
1	Metal brush	993 A

kg	code	img
24	U04960027	



### 496 D1

#### Assortment for earth moving machines (151 pcs.)

- Supplied without plastic trays



pcs	description	item/size
1	Pliers with straight nose for internal circlips	127 N/19÷60
1	Pliers with straight nose for external circlips	128 N/19÷60
1	Half-round extra-long nose pliers with straight jaws	133 AX/160
1	Lock-grip pliers with concave jaws	134/250
1	Combination pliers	150 AX/180
1	Box-joint adjustable pliers	180 C/250
1	Heavy-duty diagonal cutting nippers	188 AX/160
1	Hacksaw	200 S
1	Shears for sheet steel	204/250
1	Scissors for electricians, steel blades	207 C
16	Hexagonal sockets / 22-23-24-26-27-28-30-32-33-34-36-38-41-46-50-55	235 3/4 EN
1	Extensions	236 3/4/200
1	Reversible ratchet	237 A 3/4
1	T-handle with sliding square drive	240 3/4 N
1	Universal joint	241 3/4
13	Set of 13 double ended open jaw wrenches /6x7-8x9-10x11-12x13-14x15-16x17-18x19-20x22-21x23-24x26-25x28-27x29-30x32	252 N/SR13
12	Set of 12 angled hexagon keys/ 2÷10	280 SE12
13	Set of 13 offset bihexagonal ring wrenches /6x7-8x9-10x11-12x13-14x15-16x17-18x19-20x22-21x23-24x26-25x28-27x29-30x32	283 SE13
4	Combination wrenches/24-27-30-32	285
17	Set of 17 combination wrenches/ 6-7-8-9-10-11-12-13-14-15-16-17-18-19-20-21-22	285 SE17

pcs	description	item/size
4	Screwdrivers for slot-head screws/ 0,5x3x75- 0,8x4x100-1x5,5x125-1,2x6,5x150	324
1	Screwdrivers for slot-head screws/ 1,6x8x175	324 E
1	Screwdrivers for PHILLIPS® screws/3x150	324 EPH
1	Screwdrivers for slot-head screws/ 0,8x4x35	324 N
1	Screwdrivers for PHILLIPS® screws	324 NPH/2x35
2	Screwdrivers for PHILLIPS® screws/ 1x75-2x100	324 PH
2	Ribbed chisels	351/150-200
6	Set of 6 pin punches	367 SE6
6	Assortment in plastic pouch (6 pcs.) /362/125-150; 364/125; 366/3x125-4x150; 368/4x125	372 SE6
1	Non-rebound mallets	374 N/35
2	Hammers for mechanics	382/300-500
1	Oilers	420/500
1	Crowbar	428/400
1	Rolling head bar	429/400
1	Flexible retrievers with magnetic head	442 N/1
1	Fast oil-filter wrench (cars)	443 N
23	Assortment with hexagonal sockets in ABS case (23 pcs.)	606 1/2 EA
1	Thickness gauges	966/19 L
1	Professional tape rules with shockproof covering	981 A/3
5	Set of five files (990 M PA÷M PE)	990 M2/SE5

kg	code	
33	U04960031	1

### 496 E1

#### Assortment for industrial maintenance (95 pcs.)

- Supplied without plastic trays



pcs	description	item/size
1	Pliers with straight nose for internal circlips	127 N/19÷60
1	Pliers with straight nose for external circlips	128 N/19÷60
1	Half-round extra-long nose pliers with straight jaws	133 AX/160
1	Lock-grip pliers with concave jaws	134/250
1	Combination pliers	150 AX/180
1	Box-joint adjustable pliers	180 C/250
1	Heavy-duty diagonal cutting nippers	188 AX/160
1	Hacksaw	200 S
1	Shears for sheet steel	204/250
1	Scissors for electricians, steel blades	207 C
1	Utility knife with snap-off blades	220 B1
8	Set of 8 double ended open jaw wrenches /6x7-8x9-10x11-12x13-14x15-16x17-18x19-20x22	252 N/SR8
9	Set of 9 long angled hexagon keys with spherical head/1,5-2-2,5-3-4-5-6-8-10	280 LTS/S9
17	Set of 17 combination wrenches/ 6-7-8-9-10-11-12-13-14-15-16-17-18-19-20-21-22	285 SE17
1	Phase-testing screwdriver 110÷250V	321 F
4	Screwdrivers for slot-head screws/ 0,5x3x75-0,8x4x100-1x5,5x125-1,2x6,5x150	324
1	Screwdrivers for slot-head screws/1,6x8x175	324 E
1	Screwdrivers for slot-head screws/0,8x4x35	324 N
1	Screwdrivers for PHILLIPS® screws	324 NPH/2x35
2	Screwdrivers for PHILLIPS® screws/ 1x75-2x100	324 PH
1	Ribbed chisels	351/200
6	Set of 6 pin punches	367 SE6
1	Centre punches	368/4x125
1	Mallets	376/35
1	Hammers for mechanics	382/500
1	Oilers	420/500
23	Assortment with hexagonal sockets in ABS case (23 pcs.)	606 1/2 EA
1	Professional tape rules with shockproof covering	981 A/3
5	Set of five files (990 M PA÷M PE)	990 M2/SE5

kg	code	
20	U04960038	1

### 496 EP1

#### Assortment for industrial maintenance (81 pcs.)

- Supplied without plastic trays

pcs	description	item/size
1	Pliers with straight nose for internal circlips	127 N/19÷60
1	Pliers with straight nose for external circlips	128 N/19÷60
1	Half-round extra-long nose pliers with straight jaws	133 AX/160
1	Lock-grip pliers with concave jaws	134/250
1	Combination pliers	150 AX/180
1	Box-joint adjustable pliers	180 C/250
1	Heavy-duty diagonal cutting nippers	188 AX/160
1	Hacksaw	200 S
1	Shears for sheet steel	204/250
1	Scissors for electricians, steel blades	207 C
1	Utility knife with snap-off blades	220 B1
7	Set of 7 double ended open jaw wrenches, inch sizes/1/4÷1 1/8"	252 NP/SE7
8	Set of 8 long angled hexagon keys with spherical head, inch sizes /3/32-1/8-5/32-3/16-7/32-1/4-5/16-3/8"	280 LTSP/S8
13	Set of 13 combination wrenches, inch sizes/1/4÷1"	285 P/SE13
1	Phase-testing screwdriver 110÷250V	321 F
4	Screwdrivers for slot-head screws/ 0,5x3x75-0,8x4x100-1x5,5x125-1,2x6,5x150	324
1	Screwdrivers for slot-head screws/1,6x8x175	324 E
1	Screwdrivers for slot-head screws/0,8x4x35	324 N
1	Screwdrivers for PHILLIPS® screws	324 NPH/2x35
2	Screwdrivers for PHILLIPS® screws/ 1x75-2x100	324 PH
1	Ribbed chisels	351/200
6	Set of 6 pin punches	367 SE6
1	Centre punches	368/4x125
1	Mallets	376/35
1	Hammers for mechanics	382/500
1	Oilers	420/500
15	Assortment with bihexagonal sockets in ABS case, in inches (15 pcs.)	606 1/2 APOL
1	Professional tape rules with shockproof covering	981 A/3
5	Set of five files (990 M PA÷M PE)	990 M2/SE5

kg	code	
18	U04960039	1



### 496 E2 <sup>mm</sup>



#### Assortment for industrial maintenance (149 pcs.)

- Supplied without plastic trays



pcs	description	item/size
1	Pliers with straight nose for internal circlips	127 N/19÷60
1	Pliers with nose bent at 90° for internal circlips	127 PN/19÷60
1	Pliers with straight nose for external circlips	128 N/19÷60
1	Pliers with nose bent at 90° for external circlips	128 PN/19÷60
1	Half-round extra-long nose pliers with straight jaws	133 AX/160
1	Lock-grip pliers with concave jaws	134/250
1	Combination pliers	150 AX/180
1	Box-joint adjustable pliers	180 C/250
1	Heavy-duty diagonal cutting nippers	188 AX/160
1	Hacksaw	200 S
1	Shears for sheet steel	204/250
1	Scissors for electricians, steel blades	207 C
1	Utility knife with snap-off blades	220 B1
13	Set of 13 double ended open jaw wrenches /6x7-8x9-10x11-12x13-14x15-16x17-18x19-20x22-21x23-24x26-25x28-27x29-30x32	252 N/SR13
9	Set of 9 long angled hexagon keys with spherical head/1,5-2-2,5-3-4-5-6-8-10	280 LTS/S9
4	Combination wrenches/24-27-30-32	285
17	Set of 17 combination wrenches /6-7-8-9-10-11-12-13-14-15-16-17-18-19-20-21-22	285 SE17
1	Phase-testing screwdriver 110÷250V	321 F
4	Screwdrivers for slot-head screws/ 0,5x3x75-0,8x4x100-1x5,5x125-1,2x6,5x150	324

pcs	description	item/size
1	Screwdrivers for slot-head screws/ 1,6x8x175	324 E
2	Screwdrivers for slot-head screws/ 0,8x4x35-1,2x6,5x35	324 N
2	Screwdrivers for PHILLIPS® screws/ 1x35-2x35	324 NPH
3	Screwdrivers for PHILLIPS® screws/ 0x75-1x75-2x100	324 PH
2	Ribbed chisels	351/200-250
1	Chisels	362/150
6	Set of 6 pin punches	367 SE6
1	Centre punches	368/4x125
1	Mallets	376/35
1	Hammers for mechanics	382/500
1	Oilers	420/500
23	Assortment with hexagonal sockets in ABS case (23 pcs.)	606 1/2 EA
38	Assortment with hexagonal sockets and bits in bimaterial box (38 pcs.)	609 1/4 EB
1	Professional tape rules with shockproof covering	981 A/3
5	Set of five files (990 M PA÷M PE)	990 M2/SE5

kg	code	img
25	U04960040	



### 496 E3 <sup>mm</sup>



#### Assortment for industrial maintenance (186 pcs.)

- Supplied without plastic trays



pcs	description	item/size
2	Pliers with straight nose for internal circlips/ 12÷25-19÷60	127 N
2	Pliers with nose bent at 90° for internal circlips/12÷25-19÷60	127 PN
2	Pliers with straight nose for external circlips/10÷25-19÷60	128 N
2	Pliers with nose bent at 90° for external circlips/10÷25-19÷60	128 PN
1	Half-round extra-long nose pliers with straight jaws	133 AX/160
1	Half-round extra-long nose pliers with jaws at 45°	133 AXP/160
1	Lock-grip pliers with concave jaws	134/250
1	Combination pliers	150 AX/180
1	Box-joint adjustable pliers	180 C/250
1	Heavy-duty diagonal cutting nippers	188 AX/160
1	Hacksaw	200 S
1	Shears for sheet steel	204/250
1	Scissors for electricians, steel blades	207 C
1	Utility knife with snap-off blades	220 B1
13	Set of 13 double ended open jaw wrenches /6x7-8x9-10x11-12x13-14x15-16x17-18x19-20x22-21x23-24x26-25x28-27x29-30x32	252 N/SR13
1	T-handle key with jointed square drive	273 1/2 Q
9	Set of 9 long angled hexagon keys with spherical head/1,5-2-2,5-3-4-5-6-8-10	280 LTS/S9
26	Set of 26 combination wrenches/ 6-7-8-9-10-11-12-13-14-15-16-17-18-19-20-21-22-23-24-25-26-27-28-29-30-32	285 SE26
1	Adjustable wrenches with quick adjustment	294 AD/250
1	Phase-testing screwdriver 110÷250V	321 F
4	Screwdrivers for slot-head screws/ 0,5x3x75-0,8x4x100-1x5,5x125-1,2x6,5x150	324
3	Screwdrivers for slot-head screws / 1,6x8x175-1,6x10x175-2x12x250	324 E
1	Screwdrivers for PHILLIPS® screws / 3x150	324 EPH

pcs	description	item/size
2	Screwdrivers for slot-head screws / 0,8x4x35-1,2x6,5x35	324 N
2	Screwdrivers for PHILLIPS® screws/ 1x35-2x35	324 NPH
3	Screwdrivers for PHILLIPS® screws/ 0x75-1x75-2x100	324 PH
8	Set of 8 screwdrivers for slot-head and PHILLIPS® screws	329 N/S8
2	Ribbed chisels	351/200-250
1	Chisels	362/150
6	Set of 6 pin punches	367 SE6
2	Centre punches/4x125-5x150	368
1	Mallets	376/35
1	Hammers for mechanics	382/500
1	Oilers	420/500
1	Flexible retrievers with magnetic head	442 N/2
1	Outside pullers with two jaws	454/2
6	Set of 6 conical extractors	458 S6
23	Assortment with hexagonal sockets in ABS case (23 pcs.)	606 1/2 EA
38	Assortment with hexagonal sockets and bits in bimaterial box (38 pcs.)	609 1/4 EB
2	Ratchet tap wrenches	618/1-2
1	Vernier caliper / 1/20 mm	960
1	Thickness gauges with long blades	966 L/19
1	Professional tape rules with shockproof covering	981 A/3
5	Set of five files (990 M PA÷M PE)	990 M2/SE5
1	Metal brush	993 A

kg	code	img
30	U04960042	



## 496 EP3



### Assortment for industrial maintenance (130 pcs.)

- Supplied without plastic trays

pcs	description	item/size
2	Pliers with straight nose for internal circlips/19÷60-12÷25	127 N
2	Pliers with nose bent at 90° for internal circlips/19÷60-12÷25	127 PN
2	Pliers with straight nose for external circlips/19÷60-10÷25	128 N
2	Pliers with nose bent at 90° for external circlips/19÷60-10÷25	128 PN
1	Half-round extra-long nose pliers with straight jaws	133 AX/160
1	Half-round extra-long nose pliers with jaws at 45°	133 AXP/180
1	Lock-grip pliers with concave jaws	134/250
1	Combination pliers	150 AX/180
1	Box-joint adjustable pliers	180 C/250
1	Heavy-duty diagonal cutting nippers	188 AX/160
1	Hacksaw	200 S
1	Shears for sheet steel	204/250
1	Scissors for electricians, steel blades	207 C
1	Utility knife with snap-off blades	220 B1
13	Double ended open jaw wrenches, inch sizes/1/4x5/16-1 1/4x1 3/8	252 NP

pcs	description	item/size
1	T-handle key with jointed square drive	273 1/2 Q
8	Set of 8 long angled hexagon keys with spherical head, inch sizes / 3/32-1/8-5/32-3/16-7/32-1/4-5/16-3/8	280 LTSP/S8
17	Combination wrenches, inch sizes/1/4÷1 5/16	285 P
1	Adjustable wrenches with quick adjustment	294 AD/250
1	Phase-testing screwdriver 110÷250V	321 F
4	Screwdrivers for slot-head screws/ 0,5x3x75-0,8x4x100-1x5,5x125-1,2x6,5x150	324
3	Screwdrivers for slot-head screws/ 1,6x8x175-1,6x10x175-2x12x250	324 E
1	Screwdrivers for PHILLIPS® screws/3x150	324 EPH
2	Screwdrivers for slot-head screws / 0,8x4x35-1,2x6,5x35	324 N
2	Screwdrivers for PHILLIPS® screws/ 1x35-2x35	324 NPH
3	Screwdrivers for PHILLIPS® screws/ 0x75-1x75-2x100	324 PH
8	Set of 8 screwdrivers for slot-head and PHILLIPS® screws	329 N/S8
2	Ribbed chisels	351/200-250
1	Chisels	362/150

pcs	description	item/size
6	Set of 6 pin punches	367 SE6
2	Centre punches/4x125-5x150	368
1	Mallets	376/35
1	Hammers for mechanics	382/500
1	Oilers	420/500
1	Flexible retrievers with magnetic head	442 N/2
1	Outside pullers with two jaws	454/2
6	Set of 6 conical extractors	458 S6
15	Assortment with bihexagonal sockets in ABS case, in inches (15 pcs.)	606 1/2 APOL
2	Ratchet tap wrenches	618/1-2
1	Vernier caliper to 1/20 mm	960
1	Thickness gauges with long blades	966 L/19
1	Professional tape rules with shockproof covering	981 A/3
5	Set of five files (990 M PA÷M PE)	990 M2/SE5
1	Metal brush	993 A

kg	code	
28	U04960043	1



## 496 E4



### Assortment for industrial maintenance (256 pcs.)

- Supplied without plastic trays



pcs	description	item/size
3	Pliers with straight nose for internal circlips/19÷60-12÷25-40÷100	127 N
3	Pliers with nose bent at 90° for internal circlips/19÷60-12÷25-40÷100	127 PN
3	Pliers with straight nose for external circlips/19÷60-10÷25-40÷100	128 N
3	Pliers with nose bent at 90° for external circlips/19÷60-10÷25-40÷100	128 PN
1	Half-round extra-long nose pliers with straight jaws	133 AX/160
1	Half-round extra-long nose pliers with jaws at 45°	133 AXP/160
1	Lock-grip pliers with concave jaws	134/250
1	Lock-grip rack-type pliers with long jaws	135 B/250
1	Wire strippers	147 AX/160
1	Combination pliers	150 AX/180
1	Box-joint adjustable pliers	180 C/250
1	Heavy-duty diagonal cutting nippers	188 AX/160
1	Hacksaw	200 S
1	Hacksaw	201
1	Shears for sheet steel	204/250
1	Scissors for electricians, steel blades	207 C
1	Utility knife with snap-off blades	220 B1
8	Socket bits for hex socket screws/ 5-6-7-8-10-11-12-14-17	234 1/2 N
10	Hexagonal sockets/ 22-24-27-30-32-36-38-41-46-50	235 3/4 EN
2	Extensions/200-400	236 3/4
1	Reversible ratchet	237 A 3/4
1	T-handle with sliding square drive	240 3/4 N
1	Universal joint	241 3/4
1	Double ended open jaw wrenches	252 N/36x41
13	Set of 13 double ended open jaw wrenches /6x7-8x9-10x11-12x13-14x15-16x17-18x19-20x22-21x23-24x26-25x28-27x29-30x32	252 N/SR13
1	T-handle key with jointed square drive	273 1/2 Q
9	Set of 9 long angled hexagon keys with spherical head/1,5-2-2,5-3-4-5-6-8-10	280 LTS/S9
10	T-handle hexagon keys/2-2,5-3-4-5-6-8-10-12-14	280 T
13	Set of 13 offset bihexagonal ring wrenches /6x7-8x9-10x11-12x13-14x15-16x17-18x19-20x22-21x23-24x26-25x28-27x29-30x32	283 SE13
3	Combination wrenches	285/36-38-41
26	Set of 26 combination wrenches / 6-7-8-9-10-11-12-13-14-15-16-17-18-19-20-21-22-23-24-25-26-27-28-29-30-32	285 SE26
1	Adjustable wrenches with quick adjustment	294 AD/250
1	American model pipe wrenches	302 N/350-2

pcs	description	item/size
1	Swedish model pipe wrenches with thin, shaped jaws bent to 45°	310 N/430-1/2
1	Phase-testing screwdriver 110÷250V	321 F
4	Screwdrivers for slot-head screws /0,5x3x75-0,8x4x100-1x5,5x125-1,2x6,5x150	324
3	Screwdrivers for slot-head screws / 1,6x8x175-1,6x10x175-2x12x250	324 E
1	Screwdrivers for PHILLIPS® screws/3x150	324 EPH
2	Screwdrivers for slot-head screws/0,8x4x35-1,2x6,5x35	324 N
2	Screwdrivers for PHILLIPS® screws/ 1x35-2x35	324 NPH
3	Screwdrivers for PHILLIPS® screws / 0x75-1x75-2x100	324 PH
8	Set of 8 screwdrivers for slot-head and PHILLIPS® screws	329 N/S8
2	Ribbed chisels	351/200-250
1	Chisels	362/150
1	Cross cut chisel	364/125
6	Set of 6 pin punches	367 SE6
2	Centre punches/4x125-5x150	368
2	Mallets	376/35-50
3	Hammers for mechanics/300-500-1000	382
1	Oilers	420/500
1	Crowbar	428/400
1	Flexible retrievers with magnetic head	442 N/2
2	Outside pullers with two jaws	454/2-4
6	Set of 6 conical extractors	458 S6/1÷6
23	Assortment with hexagonal sockets in ABS case (23 pcs.)	606 1/2 EA
38	Assortment with hexagonal sockets and bits in bimaterial box (38 pcs.)	609 1/4 EB
2	Ratchet tap wrenches	618/1-2
1	Crimping pliers for pre-insulated terminals	751
1	Torque wrenches with reversible ratchet	810 N/200
1	Vernier caliper to 1/20 mm	960
1	Thickness gauges with long blades	966 L/19
1	Scriber	974
1	Semi-rigid graduated rules	978 B/300
1	Professional tape rules with shockproof covering	981 A/3
5	Set of five files (990 M PA÷M PE)	990 M2/SE5
1	Metal brush	993 A
1	Hand riveter	995 A

kg	code	
45	U04960044	1



### 496 E6



#### Assortment for industrial maintenance (124 pcs.)

- Supplied with hooks and supports for cabinets 502
- Supplied without plastic trays



pcs	description	item/size
1	Insulating tape	073/19x25
1	Pliers with straight nose for internal circlips	127 N/19÷60
1	Pliers with nose bent at 90° for internal circlips	127 PN/19÷60
1	Pliers with straight nose for external circlips	128 N/19÷60
1	Pliers with nose bent at 90° for external circlips	128 PN/19÷60
1	Half-round extra-long nose pliers with straight jaws	133 AX/160
1	Half-round extra-long nose pliers with jaws at 45°	133 AXP/160
1	Lock-grip pliers with concave jaws	134/250
1	Combination pliers	150 AX/180
1	Box-joint adjustable pliers	180 C/250
1	Diagonal cutting nippers	185 AX/160
1	Hacksaw	200
1	Shears for sheet steel	204/250
1	Scissors for electricians, steel blades	207 C
1	Utility knife with snap-off blades	220 B1
1	T-handle key with jointed square drive	273 1/2 Q
9	Set of 9 angled hexagon keys/1,5-2-2,5-3-4-5-6-8-10	280 S9
7	T-handle hexagon keys/2-2,5-3-4-5-6-8	280 T
2	Combination wrenches	285/24-27
17	Set of 17 combination wrenches/6-7-8-9-10-11-12-13-14-15-16-17-18-19-20-21-22	285 SE17
1	Adjustable wrenches with quick adjustment	294 AD/250
1	Swedish model pipe wrenches with thin, shaped jaws bent to 45°/430-1 1/2"	310 N
1	Tube cutter for Copper and light alloy tubes	314 DA
1	Phase-testing screwdriver 110÷250V	321 F
4	Screwdrivers for slot-head screws/0,5x3x75-0,8x4x100-1x5,5x125-1,2x6,5x150	324

pcs	description	item/size
1	Screwdrivers for slot-head screws/0,4x2,5x50	324 D
1	Screwdrivers for slot-head screws/1,2x6,5x35	324 N
1	Screwdrivers for PHILLIPS® screws	324 NPH/2x35
3	Screwdrivers for PHILLIPS® screws/0x75-1x75-2x100	324 PH
2	Ribbed chisels	351/200-250
6	Set of 6 pin punches	367 SE6
7	Assortment with metal holder (7 pcs.) / 362/125-150 364/125-150 366/3x125-4x150 368/4x125	372 S7
1	Mallets	376/35
1	Hammers for mechanics	382/300
1	Oilers	420/500
1	Crowbar	428/400
1	Flexible retrievers with magnetic head	442 N/1
23	Assortment with hexagonal sockets in ABS case (23 pcs.)	606 1/2 EA
2	Ratchet tap wrenches	618/1-2
1	Crimping pliers for non-insulated open and closed terminals	746
1	Digital vernier caliper 1/100	960 D
1	Thickness gauges	966/20
1	Retractable carbide scriber	974 BN
1	Semi-rigid graduated rules	978 B/300
1	Professional tape rules with shockproof covering	981 A/3
5	Set of five files (990 M PA÷M PE)	990 M2/SE5
1	Metal brush	993 A
1	Brush	994 B/40x15
1	Hand riveter	995 A

kg	code	
23	U04960046	1



### 496 E7



#### Assortment for industrial maintenance (209 pcs.)

- Supplied with hooks and supports for cabinets 502
- Supplied without plastic trays



pcs	description	item/size
1	Insulating tape	073/19x25
2	Pliers with straight nose for internal circlips/12÷25-19÷60	127 N
2	Pliers with nose bent at 90° for internal circlips/12÷25-19÷60	127 PN
2	Pliers with straight nose for external circlips/10÷25-19÷60	128 N
2	Pliers with nose bent at 90° for external circlips/10÷25-19÷60	128 PN
1	Half-round extra-long nose pliers with straight jaws	133 AX/160
1	Half-round extra-long nose pliers with jaws at 45°	133 AXP/160
1	Lock-grip pliers with concave jaws	134/250
1	Combination pliers	150 AX/160
1	Box-joint adjustable pliers	180 C/250
1	Diagonal cutting nippers	185 AX/160
1	Hacksaw	200 S
1	Hacksaw	201
1	Shears for sheet steel	204/250
1	Scissors for electricians, steel blades	207 C
1	Multi-purpose scissors	211 A
1	Utility knife with snap-off blades	220 B1
8	Set of 8 socket bits for hex socket screws/5-6-7-8-10-12-14-17	234 1/2 N/S8
13	Set of 13 double ended open jaw wrenches/6x7-8x9-10x11-12x13-14x15-16x17-18x19-20x22-21x23-24x26-25x28-27x29-30x32	252 N/SR13
1	T-handle key with jointed square drive	273 1/2 Q
9	Set of 9 long angled hexagon keys with spherical head/1,5-2-2,5-3-4-5-6-8-10	280 LTS/S9
7	T-handle hexagon keys/2-2,5-3-4-5-6-8	280 T
4	Combination wrenches/24-27-30-32	285
17	Set of 17 combination wrenches /6-7-8-9-10-11-12-13-14-15-16-17-18-19-20-21-22	285 SE17
1	Adjustable wrenches with quick adjustment	294 AD/250
1	Swedish model pipe wrenches with thin, shaped jaws bent to 45°/430-1 1/2"	310 N
1	Tube cutter for Copper and light alloy tubes	314 DA
1	Phase-testing screwdriver 110÷250V	321 F
4	Screwdrivers for slot-head screws/0,5x3x75-0,8x4x100-1x5,5x125-1,2x6,5x150	324

pcs	description	item/size
1	Screwdrivers for slot-head screws/0,4x2,5x50	324 D
1	Screwdrivers for slot-head screws /1,2x6,5x35	324 N
1	Screwdrivers for PHILLIPS® screws	324 NPH/2x35
3	Screwdrivers for PHILLIPS® screws/0x75-1x75-2x100	324 PH
8	Set of 8 screwdrivers for slot-head and PHILLIPS® screws	329 N/S8
2	Ribbed chisels	351/200-250
6	Set of 6 pin punches	367 SE6
6	Assortment in plastic pouch (6 pcs.) / 362/125-150; 364/125; 366/3x125-4x150; 368/4x125	372 SE6
1	Mallets	376/35
2	Hammers for mechanics	382/300-500
1	Oilers	420/500
1	Crowbar	428/400
1	Flexible retrievers with magnetic head	442 N/1
1	Outside pullers with two jaws	454/2
6	Set of 6 conical extractors	458 S6/1÷6
23	Assortment with hexagonal sockets in ABS case (23 pcs.)	606 1/2 EA
38	Assortment with hexagonal sockets and bits 609 1/4 EB in bimaterial box (38 pcs.)	609 1/4 EB
2	Ratchet tap wrenches	618/1-2
1	Crimping pliers for pre-insulated terminals	751
1	Torque wrenches with reversible ratchet	810 N/200
1	Digital vernier caliper 1/100	960 D
1	Thickness gauges	966/20
1	Retractable carbide scriber	974 BN
1	Semi-rigid graduated rules	978 B/300
1	Professional tape rules with shockproof covering	981 A/5
1	Flexible scrapers	987 E/50
1	Rigid scrapers	987 F/50
5	Set of five files (990 M PA÷M PE)	990 M2/SE5
1	Metal brush	993 A
1	Brush	994 B/40x15
1	Hand riveter	995 A

kg	code	
27	U04960048	1

**496 F2** **Assortment for electronics (126 pcs.)**

- Supplied without plastic trays



pcs	description	item/size
1	Flat extra-long nose pliers with straight jaws	015/5
1	Half-round short nose pliers with jaws at 60°	017/2
1	Half-round long nose pliers with straight jaws	017/3
1	Ultra compact cutting nippers with flush cutting edge	022/1
1	Compact cutting nippers with flush cutting edge	022/3
1	Cutting nippers with flush cutting edge at 30°	033/2
1	Tweezers with strong rigid tips	040/1A
1	Tweezers with straight tips and guide pin	042
1	Tweezers with tips at 45° and guide pin	042 P
1	Spring puller	053 N
1	Pen oiler	054
1	Articulated mirror	056/1
1	Suction desoldering pump	065 C
1	Half-round extra-long nose pliers with straight jaws	133 AX/160
1	Wire strippers	147 AX/160
1	Combination pliers	150 AX/180
1	Scissors for electricians, steel blades	207 C
1	Knife for electricians	216 N
1	Utility knife with snap-off blades	220 B1
12	Set of 12 small double ended open jaw wrenches /3,2-4-4,5-5-5,5-6-7-8-10-12-13-14	250 N/SE12
9	Set of 9 angled hexagon keys/ 1,5-2-2,5-3-4-5-6-8-10	280 S9
8	Set of 8 keys for TORX® Tamper Resistant screws	280 STX/S8
1	Adjustable wrenches with quick adjustment	294 AD/150
1	Phase-testing screwdriver 110÷250V	321 F
4	Screwdrivers for slot-head screws / 0,6x3,5x100-0,8x4x100-1x5,5x125-1,2x6,5x150	324 D
1	Screwdrivers for slot-head screws / 0,8x4x35	324 N
2	Screwdrivers for PHILLIPS® screws / 1x35-2x35	324 NPH

pcs	description	item/size
1	Screwdrivers for PHILLIPS® screws	324 PH/2x100
3	Screwdrivers for POZIDRIV®-SUPADRIV® screws/Ox75-1x75-2x100	324 PZ
8	Set of 8 screwdrivers for slot-head and PHILLIPS® screws	329 N/S8
1	Mallets	376/28
1	Hammers for mechanics	382/200
38	Assortment with hexagonal sockets and bits in bimaterial box (38 pcs.)	609 1/4 EB
1	Pen-type LED torch in Aluminium - 110 Lumen	889 TS
1	Scriber	974
1	Flexible graduated rules	978 A/150
1	Professional tape rules with shockproof covering	981 A/3
12	Set of 12 needle files	991 SE12
1	Brush	994 A

kg	code	img
6,1	U04960055	

**496 H** **1000 V****Assortment for electronics (94 pcs.)**

- Supplied without plastic trays



pcs	description	item/size
1	Spring puller	053 N
1	Rigid mirror	056/1
1	Insulating tape	073/15x10
2	Screwdrivers for slot-head screws - 1000 V /0,8x4x100-1,2x6,5x150	091
1	Screwdrivers for PHILLIPS® screws - 1000 V/2x125	091 PH
1	Pliers with straight nose for internal circlips	127 N/19÷60
1	Pliers with straight nose for external circlips	128 N/19÷60
1	Half-round extra-long nose pliers with straight jaws	133 AX/160
1	Wire strippers	147 AX/160
1	Combination pliers	150 AX/180
1	Lay-on slip-joint adjustable pliers	178 N/250
1	Hacksaw	201
1	Scissors for electricians, steel blades	207 C
9	Set of 9 angled hexagon keys/ 1,5-2-2,5-3-4-5-6-8-10	280 S9
8	Combination wrenches /8-10-11-13-14-17-19-22	285
1	Phase-testing screwdriver 110÷250V	321 F
1	Reversible screwdriver for slot-head and PHILLIPS® screws	322 R/1x6x75
8	Set of 8 screwdrivers for slot-head and PHILLIPS® screws	329 N/S8
1	Chisels for electricians	359/14x250
2	Pin punches/4x145-6x180	367
1	Centre punches	368/4x125
1	Mallets	376/35
1	Hammers for mechanics	382/300

pcs	description	item/size
1	Oilers	418/70
38	Assortment with hexagonal sockets and bits in bimaterial box (38 pcs.)	609 1/4 EB
1	Crimping pliers for pre-insulated terminals	747
1	Pen-type LED torch in Aluminium - 110 Lumen	889 TS
1	Scriber	974
1	Professional tape rules with shockproof covering	981 A/3
1	Flat needle file with flat edges	991 A
1	Triangular needle file	991 B
1	Round needle file	991 C
1	Brush	994 A

kg	code	img
6	U04960070	



## 496 H2 <sup>mm</sup> 1000 V



### Assortment for electrotechnics (85 pcs.)

- Supplied without plastic trays



pcs	description	item/size
1	Spring puller	053 N
1	Rigid mirror	056
1	Insulating tape	073/15x10
1	Half-round extra-long nose pliers with straight jaws - 1000 V	081 EX/160
1	Combination pliers - 1000 V	085 EX/180
1	Diagonal cutting nippers - 1000 V	087 EX/160
5	Screwdrivers for slot-head screws - 1000 V /0,4x2,5x50-0,5x3x75-0,8x4x100-1x5,5x125-1,2x6,5x150	091
3	Screwdrivers for PHILLIPS® screws - 1000 V /0x75-1x100-2x125	091 PH
1	Wire stripper with adjustable blade and cutter	161 A2
1	Lay-on slip-joint adjustable pliers	178 N/250
1	Hacksaw	201
1	Scissors for electricians, steel blades	207 C
1	Knife for electricians	216 N
1	Utility knife with snap-off blades	220 B1
8	Set of 8 double ended open jaw wrenches /6x7-8x9-10x11-12x13-14x15-16x17-18x19-20x22	252 N/SR8
9	Set of 9 angled hexagon keys/ 1,5-2-2,5-3-4-5-6-8-10	280 S9
8	Set of 8 keys for TORX® Tamper Resistant screws	280 STX/S8
6	Hexagonal socket spinners with grip/ 5,5-6-7-8-10-13	299
1	Phase-testing screwdriver 110÷250V	321 F
1	Screwdrivers for slot-head screws / 0,8x4x35	324 N
2	Screwdrivers for PHILLIPS® screws / 1x35-2x35	324 NPH

pcs	description	item/size
3	Screwdrivers for POZIDRIV®-SUPADRIV® screws/0x75-1x75-2x100	324 PZ
1	Extra flat chisel	354
2	Chisels for electricians/14x200-14x250	359
4	Pin punches/2x115-3x125-4x145-5x165	367
1	Centre punches	368/4x125
1	Mallets	376/35
1	Hammers for mechanics	382/300
1	Oilers	418/70
1	Cable ties pliers	765
4	Cable ties /100*2,5x98-100*3,6x140-100*4,8x360-100*7,8x365	765 EN
1	Pen-type LED torch in Aluminium - 110 Lumen	889 TS
1	Scriber	974
1	Professional tape rules with shockproof covering	981 A/3
1	Rigid scrapers	987 F/50
6	Set of 6 needle files	991 SE/1
1	Brush	994 A

kg	code	
9,1	U04960071	1



## 496 I <sup>mm</sup> 1000 V



### Assortment for electrotechnics (56 pcs.)

- Supplied without plastic trays



pcs	description	item/size
1	Tweezers with straight tips and guide pin	042
1	Insulating tape	073/15x10
5	Screwdrivers for slot-head screws - 1000 V /0,4x2,5x50-0,6x3,5x100-0,8x4x100-1x5,5x150-1,2x6,5x125	091
3	Screwdrivers for PHILLIPS® screws - 1000 V/0x75-1x100-2x125	091 PH
1	Flat extra-long nose pliers with straight jaws	131 AX/160
1	Half-round extra-long nose pliers with straight jaws	133 AX/160
1	Half-round extra-long nose pliers with jaws at 45°	133 AXP/160
1	Wire strippers	147 AX/160
1	Combination pliers	150 AX/180
1	Lay-on slip-joint adjustable pliers	178 N/250
1	Diagonal cutting nippers	185 AX/160
1	Hacksaw	201
1	Scissors for electricians, steel blades	207 C
1	Knife for electricians	216 N
8	Set of 8 double ended open jaw wrenches /6x7-8x9-10x11-12x13-14x15-16x17-18x19-20x22	252 N/SR8
9	Set of 9 angled hexagon keys/ 1,5-2-2,5-3-4-5-6-8-10	280 S9
6	Hexagonal socket spinners with grip/ 5,5-6-7-8-10	299
1	Phase-testing screwdriver 110÷250V	321 F
1	Screwdrivers for slot-head screws / 0,8x4x300	324 L

pcs	description	item/size
1	Extra flat chisel	354/235
2	Chisels for electricians/14x200-14x250	359
2	Pin punches/4x145-6x180	367
1	Centre punches	368/4x125
1	Mallets	376/35
1	Hammers for mechanics	382/300
1	Oilers	418/70
1	Crimping pliers for pre-insulated terminals	747
1	Professional tape rules with shockproof covering	981 A/3

kg	code	
7	U04960080	1



## 496 L <sup>mm</sup> Assortment for plumbers (25 pcs.)

- Supplied without plastic trays

pcs	description	item/size
1	Combination pliers	150 AX/180
1	Box-joint adjustable pliers	180 V/250
1	Hacksaw	201
1	Scissors for electricians	209
8	Set of 8 double ended open jaw wrenches /6x7-8x9-10x11-12x13-14x15-16x17-18x19-20x22	252 N/SR8
1	Adjustable wrenches with quick adjustment	294 AD/250
1	Swedish model pipe wrenches with thin, shaped jaws bent to 45°	310 N/340-1
1	Tube cutter for Copper and light alloy tubes	314 DA
4	Screwdrivers for slot-head screws / 0,5x3x75-0,8x4x100-1x5,5x125-1,2x8x200	324
2	Screwdrivers for PHILLIPS® screws / 1x75-2x100	324 PH
1	Hammers for mechanics	382/500
1	Carpenter's pencil	974 M
1	Wooden folding rule	980 M/2
1	Metal brush	993 A

kg	code	img
4,5	U04960090	1

## Are you looking for a solution to store your tools?



### Suitcases Pag. 27



### Bags Pag. 29



### Tool boxes - plastic Pag. 254



### Tool boxes - metal Pag. 255



### Cabinets, roller cabinets and workbenches Pag. 189



## 496 M <sup>mm</sup> Assortment for plumbers (51 pcs.)

- Supplied without plastic trays

pcs	description	item/size
1	Half-round extra-long nose pliers with straight jaws	133 AX/160
1	Lock-grip pliers with concave jaws	134/250
1	Combination pliers	150 AX/180
1	Box-joint adjustable pliers	180 V/250
1	Heavy-duty diagonal cutting nippers	188 AX/160
1	Hacksaw	200
1	Hacksaw	201
1	Shears for sheet steel	204/250
1	Scissors for electricians	209
13	Set of 13 double ended open jaw wrenches / 6x7-8x9-10x11-12x13-14x15-16x17-18x19-20x22-21x23-24x26-25x28-27x29-30x32	252 N/SR13
9	Set of 9 long angled hexagon keys	280 L/S9
1	Adjustable wrenches with quick adjustment	294 AD/250
1	American model pipe wrenches	302 N/350-2
1	Light-duty pipe wrenches with jaws bent to 90° /225-1 1/2"	308
1	Tube cutter for steel and stainless steel tubes	313 A
1	Tube cutter for Copper and light alloy tubes	314 DA
4	Screwdrivers for slot-head screws / 0,5x3x75-0,8x4x100-1x5,5x125-1,2x8x200	324
1	Screwdrivers for slot-head screws / 0,8x4x35	324 N
2	Screwdrivers for PHILLIPS® screws / 1x75-2x100	324 PH
1	Chisels for electricians	359/14x200
1	Mallets	376/35
1	Hammers for mechanics	382/500
1	Carpenter's pencil	974 M
1	Wooden folding rule	980 M/2
1	Flat square file	990 M PA/200
1	Square file	990 M PD/200
1	Metal brush	993 A

kg	code	img
15	U04960100	1

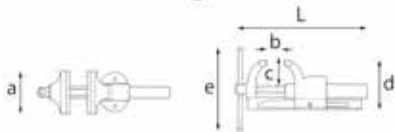

### 498 B

#### Parallel jaw vices for workbenches

- Fully forged steel model with jaws and body in one piece
- Rear jaw shaped like an anvil
- Ground prismatic double guide with screws for regulating the parallelism of the jaws and for recovering tightness of grip
- Supplied with pipe clamp jaws

axbxc mm	d mm	e mm	L mm	kg	code	
100x125x74	142	179	345	6,9	U04980012	1
125x150x83	156	198	380	10,7	U04980013	1
150x200x94	183	227	460	18	U04980014	1
175x235x123	216	256	532	25	U04980015	1



### 498 GB

#### Protective magnetic jaws

- Aluminium with rubber coating

L mm	kg	code	
100	180	U04980012Q	1
125	190	U04980013Q	1
150	200	U04980014Q	1



### 498 GC

#### Protective magnetic jaws

- Aluminium with fiber coating

L mm	kg	code	
100	87	U04980022Q	1
125	99	U04980023Q	1
150	102	U04980024Q	1



### 498 GA

#### Protective magnetic jaws

- Aluminium

L mm	kg	code	
100	180	U04980002Q	1
125	216	U04980003Q	1
150	252	U04980004Q	1



### 498 GD

#### Pipe clamp jaws

- Steel jaws for vice 498 B 100

LxPxH mm	kg	code	
41x32x32	320	U04980031Q	1



### 498 GE

#### Swivelling support

- For vice 498 B100
- Steel body
- To be used in combination with plans 5002 ZM2

LxPxH mm	kg	code	
165x165x22	1,5	U04980035Q	1

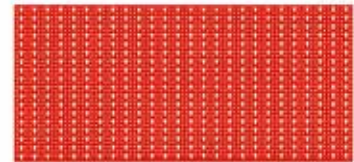

### 501 P

#### Perforated panels

- Hole diameter: 5 mm
- Steel sheet, thickness 1,2 mm
- Enamelled finish, colour red RAL 3020
- To be used with hooks 552÷559

size	LxPxH mm	kg	code	
A	1500x800x40	13,5	U05010104Q	1
B	2000x800x40	17,5	U05010105Q	1
C	1000x800x40	9,5	U05010103Q	1



### 504 S

#### Multi-purpose roller cabinet with 3 shelves

- Model with 3 shelves in high resistant ABS and rubber mats
- Shelves with edges to prevent objects from falling during transport
- Steel handle for optimal manoeuvrability
- Oil-proof rubber wheels (Ø 100 mm): two fixed and two swivelling, one of which has a brake
- Spare kit with 4 wheels: code 1004735-79
- Supplied disassembled
- Maximum loading capacity: 200 Kg

LxPxH mm	kg	code	
750x450x950	18	U05040003	1



## 506 BA

### Workbench with sheet steel top

- Galvanized sheet steel top (thickness 2 mm) with sides 37 mm
- Lower shelf included
- Arranged for ground fixing
- Enamelled sheet steel structure, black RAL 9004
- 4 brackets for size 1 m and 1,5 m
- 6 brackets for size 2 m
- Possibility to assemble one drawer 506 U130 for model 506 A2/1000 and 506 A2/1500
- Possibility to assemble two drawers 506 U130 for model 506 A2/2000
- Static load:
- L 1000= 1000 Kg
- L 1500= 1500 Kg
- L 2000= 2000 Kg



LxPxH mm	Kg	code	
1000x700x850	50	U05060014	1
1500x700x850	63	U05060015	1
2000x700x850	85	U05060016	1



## 506 BL

### Workbench with wooden top

- Multilayer wooden top (thickness 40 mm)
- Lower shelf included
- Arranged for ground fixing
- Enamelled sheet steel structure, black RAL 9004
- 4 brackets for size 1 m and 1,5 m
- 6 brackets for size 2 m
- Possibility to assemble one drawer 506 U130 for model 506 A1/1000 and 506 A1/1500
- Possibility to assemble two drawers 506 U130 for model 506 A1/2000
- Static load:
- L 1000= 1000 Kg
- L 1500= 1500 Kg
- L 2000= 2000 Kg



LxPxH mm	Kg	code	
1000x700x850	55	U05060004	1
1500x700x850	69	U05060005	1
2000x700x850	93	U05060006	1



## 506 BAC/2000

### Workbench with sheet steel top - 2 drawers

- Galvanized sheet steel top with 37 mm sides (thickness 2 mm)
- Lower shelf included
- Arranged for ground fixing
- Painted sheet steel casing
- 6 brackets
- 2 drawers on telescopic slides, with locking
- Structure: black RAL 9004, drawers red RAL 3020
- Inside dimensions of drawers: 570x420x175 mm
- Static load: 2000 kg



LxPxH mm	Kg	code	
2000x700x850	106	U05060034	1



## 506 BLC/2000

### Workbench with wooden top - 2 drawers

- Multilayer wooden top, 40 mm thickness
- Lower shelf included
- Arranged for ground fixing
- Painted sheet steel casing
- 6 brackets
- 2 drawers on telescopic slides, with locking
- Structure: black RAL 9004, drawers red RAL 3020
- Inside dimensions of drawers: 570x420x175 mm
- Static load: 2000 kg



LxPxH mm	Kg	code	
2000x700x850	109	U05060024	1

**3**  
MODULES

## 506 U130

### Drawer with slides for workbenches 506 B and 506 BL

- It can be used with workbenches 506 B and 506 BL
- Lock with keys included
- Inside dimensions: 570x420x175 mm
- Combinable with toolholding modules
- Red RAL 3020



Kg	code	
8	U05060129Q	1

# FURNITURE LINE START 516



A new modular range to easily create professional workstations.

## SIMPLE AND ESSENTIAL

10 components to set up your workstation the way you prefer.

Configurable in two heights: 842 mm and 1006 mm (worktop height from floor).

## QUALITY OF START RANGE

Design and materials of USAG START 516 roller cabinets range.

Components supplied assembled and ready for the lay-out.

## COMPATIBLE WITH USAG MODULARITY

The drawers are compatible with the USAG foam modules or plastic trays system present in the Catalog.



WOOD



### 516 SA/C1

Workshop furniture - wooden top

- Supplied with 30 hooks (kit 516 SA/K1)
- Complete range of hooks and supports at page 188

pcs	description	item/size
1	Cabinet with 6 drawers	516 SA/1
1	Cabinet with 2 doors	516 SA/2
6	Pegboard	516 SA/5
2	Raising support	516 SA/11
2	LED lamp	516 SA/12
2	Metal shelf for LED lamp	516 SA/13
2	Fitting kit	516 SA/14
1	Wooden top 1450 mm	516 SAL/1
1	Kit of 30 hooks for panels	516 SA/K1

LxPxH mm	kg	code	
1450x650x2000	127	U05160231	1



STEEL



### 516 SA/CA1

Workshop furniture - steel top

- Supplied with 30 hooks (kit 516 SA/K1)
- Complete range of hooks and supports at page 188

pcs	description	item/size
1	Cabinet with 6 drawers	516 SA/1
1	Cabinet with 2 doors	516 SA/2
6	Pegboard	516 SA/5
2	Raising support	516 SA/11
2	LED lamp	516 SA/12
2	Metal shelf for LED lamp	516 SA/13
2	Fitting kit	516 SA/14
1	Steel top 1450 mm	516 AC/1
1	Kit of 30 hooks for panels	516 SA/K1

LxPxH mm	kg	code	
1450x650x2000	135	U05160235	1





WOOD



## 516 SA/C2

### Workshop furniture - wooden top

- Supplied with 30 hooks (kit 516 SA/K1)
- Complete range of hooks and supports at page 188

pcs	description	item/size
1	Cabinet with 6 drawers	516 SA/1
1	Cabinet with 2 doors	516 SA/2
1	Cabinet with 1 door	516 SA/3
2	Top chest with tilting door	516 SA/4
3	Pegboard	516 SA/5
1	Pegboard with power strip	516 SA/6
3	Raising support	516 SA/11
2	LED lamp	516 SA/12
2	Fitting kit	516 SA/14
1	Wooden top 1450 mm	516 SAL/1
1	Kit of 30 hooks for panels	516 SA/K1

LxPxH mm	kg	code	
1950x650x2000	190	U05160232	1



WOOD



## 516 SA/C3

### Workshop furniture - wooden top

- Supplied with 30 hooks (kit 516 SA/K1)
- Complete range of hooks and supports at page 188

pcs	description	item/size
1	Cabinet with 6 drawers	516 SA/1
1	Cabinet with 2 doors	516 SA/2
1	Cabinet with 1 door	516 SA/3
3	Top chest with tilting door	516 SA/4
5	Pegboard	516 SA/5
1	Pegboard with power strip	516 SA/6
3	Raising support	516 SA/11
2	LED lamp	516 SA/12
3	Fitting kit	516 SA/14
1	START roller cabinet - 6 drawers (empty)	516 SA/16
1	Wooden top 2175 mm	516 SAL/2
1	Kit of 30 hooks for panels	516 SA/K1

LxPxH mm	kg	code	
2675x650x2000	278	U05160233	1



STEEL



## 516 SA/CA2

### Workshop furniture - steel top

- Supplied with 30 hooks (kit 516 SA/K1)
- Complete range of hooks and supports at page 188

pcs	description	item/size
1	Cabinet with 6 drawers	516 SA/1
1	Cabinet with 2 doors	516 SA/2
1	Cabinet with 1 door	516 SA/3
2	Top chest with tilting door	516 SA/4
3	Pegboard	516 SA/5
1	Pegboard with power strip	516 SA/6
3	Raising support	516 SA/11
2	LED lamp	516 SA/12
2	Fitting kit	516 SA/14
1	Steel top 1450 mm	516 AC/1
1	Kit of 30 hooks for panels	516 SA/K1

LxPxH mm	kg	code	
1950x650x2000	198	U05160236	1



STEEL



## 516 SA/CA3

### Workshop furniture - steel top

- Supplied with 30 hooks (kit 516 SA/K1)
- Complete range of hooks and supports at page 188

pcs	description	item/size
1	Cabinet with 6 drawers	516 SA/1
1	Cabinet with 2 doors	516 SA/2
1	Cabinet with 1 door	516 SA/3
3	Top chest with tilting door	516 SA/4
5	Pegboard	516 SA/5
1	Pegboard with power strip	516 SA/6
3	Raising support	516 SA/11
2	LED lamp	516 SA/12
3	Fitting kit	516 SA/14
1	START roller cabinet - 6 drawers (empty)	516 SA/16
1	Steel top 2175 mm	516 AC/2
1	Kit of 30 hooks for panels	516 SA/K1

LxPxH mm	kg	code	
2675x650x2000	289	U05160237	1



WOOD



### 516 SA/C4

#### Workshop furniture - wooden top

- Supplied with 30 hooks (kit 516 SA/K1)
- Complete range of hooks and supports at page 188

pcs	description	item/size
1	Cabinet with 6 drawers	516 SA/1
1	Cabinet with 2 doors	516 SA/2
8	Pegboard	516 SA/5
1	Pegboard with power strip	516 SA/6
2	Raising support	516 SA/11
2	LED lamp	516 SA/12
3	Metal shelf for LED lamp	516 SA/13
3	Fitting kit	516 SA/14
1	Wooden top 2175 mm	516 SAL/2
1	Kit of 30 hooks for panels	516 SA/K1

LxPxH mm	Kg	code	
2175x650x2000	147	U05160234	1



STEEL



### 516 SA/CA4

#### Workshop furniture - steel top

- Supplied with 30 hooks (kit 516 SA/K1)
- Complete range of hooks and supports at page 188

pcs	description	item/size
1	Cabinet with 6 drawers	516 SA/1
1	Cabinet with 2 doors	516 SA/2
8	Pegboard	516 SA/5
1	Pegboard with power strip	516 SA/6
2	Raising support	516 SA/11
2	LED lamp	516 SA/12
3	Metal shelf for LED lamp	516 SA/13
3	Fitting kit	516 SA/14
1	Steel top 2175 mm	516 AC/2
1	Kit of 30 hooks for panels	516 SA/K1

LxPxH mm	Kg	code	
2175x650x2000	160	U05160238	1



### 516 SA/1

#### Cabinet with 6 drawers

- Fully opening drawers on telescopic ball bearing slides
- Opportunity to store 3 modules in each drawer
- Drawer handles in high resistant ABS
- Possibility of mounting lateral accessories of 516 AC series (from 516 AC1 to 516 AC8)
- Oil-proof rubber mats inside
- Centralized locking system
- Supplied with bottle holder system that can be positioned on the right or left side - spare part SER.SBN1
- Sheet steel casing and drawers with epoxy process, colour black RAL 9004
- Drawers can be equipped with separators 519 SB
- Maximum loading capacity: 1,000 kg
- Possibility to use the raising support 516 SA/11, to increase height up to 1006 mm (including worktop)
- Possibility to use the adjustable feet 516 SA 15 when the floor is not perfectly level
- Drawer loading capacity: 20 kg for drawers h 60 mm, 25 kg for drawers h 130 mm and 30 kg for drawer h 200 mm
- Inside dimensions of the drawers:
  - 3 drawers 570x420x60 mm
  - 2 drawers 570x420x130 mm
  - 1 drawer 570x420x200 mm

LxPxH mm	Kg	code	
722x500x812	48	U05160201	1



### 516 SA/16

#### START roller cabinet - 6 drawers (empty)

- Ideal to be used in combination with the workshoP furniture line 516
- Worktop in high resistance ABS
- Double front carrying handle for greater maneuverability
- Fully opening drawers on telescopic ball bearing slides
- Opportunity to store 3 modules in each drawer
- Drawer handles in high resistance ABS
- Oil-proof rubber mats inside
- Centralized locking system
- 4 swivelling oil-proof rubber wheels (Ø 125 mm), two with brakes
- Sheet steel casing and drawers with epoxy process, colour black RAL 9004
- Maximum loading capacity: 800 kg
- Max drawer loading capacity: 40 kg
- Inside dimensions of the drawers:
  - 3 drawers 570x420x60 mm
  - 2 drawers 570x420x130 mm
  - 1 drawer 570x420x200 mm

LxPxH mm	Kg	code	
722x550x970	60	U05160216	1



### 516 SA/2

#### Cabinet with 2 doors

- 1 internal shelf adjustable in height (70 mm step), resistant to a load of 50 kg
- Centralized locking system
- Sheet steel casing with epoxy process, colour black RAL 9004
- Possibility of mounting lateral accessories such as waste holder 519 RA1, bottle holder 519 RA5, document holder 519 RA2, roll holder 519 RA4
- Possibility of adding other RWS-MBSPP.04BS shelves
- Possibility to use the raising support 516 SA/11, to increase height up to 1006 mm (including worktop)
- Possibility to use the adjustable feet 516 SA 15 when the floor is not perfectly level

LxPxH mm	kg	code	
722x500x812	30,5	U05160202	1

The **online configurator** helps you to create **your customized professional workstation** in a **simple way**.



[start516-gb.usag.it](http://start516-gb.usag.it)



### 516 SA/3

#### Cabinet with 1 door

- Door handle in high resistance ABS
- 3 internal shelves adjustable in height (70 mm step), resistant to a load of 50 kg
- 1 clothes hanging bar attached under a shelf
- Key lock
- Sheet steel casing with epoxy process, colour black RAL 9004
- Possibility to use the raising support 516 SA/11, to increase height up to 2000 mm (including worktop)
- Possibility to use the adjustable feet 516 SA 15 when the floor is not perfectly level

LxPxH mm	kg	code	
500x500x1835	44,5	U05160203	1



### 516 SA/4

#### Top chest with tilting door

- Overhead door with two jacks
- Door handle in high resistance ABS
- Maximum loading capacity: 30 kg
- Key lock
- Sheet steel casing with epoxy process, colour black RAL 9004
- Easy and quick to fasten with the fitting kit 516 SA/14

LxPxH mm	kg	code	
720x280x355	10,2	U05160204	1

900 KG

PAGE  
**196**



## **RACING 519**

### **TOP CHOICE**

#### **Tilting aluminium handles**

- Drawers with anodized Aluminium handles and hooking system
- Rubber bumper profiles on the uprights and drawers
- Work top in non-scratch aluminium

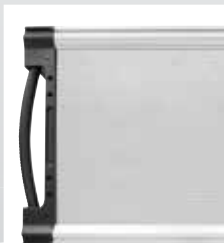

YouTube

800 KG

PAGE  
**189**



## **START 516**

### **QUALITY AND CONVENIENCE**

#### **Tilting ABS handles**

- Worktop in high resistant ABS with edges that prevent objects from falling
- Drawers with high resistance ABS handles



YouTube

## 519 RACING

ROLLER CABINETS			
5 drawers	6 drawers	7 drawers	8 drawers

DRAWER CHESTS
4 drawers

MOBILE WORKBENCHS

## 516 START

5 drawers	6 drawers	7 drawers	8 drawers

4 drawers

workbenchs 6 drawers

### WORKSHOP FURNITURE RANGE





## 516 SAL

### Wooden top

- In multilayer beech, 30 mm thick
- Maximum loading capacity: 1000 kg

n°	LxPxH mm	kg	code	
1	1450x600x30	18,5	U05160207	1
2	2175x600x30	29	U05160208	1



## 516 AC

### Steel top

- Galvanized top
- Maximum loading capacity: 1000 kg
- Thickness: 30 mm

n°	LxPxH mm	kg	code	
1	1450x600x30	27	U05160209	1
2	2175x600x30	40	U05160210	1



## 516 SA/5

### Pegboard

- 6x6 mm square drilling, with 12 mm pitch
- Positioning of tools by means of hooks and CKS supports
- Sheet steel casing with epoxy process, colour black RAL 9004, 1.2 mm thick
- Easy and quick to fasten with the fitting kit 516 SA/14

LxPxH mm	kg	code	
720x40x335	2	U05160205	1



## 516 SA/6

### Pegboard with power strip

- Supplied with a group of 6 SCHUKO sockets with luminous switch
- 6x6 mm square drilling, with 12 mm pitch
- Positioning of tools by means of hooks and CKS supports
- Sheet steel casing with epoxy process, colour black RAL 9004, 1.2 mm thick
- Easy and quick to fasten with the fitting kit 516 SA/14

LxPxH mm	kg	code	
720x40x335	2,5	U05160206	1



## 516 SA/K1

### Kit of hooks for panels

- Assortment of 30 hooks for 516 SA/5 and 516 SA/6 panels
- 20 high strength ABS straight hooks and 10 metal hooks for wrenches
- Contents:  
20 straight hooks  
5 hooks for small flat wrenches  
5 hooks for large flat wrenches

code	
U05160230	1



## 516 SA/K2

### Tool hook for combination wrenches

Ø mm	code	
15	U05160270	10
30	U05160271	10



## 516 SA/K3

### Tool hooks for cylindrical tools

Ø mm	code	
8÷12	U05160272	5
12÷15	U05160273	5
15÷25	U05160274	5
25÷32	U05160275	5



## 516 SA/K4

### Drift punch rack

LxPxH mm	code	
170x35x70	U05160276	1



## 516 SA/K5

### Screwdriver rack

LxPxH mm	code	
238x38x50	U05160277	1



## 516 SA/K6

### Wrench rack

n°	size	code	
8	6÷14	U05160278	1
8	14÷27	U05160279	1
4	24÷42	U05160280	1



## 516 SA/K7

### File rack

n°	code	
9	U05160281	1
5	U05160282	1



## 516 SA/11

### Raising support

- Can be used with cabinet 516 SA/1, 516 SA/2 and 516 SA/3
- Possibility to use the adjustable feet 516 SA 15 when the floor is not perfectly level

kg	code	
3,6	U05160211	1



## 516 SA/12

### LED lamp

- Brightness: 750 Lumen
- Applicable on the shelf 516 SA/13 or on the top chest with tilting door 516 SA/4

L mm	code	
570	U05160212	1



## 516 SA/13

### Metal shelf for LED lamp

- Can be used as a holder for LED lamp
- Drilling for screwdriver housing

LxPxH mm	kg	code	
722x164x70	1,2	U05160213	1



## 516 SA/14

### Fitting kit

- Consisting of two metal C-bars with epoxy paint
- It is used for the assembly of top chests and pegboards on the worktop

kg	code	
2,8	U05160214	1



## 516 SA/15

### 4 Adjustable feet

To be used with cabinets 516 SA/1, 516 SA/2, 516 SA/3 or raising support 516 SA/11

code	
U05160215	1

**3**  
MODULES



### 516 STC4V

#### START drawer chest - 4 drawers (empty)

- Can be mounted on the worktop of every START 516 ST roller cabinet
- Work top in high resistant ABS with built-in 15 mm edges to prevent objects from falling during transport
- Double transport handle for better manoeuvrability
- Fully opening drawers on telescopic ball bearing slides
- Opportunity to store 3 modules in each drawer
- Drawer handles in high resistant ABS
- Oil-proof rubber mats inside
- Centralized locking system
- Supplied with bottle holder system that can be placed on the side - spare code SER.SBN1
- Sheet steel casing and drawers with epoxy process, colour red RAL 3020
- Drawer loading capacity: 40 kg
- Inside dimensions:  
3 drawers 570x420x60 mm  
1 drawers 570x420x130 mm

LxPxH mm	kg	code	
779x515x467	34	U05160104	1

**3**  
MODULES



### 516 ST5V

#### START roller cabinet - 5 drawers (empty)

- Work top in high resistant ABS with built-in 15 mm edges to prevent objects from falling during transport
- Double transport handle for better manoeuvrability
- Fully opening drawers on telescopic ball bearing slides
- Opportunity to store 3 modules in each drawer
- Drawer handles in high resistant ABS
- Oil-proof rubber mats inside
- Centralized locking system
- Supplied with bottle holder system that can be placed on the side - spare code SER.SBN1
- Oil-proof rubber wheels (Ø 125 mm): two fixed and two swivelling, one of which has a brake
- Sheet steel casing and drawers with epoxy process, colour red RAL 3020
- Maximum loading capacity: 800 Kg
- Delivered with wheels already assembled to the structure
- Drawer loading capacity: 40 kg
- Inside dimensions:  
2 drawers 570x420x60 mm  
2 drawers 570x420x130 mm  
1 drawer 570x420x270 mm

LxPxH mm	kg	code	
779x515x972	54	U05160105	1

### 516 ST5HYA-S

#### START roller cabinet with assortment for safety and maintenance of battery cells 495 098 HYB (20 pcs.)

kg	code	
58	U05168024	1



### 516 ST5HYB-S

#### START roller cabinet with assortment for safety and maintenance of hybrid and electric cars 495 098HYB133(133 pcs.)

kg	code	
52	U05168025	1



**3**  
MODULES



### 516 ST6V

#### START roller cabinet - 6 drawers (empty)

- Work top in high resistant ABS with built-in 15 mm edges to prevent objects from falling during transport
- Double transport handle for better manoeuvrability
- Fully opening drawers on telescopic ball bearing slides
- Opportunity to store 3 modules in each drawer
- Drawer handles in high resistant ABS
- Oil-proof rubber mats inside
- Centralized locking system
- Supplied with bottle holder system that can be placed on the side - spare code SER.SBN1
- Oil-proof rubber wheels (Ø 125 mm): two fixed and two swivelling, one of which has a brake
- Sheet steel casing and drawers with epoxy process, colour red RAL 3020
- Maximum loading capacity: 800 Kg
- Delivered with wheels already assembled to the structure
- Drawer loading capacity: 40 kg
- Inside dimensions:  
3 drawers 570x420x60 mm  
2 drawers 570x420x130 mm  
1 drawer 570x420x270 mm

LxPxH mm	kg	code	
779x515x972	55	U05160106	1

### 516 ST6MA

#### START roller cabinet with AUTOMOTIVE assortment 495 MAA (155 pcs.)

kg	code	
70	U05160627	1



### 516 ST6MM

#### START XL roller cabinet with assortment for MAINTENANCE 495 MB (156 pcs.)

kg	code	
71	U05160628	1



### 516 ST6PA

#### START roller cabinet with AUTOMOTIVE assortment 495 PA (142 pcs.)

kg	code	
67	U05160629	1



### 516 ST6PM

#### START roller cabinet with AUTOMOTIVE assortment 495 PM (154 pcs.)

kg	code	
69	U05160630	1





**3**  
MODULES



### 516 ST6NV

#### START roller cabinet - 6 drawers (empty)

- Work top in high resistant ABS with built-in 15 mm edges to prevent objects from falling during transport
- Double transport handle for better manoeuvrability
- Fully opening drawers on telescopic ball bearing slides
- Opportunity to store 3 modules in each drawer
- Drawer handles in high resistant ABS
- Oil-proof rubber mats inside
- Centralized locking system
- Supplied with bottle holder system that can be placed on the side - spare code SER.SBN1
- Oil-proof rubber wheels (Ø 125 mm): two fixed and two swivelling, one of which has a brake
- Sheet steel casing and drawers with epoxy process, colour black RAL 9005
- Maximum loading capacity: 800 Kg
- Delivered with wheels already assembled to the structure
- Drawer loading capacity: 40 kg
- Inside dimensions:  
3 drawers 570x420x60 mm  
2 drawers 570x420x130 mm  
1 drawer 570x420x200 mm

LxPxH mm	Kg	code	
779x515x972	55	U05160116	1



### 516 ST6NMA

#### START roller cabinet with AUTOMOTIVE assortment 495 MAA (155 pcs.)



Kg	code	
70	U05161627	1



### 516 ST6NMM

#### START roller cabinet with assortment for MAINTENANCE 495 MB (156 pcs.)



Kg	code	
71	U05161628	1



### 516 ST6NPA

#### START roller cabinet with AUTOMOTIVE assortment 495 PA (142 pcs.)



Kg	code	
67	U05161629	1



### 516 ST6NPM

#### START roller cabinet with assortment for MAINTENANCE 495 PM (154 pcs.)



Kg	code	
69	U05161630	1



**3**  
MODULES



### 516 STS6NV

#### START roller cabinet with Safety Lock System - 6 drawers (empty)

- Safety Lock System that allows to open only one drawer in the same time
- Work top in high resistant ABS with built-in 15 mm edges to prevent objects from falling during transport
- Double transport handle for better manoeuvrability
- Fully opening drawers on telescopic ball bearing slides
- Opportunity to store 3 modules in each drawer
- Drawer handles in high resistant ABS
- Oil-proof rubber mats inside
- Centralized locking system
- Supplied with bottle holder system that can be placed on the side - spare code SER.SBN1
- Oil-proof rubber wheels (Ø 125 mm): two fixed and two swivelling, one of which has a brake
- Sheet steel casing and drawers with epoxy process, colour black 9005
- Maximum loading capacity: 800 Kg
- Delivered with wheels already assembled to the structure
- Drawer loading capacity: 40 kg
- Inside dimensions:  
3 drawers 570x420x60 mm  
1 drawers 570x420x130 mm  
1 drawer 570x420x200 mm

LxPxH mm	Kg	code	
779x515x972	56	U05160136	1



**3**  
MODULES



### 516 ST7V

#### START roller cabinet - 7 drawers (empty)

- Work top in high resistant ABS with built-in 15 mm edges to prevent objects from falling during transport
- Double transport handle for better manoeuvrability
- Fully opening drawers on telescopic ball bearing slides
- Opportunity to store 3 modules in each drawer
- Drawer handles in high resistant ABS
- Oil-proof rubber mats inside
- Centralized locking system
- Supplied with bottle holder system that can be placed on the side - spare code SER.SBN1
- Oil-proof rubber wheels (Ø 125 mm): two fixed and two swivelling, one of which has a brake
- Sheet steel casing and drawers with epoxy process, colour red RAL 3020
- Maximum loading capacity: 800 Kg
- Delivered with wheels already assembled to the structure
- Drawer loading capacity: 40 kg
- Inside dimensions:  
5 drawers 570x420x60 mm  
1 drawers 570x420x130 mm  
1 drawer 570x420x200 mm

LxPxH mm	Kg	code	
779x515x972	56	U05160107	1





**3**  
MODULES



### 516 ST7NV

#### START roller cabinet - 7 drawers (empty)

- Work top in high resistant ABS with built-in 15 mm edges to prevent objects from falling during transport
- Double transport handle for better manoeuvrability
- Fully opening drawers on telescopic ball bearing slides
- Opportunity to store 3 modules in each drawer
- Drawer handles in high resistant ABS
- Oil-proof rubber mats inside
- Centralized locking system
- Supplied with bottle holder system that can be placed on the side - spare code SER.SBN1
- Oil-proof rubber wheels (Ø 125 mm): two fixed and two swivelling, one of which has a brake
- Sheet steel casing and drawers with epoxy process, colour nero RAL 9005
- Maximum loading capacity: 800 Kg
- Delivered with wheels already assembled to the structure
- Drawer loading capacity: 40 kg
- Inside dimensions:  
5 drawers 570x420x60 mm  
1 drawers 570x420x130 mm  
1 drawer 570x420x200 mm

LxPxH mm	kg	code	
779x515x972	56	U05160117	1



**4**  
MODULES



### 516 STXL6V

#### START XL roller cabinet - 6 drawers (empty)

- Work top in high resistant ABS with built-in 15 mm edges to prevent objects from falling during transport
- Double transport handle for better manoeuvrability
- Fully opening drawers on telescopic ball bearing slides
- Opportunity to store 4 modules in each drawer
- Drawer handles in high resistant ABS
- Oil-proof rubber mats inside
- Centralized locking system
- Supplied with bottle holder system that can be placed on the side - spare code SER.SBN1
- Oil-proof rubber wheels (Ø 125 mm): two fixed and two swivelling, one of which has a brake
- Sheet steel casing and drawers with epoxy process, colour red RAL 3020
- Maximum loading capacity: 800 Kg
- Delivered with wheels already assembled to the structure
- Drawer loading capacity: 40 kg
- Inside dimensions:  
3 drawers 570x420x60 mm  
2 drawers 570x420x130 mm  
1 drawer 570x420x200 mm

LxPxH mm	kg	code	
969x515x972	68	U05160146	1



### 516 STXL6MM

#### START XL roller cabinet with assortment for MAINTENANCE 495 MC (300 pcs.)

kg	code	
96	U05160632	1



**4**  
MODULES



### 516 STXL6NV

#### START XL roller cabinet - 6 drawers (empty)

- Work top in high resistant ABS with built-in 15 mm edges to prevent objects from falling during transport
- Double transport handle for better manoeuvrability
- Fully opening drawers on telescopic ball bearing slides
- Opportunity to store 4 modules in each drawer
- Drawer handles in high resistant ABS
- Oil-proof rubber mats inside
- Centralized locking system
- Supplied with bottle holder system that can be placed on the side - spare code SER.SBN1
- Oil-proof rubber wheels (Ø 125 mm): two fixed and two swivelling, one of which has a brake
- Sheet steel casing and drawers with epoxy process, colour nero RAL 9005
- Maximum loading capacity: 800 Kg
- Delivered with wheels already assembled to the structure
- Drawer loading capacity: 40 kg
- Inside dimensions:  
3 drawers 760x420x60 mm  
2 drawers 760x420x130 mm  
1 drawer 760x420x200 mm

LxPxH mm	kg	code	
969x515x972	68	U05160156	1



### 516 STXL6MMM

#### START XL roller cabinet with assortment for MAINTENANCE 495 MC (300 pcs.)

kg	code	
96	U05161632	1





NEW

3  
MODULES



### 516 ST8V

#### START roller cabinet - 8 drawers (empty)

- Work top in high resistant ABS with built-in 15 mm edges to prevent objects from falling during transport
- Double transport handle for better manoeuvrability
- Fully opening drawers on telescopic ball bearing slides
- Opportunity to store 3 modules in each drawer
- Drawer handles in high resistant ABS
- Oil-proof rubber mats inside
- Centralized locking system
- Supplied with bottle holder system that can be placed on the side - spare code SER.SBN1
- Oil-proof rubber wheels (Ø 125 mm): two fixed and two swivelling, one of which has a brake
- Sheet steel casing and drawers with epoxy process, colour red RAL 3020
- Maximum loading capacity: 800 Kg
- Delivered with wheels already assembled to the structure
- Drawer loading capacity: 40 kg
- Inside dimensions:
- 6 drawers 570x420x60 mm
- 1 drawers 570x420x130 mm
- 1 drawer 570x420x200 mm

LxPxH mm	Kg	code	
779x515x972	58	U05160108	1



3  
MODULES



### 516 SU2V

#### START utility chart - 2 drawers (empty)

- Work top in high resistant ABS with built-in 15 mm edges to prevent objects from falling during transport
- Double transport handle for better manoeuvrability
- Fully opening drawers on telescopic ball bearing slides
- Opportunity to store 3 modules in each drawer
- Drawer handles in high resistant ABS
- Oil-proof rubber mats inside
- Centralized locking system
- Shelves with edges to prevent objects from falling during transport and plastic cover
- Oil-proof rubber wheels (Ø 125 mm): two fixed and two swivelling, one of which has a brake
- Sheet steel casing and drawers with epoxy process, colour red RAL 3020
- Maximum loading capacity: 200 Kg
- Delivered dismounted
- Drawer loading capacity: 40 kg
- Inside dimensions: 2 drawers 570x420x60 mm

LxPxH mm	Kg	code	
779x515x972	30	U05160002	1

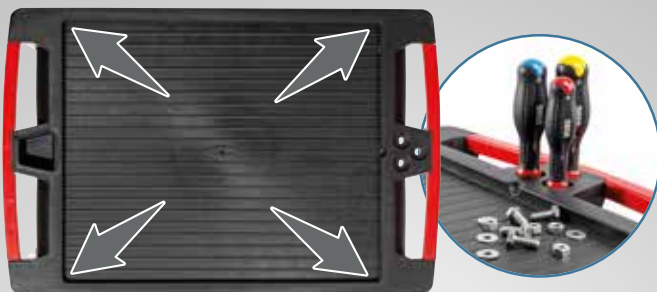

WORK TOP WITH DIMENSIONS 460 X 560 MM  
IN WITH BUILT-IN 15 MM EDGES

# START 516



YouTube

DRAWER HANDLES IN HIGH RESISTANT ABS



### 516 SUXL

#### START XL utility chart

- Work top in high resistant ABS with built-in 15 mm edges to prevent objects from falling during transport
- Double transport handle for better manoeuvrability
- Shelves with edges to prevent objects from falling during transport and plastic cover
- Oil-proof rubber wheels (Ø 125 mm): two fixed and two swivelling, one of which has a brake
- Sheet steel casing and drawers with epoxy process, colour red RAL 3020
- Maximum loading capacity: 300 Kg
- Delivered dismounted

LxPxH mm	Kg	code	
969x515x972	22	U05160003	1

3  
MODULES



### 516 SPC1

#### START workbench with wooden top - 6 drawers (empty)

- Worktop in multilayer beech wood (thickness 40 mm)
- 1 side bracket and 1 drawer chest with 6 drawers
- Fully opening drawers on telescopic ball bearing slides
- Opportunity to store 3 modules in each drawer
- Drawer handles in high resistant ABS
- Oil-proof rubber mats inside
- Centralized locking system
- Supplied with bottle holder system that can be placed on the side - spare code SER. SBR2
- Sheet steel casing and drawers with epoxy process, colour red RAL 3020
- Maximum loading capacity: 1.000 Kg
- Drawer loading capacity: 20 kg for drawers h 60 mm; 25 Kg for drawers h 130 mm and Kg 30 for drawer h 200 mm)
- Inside dimensions:  
3 drawers 570x420x60 mm  
2 drawers 570x420x130 mm  
1 drawer 570x420x200 mm

LxPxH mm	kg	code	
2000x700x850	115	U05160020	1

3  
MODULES



### 516 SPCN1

#### START workbench with wooden top - 6 drawers (empty)

- Worktop in multilayer beech wood (thickness 40 mm)
- 1 side bracket and 1 drawer chest with 6 drawers
- Fully opening drawers on telescopic ball bearing slides
- Opportunity to store 3 modules in each drawer
- Drawer handles in high resistant ABS
- Oil-proof rubber mats inside
- Centralized locking system
- Supplied with bottle holder system that can be placed on the side - spare code SER. SBN1
- Sheet steel casing and drawers with epoxy process, colour black RAL 9004
- Maximum loading capacity: 1.000 Kg
- Drawer loading capacity: 20 kg for drawers h 60 mm; 25 Kg for drawers h 130 mm and Kg 30 for drawer h 200 mm)
- Inside dimensions:  
3 drawers 570x420x60 mm  
2 drawers 570x420x130 mm  
1 drawer 570x420x200 mm

LxPxH mm	kg	code	
2000x700x854	115	U05160022	1

3  
MODULES



### 516 SPC2

#### START workbench with sheet steel top - 6 drawers (empty)

- Galvanized sheet steel top with 37 mm sides (thickness 2,5 mm)
- 1 side bracket and 1 drawer chest with 6 drawers
- Fully opening drawers on telescopic ball bearing slides
- Opportunity to store 3 modules in each drawer
- Drawer handles in high resistant ABS
- Oil-proof rubber mats inside
- Centralized locking system
- Supplied with bottle holder system that can be placed on the side - spare code SER. SBR2
- Sheet steel casing and drawers with epoxy process, colour red RAL 3020
- Maximum loading capacity: 1.000 Kg
- Drawer loading capacity: 20 kg for drawers h 60 mm; 25 Kg for drawers h 130 mm and Kg 30 for drawer h 200 mm)
- Inside dimensions:  
3 drawers 570x420x60 mm  
2 drawers 570x420x130 mm  
1 drawer 570x420x200 mm

LxPxH mm	kg	code	
2000x700x850	102	U05160021	1

3  
MODULES



### 516 SPCN2

#### START workbench with sheet steel top - 6 drawers (empty)

- Galvanized sheet steel top with 37 mm sides (thickness 2,5 mm)
- 1 side bracket and 1 drawer chest with 6 drawers
- Fully opening drawers on telescopic ball bearing slides
- Opportunity to store 3 modules in each drawer
- Drawer handles in high resistant ABS
- Oil-proof rubber mats inside
- Centralized locking system
- Supplied with bottle holder system that can be placed on the side - spare code SER. SBN1
- Sheet steel casing and drawers with epoxy process, colour black RAL 9004
- Maximum loading capacity: 1.000 Kg
- Drawer loading capacity: 20 kg for drawers h 60 mm; 25 Kg for drawers h 130 mm and Kg 30 for drawer h 200 mm)
- Inside dimensions:  
3 drawers 570x420x60 mm  
2 drawers 570x420x130 mm  
1 drawer 570x420x200 mm

LxPxH mm	kg	code	
2000x700x850	102	U05160023	1



### 516 AC1

#### Paper roll holder

- Lateral accessory for START 516 and RACING 519 roller cabinets
- Suitable also with workshop system START 516
- RAL 9005 painted steel

▲ gr	code	
800	U05160301	1



### 516 AC2

#### Bottle holder

- Lateral accessory for START 516 and RACING 519 roller cabinets
- Suitable also with workshop system START 516
- Internal plastic cover
- RAL 9005 painted steel

LxPxH mm	▲ Kg	code	
380x110x120	1,5	U05160302	1



### 516 AC3

#### Document holder

- Lateral accessory for START 516 and RACING 519 roller cabinets
- Suitable also with workshop system START 516
- RAL 9005 painted steel

LxPxH mm	▲ Kg	code	
55x380x315	1,2	U05160303	1



### 516 AC4

#### Waste holder

- Lateral accessory for START 516 and RACING 519 roller cabinets
- Suitable also with workshop system START 516
- RAL 9005 painted steel

LxPxH mm	▲ Kg	code	
200x380x340	3,2	U05160304	1



### 516 AC5

#### Side cabinet with lock

- Lateral accessory for START 516 and RACING 519 roller cabinets
- Suitable also with workshop system START 516
- Perforated panel to be used with tools hooks
- RAL 9005 painted steel

LxPxH mm	▲ Kg	code	
60x380x750	8,3	U05160305	1



### 516 AC6

#### Foldable shelf

- Lateral accessory for START 516 and RACING 519 roller cabinets
- Suitable also with workshop system START 516
- Plastic cover on the shelf against oil and chemicals
- RAL 9005 painted steel

LxPxH mm	▲ Kg	code	
500x380x20	5,5	U05160306	1



### 516 AC7

#### Power tools holder

- Lateral accessory for START 516 and RACING 519 roller cabinets
- Suitable also with workshop system START 516
- Can fit up to 3 different power tools
- Internal rubber protection on each hole
- RAL 9005 painted steel

LxPxH mm	▲ Kg	code	
200x380x340	2,3	U05160307	1



### 516 AC8

#### Side power connection

- Lateral accessory for START 516 and RACING 519 roller cabinets
- Suitable also with workshop system START 516
- Bottle holder integrated
- Multiple electric Schuko sockets with USB
- RAL 9005 painted steel

LxPxH mm	▲ Kg	code	
55x380x450	3,5	U05160308	1



### 516 AC9

#### Wooden top

- Accessory dedicated only for the worktop of START 516 ST roller cabinets
- 15 mm thickness
- Multilayer wood

LxPxH mm	▲ Kg	code	
560x460x15	4,3	U05160309	1



### 516 AC10

#### Transportation kit for START chest

- Accessory dedicated only for the drawers chest START 516 STC4V
- Includes:
  - Metal handle
  - Wheels (Ø 125 mm): two fixed and two swivelling, one of which has a brake

▲ Kg	code	
5,9	U05160310	1



NEW

## 519 RSAV

### Empty tool cabinet - 2 drawers

- Internal perforated panels
- Doors opening at 180°
- Fully opened drawers
- Telescopic ball-bearing slides
- Drawers with anodized Aluminium handle
- Centralized locking system
- Can be hanged on the wall
- Sheet steel casing with epoxy process, colour black RAL 9004
- Doors painted red RAL 3020
- Hooks and supports not supplied
- Inside dimensions of the drawers: 569x210x60 mm

LxPxH mm	kg	code	
720x280x1000	45	U05190400	1



NEW

## 519 RSANV

### Empty tool cabinet - 2 drawers

- Internal perforated panels
- Doors opening at 180°
- Fully opened drawers
- Telescopic ball-bearing slides
- Drawers with anodized Aluminium handle
- Centralized locking system
- Can be hanged on the wall
- Sheet steel casing with epoxy process, colour black RAL 9004
- Hooks and supports not supplied
- Inside dimensions of the drawers: 569x210x60 mm

LxPxH mm	kg	code	
720x280x1000	45	U05190401	1



## 502 KA1

### Kit with hooks and supports for cabinet 502 R1V (52 pcs.)

- Assortment with sheet steel supports for wrenches, screwdrivers, pliers, sockets
- Supplied with 56 screws for hooks

pcs	description	item/size
1	Empty holders for pliers, cutting nippers and miscellaneous tools	157 RV/14
1	Empty plastic display stand	252 ASV13
1	Empty holder for combination wrenches	285 RV17
1	Empty holders for screwdrivers	323 RV/10
40	Bent adjustable hooks	552 V/40
6	Spring hooks	557 V/2-3
1	Plastic stands for sockets	559/1/2
1	Metal holders	559 B/170

kg	code	
2,8	U05020020Q	1



## 502 KA2

### Kit with hooks and supports for cabinet 502 R2V (106 pcs.)

- Assortment with sheet steel supports for wrenches, screwdrivers, pliers, sockets
- Supplied with 99 screws for hooks

pcs	description	item/size
2	Empty holders for pliers, cutting nippers and miscellaneous tools	157 RV
1	Empty plastic display stand	252 ASV13
1	Empty holder for combination wrenches	285 RV17
1	Empty holders for screwdrivers	323 RV
60	Bent adjustable hooks	552 V/40
20	Spring hooks	557 V/3
5	Spring hooks	557 V/2
14	Plastic stands for sockets	559/1/2
2	Metal holders	559 B/250

kg	code	
3,6	U05020021Q	1



**3**

MODULES

### 519 RSC4/3V

#### RACING drawer chest - 4 drawers (empty)

- Can be mounted on the worktop of every RACING 519 RS roller cabinet (3 modules)
- Work top in non-scratch Aluminium (2 mm)
- 15 mm wooden layer integrated under the worktop
- Soft touch double handle integrated in the worktop
- Innovative rail system integrated in the worktop to fit accessories (519 ACT range)
- Shock resistant profiles on sides and drawers
- Fully opening drawers on telescopic ball-bearing slides
- Drawers slide with soft closing system
- Opportunity to store 3 modules in each drawer
- Drawers with anodized Aluminium handles
- Quick drawer opening system
- Oil-proof rubber mats inside
- Centralized locking system
- Side panels arranged for mounting optional accessories (516 AC)
- Sheet steel casing and drawers with epoxy process, colour red RAL 3020
- Drawer loading capacity: 40 Kg
- Inside dimensions:  
3 drawers 570x420x60 mm  
1 drawer 570x420x130 mm

LxPxH mm	kg	code	
814x575x500	45	U05190534	1



**5**

MODULES

### 519 RSC4/5V

#### RACING drawer chest - 4 drawers (empty)

- Can be mounted on the worktop of every RACING 519 RS roller cabinet (5 modules)
- Work top in non-scratch Aluminium (2 mm)
- 15 mm wooden layer integrated under the worktop
- Soft touch double handle integrated in the worktop
- Innovative rail system integrated in the worktop to fit accessories (519 ACT range)
- Shock resistant profiles on sides and drawers
- Fully opening drawers on telescopic ball-bearing slides
- Drawers slide with soft closing system
- Opportunity to store 5 modules in each drawer
- Drawers with anodized Aluminium handles
- Quick drawer opening system
- Oil-proof rubber mats inside
- Centralized locking system
- Side panels arranged for mounting optional accessories (516 AC)
- Sheet steel casing and drawers with epoxy process, colour red RAL 3020
- Drawer loading capacity: 45 Kg
- Inside dimensions:  
3 drawers 950x420x60 mm  
1 drawer 950x420x130 mm

LxPxH mm	kg	code	
1194x575x500	60	U05190554	1



**4**

MODULES

### 519 RSC4/4V

#### RACING drawer chest - 4 drawers (empty)

- Can be mounted on the worktop of every RACING 519 RS roller cabinet (4 modules)
- Work top in non-scratch Aluminium (2 mm)
- 15 mm wooden layer integrated under the worktop
- Soft touch double handle integrated in the worktop
- Innovative rail system integrated in the worktop to fit accessories (519 ACT range)
- Shock resistant profiles on sides and drawers
- Fully opening drawers on telescopic ball-bearing slides
- Drawers slide with soft closing system
- Opportunity to store 4 modules in each drawer
- Drawers with anodized Aluminium handles
- Quick drawer opening system
- Oil-proof rubber mats inside
- Centralized locking system
- Side panels arranged for mounting optional accessories (516 AC)
- Sheet steel casing and drawers with epoxy process, colour red RAL 3020
- Drawer loading capacity: 45 Kg
- Inside dimensions:  
3 drawers 760x420x60 mm  
1 drawer 760x420x130 mm

LxPxH mm	kg	code	
1004x575x500	51	U05190544	1



**3**

MODULES



### 519 RS6/3V

#### RACING roller cabinet - 6 drawers (empty)

- Work top in non-scratch Aluminium (2 mm)
- 15 mm wooden layer integrated under the worktop
- Soft touch double handle integrated in the worktop
- Innovative rail system integrated in the worktop to fit accessories (519 ACT range)
- Shock resistant profiles on sides and drawers
- Fully opening drawers on telescopic ball-bearing slides
- Drawers slide with soft closing system
- Opportunity to store 3 modules in each drawer
- Drawers with anodized Aluminium handles
- Quick drawer opening system
- Oil-proof rubber mats inside
- Centralized locking system
- Side panels arranged for mounting optional accessories (516 AC)
- Oil-proof rubber wheels (Ø 125 mm): two fixed and two swivelling (both with brake)
- Sheet steel casing and drawers with epoxy process, colour red RAL 3020
- Maximum loading capacity: 900 Kg
- Drawer loading capacity: 40 Kg
- Inside dimensions:  
4 drawers 570x420x60 mm  
1 drawer 570x420x130 mm  
1 drawer 570x420x270 mm

LxPxH mm	kg	code	
814x575x1005	75	U05190506	1



### 519 RS6/3MA

RACING roller cabinet with AUTOMOTIVE assortment 495 MAA (155 pcs.)

kg	code	1
90	U05190627	1



### 519 RS6/3MM

RACING roller cabinet with assortment for MAINTENANCE 495 MB (156 pcs.)

kg	code	1
91	U05190628	1



3  
MODULES



### 519 RS6/3NV

RACING roller cabinet - 6 drawers (empty)

- Work top in non-scratch Aluminium (2 mm)
- 15 mm wooden layer integrated under the worktop
- Soft touch double handle integrated in the worktop
- Innovative rail system integrated in the worktop to fit accessories (519 ACT range)
- Shock resistant profiles on sides and drawers
- Fully opening drawers on telescopic ball-bearing slides
- Drawers slide with soft closing system
- Opportunity to store 3 modules in each drawer
- Drawers with anodized Aluminium handles
- Quick drawer opening system
- Oil-proof rubber mats inside
- Centralized locking system
- Side panels arranged for mounting optional accessories (516 AC)
- Oil-proof rubber wheels (Ø 125 mm): two fixed and two swivelling (both with brake)
- Sheet steel casing and drawers with epoxy process, colour black RAL 9005
- Maximum loading capacity: 900 Kg
- Drawer loading capacity: 40 Kg
- Inside dimensions:  
4 drawers 570x420x60 mm  
1 drawer 570x420x130 mm  
1 drawer 570x420x270 mm



LxPxH mm	kg	code	1
814x575x1005	75	U05190516	1



### 519 RS6/3NMA

RACING roller cabinet with AUTOMOTIVE assortment 495 MAA (155 pcs.)

kg	code	1
90	U05191627	1



### 519 RS6/3MMM

RACING roller cabinet with assortment for MAINTENANCE 495 MB (156 pcs.)

kg	code	1
91	U05191628	1



3  
MODULES



### 519 RS7/3V

RACING roller cabinet - 7 drawers (empty)

- Work top in non-scratch Aluminium (2 mm)
- 15 mm wooden layer integrated under the worktop
- Soft touch double handle integrated in the worktop
- Innovative rail system integrated in the worktop to fit accessories (519 ACT range)
- Shock resistant profiles on sides and drawers
- Fully opening drawers on telescopic ball-bearing slides
- Drawers slide with soft closing system
- Opportunity to store 3 modules in each drawer
- Drawers with anodized Aluminium handles
- Quick drawer opening system
- Oil-proof rubber mats inside
- Centralized locking system
- Side panels arranged for mounting optional accessories (516 AC)
- Oil-proof rubber wheels (Ø 125 mm): two fixed and two swivelling (both with brake)
- Sheet steel casing and drawers with epoxy process, colour red RAL 3020
- Maximum loading capacity: 900 Kg
- Drawer loading capacity: 40 Kg
- Inside dimensions:  
5 drawers 570x420x60 mm; 1 drawer 570x420x130 mm; 1 drawer 570x420x270 mm

LxPxH mm	kg	code	1
814x575x1005	77	U05190507	1

3  
MODULES



### 519 RS8/3V

RACING roller cabinet - 8 drawers (empty)

- Work top in non-scratch Aluminium (2 mm)
- 15 mm wooden layer integrated under the worktop
- Soft touch double handle integrated in the worktop
- Innovative rail system integrated in the worktop to fit accessories (519 ACT range)
- Shock resistant profiles on sides and drawers
- Fully opening drawers on telescopic ball-bearing slides
- Drawers slide with soft closing system
- Opportunity to store 3 modules in each drawer
- Drawers with anodized Aluminium handles
- Quick drawer opening system
- Oil-proof rubber mats inside
- Centralized locking system
- Side panels arranged for mounting optional accessories (516 AC)
- Oil-proof rubber wheels (Ø 125 mm): two fixed and two swivelling (both with brake)
- Sheet steel casing and drawers with epoxy process, colour red RAL 3020
- Maximum loading capacity: 900 Kg
- Drawer loading capacity: 40 Kg
- Inside dimensions:  
6 drawers 570x420x60 mm; 2 drawers 570x420x130 mm



LxPxH mm	kg	code	1
814x575x1005	79	U05190508	1



## 519 RS8/3MM

RACING roller cabinet with assortment for MAINTENANCE 495 MC (300 pcs.)

Kg	code	
106	U05192632	1



4  
MODULES



## 519 RS6/4V

RACING roller cabinet - 6 drawers (empty)

- Work top in non-scratch Aluminium (2 mm)
- 15 mm wooden layer integrated under the worktop
- Soft touch double handle integrated in the worktop
- Innovative rail system integrated in the worktop to fit accessories (519 ACT range)
- Shock resistant profiles on sides and drawers
- Fully opening drawers on telescopic ball-bearing slides
- Drawers slide with soft closing system
- Opportunity to store 4 modules in each drawer
- Drawers with anodized Aluminium handles
- Quick drawer opening system
- Oil-proof rubber mats inside
- Centralized locking system
- Side panels arranged for mounting optional accessories (516 AC)
- Oil-proof rubber wheels (Ø 125 mm): two fixed and two swivelling (both with brake)
- Sheet steel casing and drawers with epoxy process, colour red RAL 3020
- Maximum loading capacity: 1.000 Kg
- Drawer loading capacity: 45 Kg
- Inside dimensions:  
4 drawers 760x420x60 mm  
1 drawer 760x420x130 mm  
1 drawer 760x420x270 mm

LxPxH mm	Kg	code	
1004x575x1005	89	U05190546	1



## 519 RS6/4MM

RACING roller cabinet with assortment for MAINTENANCE 495 MC (300 pcs.)

Kg	code	
116	U05190632	1



4  
MODULES



## 519 RS6/4NV

RACING roller cabinet - 6 drawers (empty)

- Work top in non-scratch Aluminium (2 mm)
- 15 mm wooden layer integrated under the worktop
- Soft touch double handle integrated in the worktop
- Innovative rail system integrated in the worktop to fit accessories (519 ACT range)
- Shock resistant profiles on sides and drawers
- Fully opening drawers on telescopic ball-bearing slides
- Drawers slide with soft closing system
- Opportunity to store 4 modules in each drawer
- Drawers with anodized Aluminium handles
- Quick drawer opening system
- Oil-proof rubber mats inside
- Centralized locking system
- Side panels arranged for mounting optional accessories (516 AC)
- Oil-proof rubber wheels (Ø 125 mm): two fixed and two swivelling (both with brake)
- Sheet steel casing and drawers with epoxy process, colour black RAL 9005
- Maximum loading capacity: 1.000 Kg
- Drawer loading capacity: 45 Kg
- Inside dimensions:  
4 drawers 760x420x60 mm  
1 drawer 760x420x130 mm  
1 drawer 760x420x270 mm

LxPxH mm	Kg	code	
1004x575x1005	89	U05190566	1



## 519 RS6/4NMM

RACING roller cabinet with assortment for MAINTENANCE 495 MC (300 pcs.)

Kg	code	
116	U05191632	1



# RACING 519



YouTube

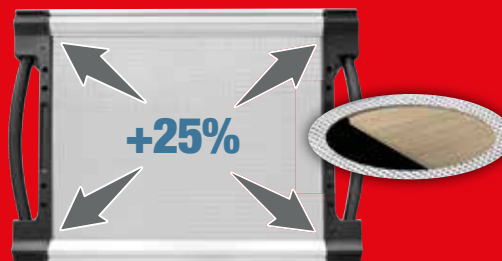

A NEW WIDER WORKTOP WITH DOUBLE HANDLE

DOUBLE LAYER

Above: 2 mm aluminium plate.  
Below: 15 mm wooden piece.



SLIDES WITH SOFT CLOSE SYSTEM



RUBBER BUMPERS ON STRUCTURE AND DRAWERS



NEW ALUMINIUM ERGONOMIC HANDLES WITH SELECTIVE OPENING



**5**  
MODULES**519 RS7/5V****RACING roller cabinet - 7 drawers (empty)**

- Work top in non-scratch Aluminium (2 mm)
- 15 mm wooden layer integrated under the worktop
- Soft touch double handle integrated in the worktop
- Innovative rail system integrated in the worktop to fit accessories (519 ACT range)
- Shock resistant profiles on sides and drawers
- Fully opening drawers on telescopic ball-bearing slides
- Drawers slide with soft closing system
- Opportunity to store 5 modules in each drawer
- Drawers with anodized Aluminium handles
- Quick drawer opening system
- Oil-proof rubber mats inside
- Centralized locking system
- Side panels arranged for mounting optional accessories (516 AC)
- Oil-proof rubber wheels (Ø 160 mm): two fixed and two swivelling (both with brake)
- Sheet steel casing and drawers with epoxy process, colour red RAL 3020
- Maximum loading capacity: 1.100 Kg
- Drawer loading capacity: 45 Kg
- Inside dimensions:  
5 drawers 950x420x60 mm; 1 drawer 950x420x130 mm; 1 drawer 950x420x270 mm

LxPxH mm	Kg	code	
1194x575x1035	106	U05190556	1

**3**  
MODULES**519 RB07/3V****RACING roller cabinet with side door - 7 drawers (empty)**

- Work top in non-scratch Aluminium (2 mm)
- 15 mm wooden layer integrated under the worktop
- Soft touch double handle integrated in the worktop
- Innovative rail system integrated in the worktop to fit accessories (519 ACT range)
- Shock resistant profiles on sides and drawers
- Fully opening drawers on telescopic ball-bearing slides
- Drawers slide with soft closing system
- Opportunity to store 3 modules in each drawer
- Drawers with anodized Aluminium handles
- Quick drawer opening system
- Oil-proof rubber mats inside
- Side cabinet with lockable door
- Removable plastic box on side cabinet
- Centralized locking system
- Side panels arranged for mounting optional accessories (516 AC)
- Oil-proof rubber wheels (Ø 160 mm): two fixed and two swivelling (both with brake)
- Sheet steel casing and drawers with epoxy process, colour red RAL 3020
- Maximum loading capacity: 1.100 Kg
- Drawer loading capacity: 40 Kg
- Inside dimensions:  
5 drawers 570x420x60 mm; 1 drawer 570x420x130 mm; 1 drawer 570x420x200 mm
- Side cabinet: 380x400x720 mm

LxPxH mm	Kg	code	
1194x575x1035	119	U05190097	1

**3**  
MODULES**519 RBU6/3V****RACING mobile workbench - 6 drawers (empty)**

- Multilayer wooden top
- Retractable wheels operated by the rotating metal handle
- Fully opening drawers on telescopic ball-bearing slides with oil-proof rubber mats inside
- Shock resistant profiles on drawers
- Opportunity to store 3 modules in each drawer
- Drawers with anodized Aluminium handles
- Quick drawer opening system
- Centralized locking system
- Side and rear panels arranged for mounting of optional accessories
- Side cabinet with lockable door
- Oil-proof rubber wheels (Ø 125 mm), two fixed and two swivelling
- Sheet steel casing with epoxy process, red RAL 3020, black RAL 9005
- Possibility to equip with a vice on the work top
- Possibility to equip with a vertical perforated panel JET.A6M5
- Maximum static load: 1000 kg
- Maximum loading capacity of the drawers : 40 kg
- Inside dimensions of the drawers:  
3 drawers 570 x420x60 mm  
2 drawers 570 x420x130 mm  
1 drawer 570 x420x200 mm
- Side compartment: 380x704x524 mm

LxPxH mm	Kg	code	
1212x670x1000	128	U05190098	1

**CREATE THE IDEAL ROLLER CABINET FOR YOUR JOB.**

The new worktop has an integrated system that allows to fix a new range of specific accessories.

Together with the use of standard side accessories (page 200) you can turn your RACING into a real professional workstation.



YouTube



### 519 ACT1

#### Laptop holder

- Accessory dedicated only for the worktop of RACING 519 RS roller cabinets
- Can fit a laptop of a tablet
- Adjustable in different positions
- Compatible with 3, 4 or 5 modules roller cabinets
- RAL 9005 painted steel

axb mm	kg	code	
220x320	2,5	U05190301	1



### 519 ACT4

#### Panel for documents and foam modules

- Accessory dedicated only for the worktop of RACING 519 RS roller cabinets
- Would be used for documents
- Designed to hold up to 3 foam modules
- Compatible with 3, 4 or 5 modules roller cabinets
- RAL 9005 painted steel

axb mm	kg	code	
440x570	3	U05190304	1



### 519 ACT7

#### Wooden top M4 (965 mm)

- Accessory dedicated only for the worktop of RACING 519 RS roller cabinets
- Multilayer wooden top (30 mm)
- Compatible with 3, 4 or 5 modules roller cabinets

LxPxH mm	kg	code	
965x600x28	15	U05190307	1



### 519 ACT2

#### Bottle and paper roll holder

- Accessory dedicated only for the worktop of RACING 519 RS roller cabinets
- Adds to the worktop a bottle holder
- Paper roll holder integrated
- Compatible with 3, 4 or 5 modules roller cabinets
- RAL 9005 painted steel

LxPxH mm	kg	code	
200x550x150	4,2	U05190302	1



### 519 ACT5

#### Document holder

- Accessory dedicated only for the worktop of RACING 519 RS roller cabinets
- Can hold A4 format documents
- Compatible with 3, 4 or 5 modules roller cabinets
- RAL 9005 painted steel

axb mm	gr	code	
450x250	900	U05190305	1



### 519 ACT8

#### Wooden top M5 (1155 mm)

- Accessory dedicated only for the worktop of RACING 519 RS roller cabinets
- Multilayer wooden top (30 mm)
- Compatible with 3, 4 or 5 modules roller cabinets

LxPxH mm	kg	code	
1155x600x28	17,6	U05190308	1



### 519 ACT3

#### Drawers locking bar

- Accessory dedicated only for RACING 519 RS roller cabinets
- Locks opening of all the drawers
- To be closed with a spare lock (not included)
- Compatible with 3, 4 or 5 modules roller cabinets
- RAL 3020 painted steel

LxH mm	kg	code	
115x795	4,3	U05190303	1



### 519 ACT6

#### Wooden top M3 (775 mm)

- Accessory dedicated only for the worktop of RACING 519 RS roller cabinets
- Multilayer wooden top (30 mm)
- Compatible with 3, 4 or 5 modules roller cabinets

LxPxH mm	kg	code	
800x600x28	11,5	U05190306	1



### 519 ACT9

#### Wooden top for vice

- Accessory dedicated only for the worktop of RACING 519 RS roller cabinets
- Multilayer wooden top (28 mm)
- Compatible with 3, 4 or 5 modules roller cabinets

LxPxH mm	kg	code	
600x300x28	4,3	U05190309	1



### 519 ACT10

#### Back hooks

- Accessory dedicated only for the worktop of RACING 519 RS roller cabinets
- Allows to hook cables and long objects
- 2 pieces included
- Compatible with 3, 4 or 5 modules roller cabinets

gr	code	
800	U05190310	1



### 519 ACT11

#### Perforated panel with shelf

- Accessory dedicated only for the worktop of RACING 519 RS roller cabinets
- Steel resistant structure
- Perforated panel suitable with tools hooks (not included)
- Metal shelf adjustable with 30° angle
- Compatible with 3, 4 or 5 modules roller cabinets
- RAL 9005 painted steel

axb mm	code	
800x610	U05190311	1



### 519 ACT12

#### Double perforated panel

- Accessory dedicated only for the worktop of RACING 519 RS roller cabinets
- Steel resistant structure
- Double perforated panel suitable with tools hooks (not included)
- Compatible with 3, 4 or 5 modules roller cabinets
- RAL 9005 painted steel

axb mm	code	
800x610	U05190312	1



### 519 ACT13

#### Perforated/flat panel with shelf

- Accessory dedicated only for the worktop of RACING 519 RS roller cabinets
- Steel resistant structure
- Perforated panel suitable with tools hooks (not included)
- Flat panel for documents
- Metal shelf adjustable with 30° angle
- Compatible with 3, 4 or 5 modules roller cabinets
- RAL 9005 painted steel

axb mm	code	
800x610	U05190313	1



### 519 ACT14

#### Triple shelf

- Accessory dedicated only for the worktop of RACING 519 RS roller cabinets
- Steel resistant structure
- 3 metal shelves adjustable with 30° angle
- Compatible with 3, 4 or 5 modules roller cabinets
- RAL 9005 painted steel

axb mm	code	
800x610	U05190314	1



### 519 ACT15

#### Transportation kit for RACING chest

- Accessory dedicated only for the drawers chest RACING RSC4
- Includes: Metal handle; Wheels (Ø 125 mm): two fixed and two swivelling, one of which has a brake

code	
U05190315	1



### 519 SA

#### Spare lock

- For current models 513 B6, 514 B6, 516 SP, 519 R
- For previous models 513 BX, 518S, 518 SP, 518 SX, 519 RX

code	
U05190070Q	1



### 519 SB

#### Dividers

- For current models 513 B6, 514 B6, 516 SP, 519 R
- For previous models 513 BX, 518S, 518 SP, 518 SX, 519 RX
- For drawers with depth 420 mm

H mm	code	
50	U05190022	1
100	U05190023	1



### 519 SC

#### Spare slides

- For current models 513 B6, 516 SP, 516 S6XL, 519 R
- For previous models 516 S, 518 S, 518 SP

code	
U05190512Q	1



NEW

### 519 SD

#### Spare slides

- For models: 519 RS, 519 RBO, 519 RBU

code	
U05190513Q	1



1/2

### 519/233CNTX



Assortment in plastic tray (9 pcs.)

pcs	description	item/size
9	Socket bits for TORX® screws / 20-25-27-30-40-45-50-55-60	233 1/2 NTX
1	Plastic tray (empty)	519/233CNTXV

LxPxH mm	g	code	
104x188x45	700	U05190701	1

### 519/233CNTXV

Plastic tray (empty)

- For assortment 519/233CNTX - 519/234CN



LxPxH mm	code	
104x188x45	U05190701Q	1



1/2

### 519/233CNXZNV



Assortment in plastic tray (6 pcs.)

pcs	description	item/size
6	Socket bits for XZN screws / 6L-8L-10L-12L-14L-17L	233 1/2 NXZN
1	Plastic tray (empty)	519/233CNXZNV

LxPxH mm	g	code	
104x188x45	673	U05190702	1

### 519/233CNXZNV

Plastic tray (empty)

- For assortment 519/233CNXZNV



LxPxH mm	code	
104x188x45	U05190702Q	1

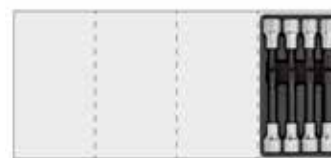

1/2

### 519/233CNXZNV



Assortment in plastic tray (8 pcs.)

pcs	description	item/size
8	Socket bits for XZN screws / 6-6L-8-8L-10-10L-12-12L	233 1/2 NXZN
1	Plastic tray (empty)	519/233CNXZNV

LxPxH mm	g	code	
104x188x45	689	U05190703	1

### 519/233CNXZNV

Plastic tray (empty)

- For assortment 519/233CNXZNV



LxPxH mm	code	
104x188x45	U05190703Q	1



1/2

### 519/234CN



Assortment in plastic tray (9 pcs.)

pcs	description	item/size
9	Socket bits for hex socket screws / 5-6-7-8-10-12-14-17-19	234 1/2 N
1	Plastic tray (empty)	519/233CNTXV

LxPxH mm	g	code	
104x188x45	890	U05190704	1

### 519/234CN

Plastic tray (empty)



LxPxH mm	code	
104x188x45	U05190704Q	1

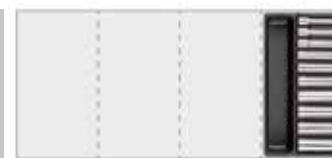

1/4

### 519/235AEL



Assortment in plastic tray (10 pcs.)

pcs	description	item/size
10	Long hexagonal sockets / 5-5.5-6-7-8-9-10-11-12-13-14	235 1/4 EL
1	Plastic tray (empty)	519/235AELV

LxPxH mm	g	code	
104x188x45	413	U05190705	1

### 519/235AELV

Plastic tray (empty)

- For assortment 519/235AEL



LxPxH mm	code	
104x188x45	U05190705Q	1



1/4

### 519/604AE



Assortment in plastic tray (14 pcs.)

pcs	description	item/size
11	Hexagonal sockets / 4-5-5.5-6-7-8-9-10-11-12-13	235 1/4 EN
1	Extensions	236 1/4/100
1	T-handle with sliding square drive	240 1/4
1	Spinner with handle	243 1/4
1	Plastic tray (empty)	519/604AV

LxPxH mm	g	code	
104x188x45	650	U05190709	1

### 519/604AE

Plastic tray (empty)



LxPxH mm	code	
104x188x45	U05190709Q	1

## Usag module

It is the system that allows you to better organize all the drawers of your USAG roller cabinet. Available in **plastic** or **bi-colour foam**.



**1/4 module**  
L104 x P188 mm

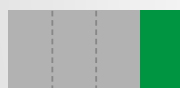

**3/4 module**  
L311 x P188 mm



**1 module**  
L415 x P188 mm



**2 modules**  
L415 x P376 mm

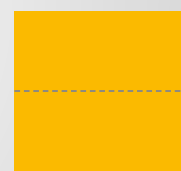

**3 modules**  
L415 x P565 mm

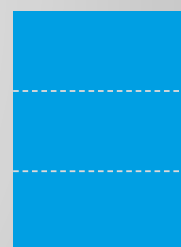

## The sizes available are

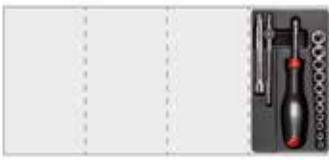

1/4

### 519/604APOL

Assortment in plastic tray (14 pcs.)

pcs	description	item/size
11	Hexagonal sockets, inch sizes / 5/32-3/16-7/32-1/4-9/32-5/16-11/32-3/8-7/16-1/2-9/16	235 1/4 EPN
1	Extensions	236 1/4/100
1	T-handle with sliding square drive	240 1/4
1	Spinner with handle	243 1/4
1	Plastic tray (empty)	519/604AV

LxPxH mm	g	code	
104x188x45	650	U05190710	1

### 519/604AV

Plastic tray (empty)

- For assortment 519/604AE e 519/604APOL



LxPxH mm	code	
104x188x45	U06040100Q	1

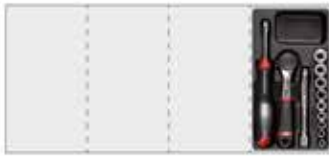

1/4

### 519/605AEA

Assortment in plastic tray (12 pcs.)

pcs	description	item/size
9	Hexagonal sockets /5,5-6-7-8-9-10-11-12-13	235 1/4 EN
1	Extensions	236 1/4/100
1	Reversible ratchet with sealed mechanism (certified IP51)	237 A 1/4
1	Spinner with handle	243 1/4
1	Plastic tray (empty)	519/605AEAV

LxPxH mm	g	code	
104x188x45	400	U05190738	1

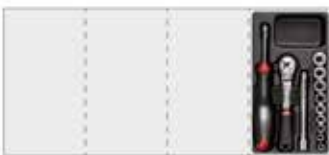

1/4

### 519/605AEB

Assortment in plastic tray (12 pcs.)

pcs	description	item/size
9	Hexagonal sockets /5,5-6-7-8-9-10-11-12-13	235 1/4 EN
1	Extensions	236 1/4/100
1	Reversible ratchet with sealed mechanism	237 B 1/4
1	Spinner with handle	243 1/4
1	Plastic tray (empty)	519/605AEAV

LxPxH mm	g	code	
104x188x45	400	U05190739	1



1/4

### 519/605AED

Assortment in plastic tray (12 pcs.)

pcs	description	item/size
9	Hexagonal sockets / 5,5-6-7-8-9-10-11-12-13	235 1/4 EN
1	Extensions	236 1/4/100
1	Sliding square ratchet	237 D 1/4
1	Spinner with handle	243 1/4
1	Plastic tray (empty)	519/605AEAV

LxPxH mm	g	code	
104x188x45	400	U05190806	1

### 519/605AEAV

Plastic tray (empty)

- For assortment 519/605AEA, 519/605AEB, 519/605AED



LxPxH mm	code	
104x188x45	U05190738Q	1



1/4

### 519/606AAPOL

Assortment in plastic tray (18 pcs.)

pcs	description	item/size
12	Hexagonal sockets, inch sizes /9/32-1/8-5/32-3/16-7/32-1/4-5/16-11/32-3/8-7/16-1/2-9/16	235 1/4 EPN
2	Extensions/50-100	236 1/4
1	Reversible ratchet with sealed mechanism (certified IP51)	237 A 1/4
1	T-handle with sliding square drive	240 1/4
1	Universal joint	241 1/4
1	Spinner with handle	243 1/4
1	Plastic tray (empty)	519/606AV

LxPxH mm	g	code	
104x188x45	400	U05190781	1



1/4

### 519/606ABPOL

Assortment in plastic tray (18 pcs.)

pcs	description	item/size
12	Hexagonal sockets, inch sizes /1/8-5/32-3/16-7/32-1/4-9/32-5/16-11/32-3/8-7/16-1/2-9/16	235 1/4 EPN
2	Extensions/50-100	236 1/4
1	Reversible ratchet with sealed mechanism	237 B 1/4
1	T-handle with sliding square drive	240 1/4
1	Universal joint	241 1/4
1	Spinner with handle	243 1/4
1	Plastic tray (empty)	519/606AV

LxPxH mm	g	code	
104x188x45	400	U05190782	1



1/4

### 519/606AEA

Assortment in plastic tray (19 pcs.)

pcs	description	item/size
13	Hexagonal sockets /4-4,5-5-5,5-6-7-8-9-10-11-12-13-14	235 1/4 EN
2	Extensions/50-100	236 1/4
1	Reversible ratchet with sealed mechanism (certified IP51)	237 A 1/4
1	T-handle with sliding square drive	240 1/4
1	Universal joint	241 1/4
1	Spinner with handle	243 1/4
1	Plastic tray (empty)	519/606AV

LxPxH mm	g	code	
104x188x45	500	U05190769	1



1/4

### 519/606AEAK

Assortment in plastic tray (19 pcs.)

pcs	description	item/size
13	Hexagonal sockets / 4-4,5-5-5,5-6-7-8-9-10-11-12-13-14	235 1/4 EN
2	Extensions/50-100	236 1/4
1	Reversible ratchet with revolving handle	237 1/4 AK
1	T-handle with sliding square drive	240 1/4
1	Universal joint	241 1/4
1	Spinner with handle	243 1/4
1	Plastic tray (empty)	519/606AV

LxPxH mm	g	code	
104x188x45	600	U05190773	1



1/4

### 519/606AEB

Assortment in plastic tray (19 pcs.)

pcs	description	item/size
13	Hexagonal sockets /4-4,5-5-5,5-6-7-8-9-10-11-12-13-14	235 1/4 EN
2	Extensions/50-100	236 1/4
1	Reversible ratchet with sealed mechanism	237 B 1/4
1	T-handle with sliding square drive	240 1/4
1	Universal joint	241 1/4
1	Spinner with handle	243 1/4
1	Plastic tray (empty)	519/606AV

LxPxH mm	g	code	
104x188x45	500	U05190770	1

### 519/606AV

Plastic tray (empty)

- For assortment 519/606AEA - 519/606AEB - 519/606AEAK - 519/606AAPOL - 519/606ABPOL



LxPxH mm	code	
104x188x45	U06060100Q	1

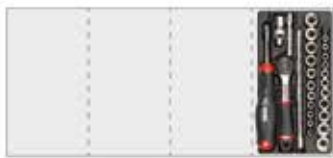

1/4

### 519/606AEPOL

Assortment in plastic tray (28 pcs.)



pcs	description	item/size
12	Hexagonal sockets /4-5-5,5-6-7-8-9-10-11-12-13-14	235 1/4 EN
11	Hexagonal sockets, inch sizes /5/32-3/16-7/32-1/4-9/32-5/16-11/32-3/8-7/16-1/2-9/16	235 1/4 EPN
2	Extensions/50-150	236 1/4
1	Reversible ratchet with sealed mechanism (certified IP51)	237 A 1/4
1	Universal joint	241 1/4
1	Spinner with handle	243 1/4
1	Plastic tray (empty)	519/606AEPOLV

LxPxH mm	kg	code	img
104x188x45	1,2	U05190801	1

### 519/606AEPOLV

Plastic tray (empty)

- For assortment 519/606AEPOL



LxPxH mm	code	img
104x188x45	U05190801Q	1



### 519/690C28

Assortment in plastic tray (28 pcs.)



pcs	description	item/size
3	Bits for slot-head screws -1/4" / 0,6x4,5-1x5,5-1,2x6,5	660
6	Bits for hex socket screws -1/4" / 2-2,5-3-4-5-6	660 E
4	Bits for PHILLIPS® screws -1/4" / 0-1-2-3	660 PH
4	Bits for POZIDRIV® - SUPADRIV® screws / 0-1-2-3-1/4"	660 PZ
6	Bits for TORX® Tamper Resistant screws -1/4" / T10-T15-T20-T25-T30-T40	660 STX
4	Bits for TORX® screws -1/4" / T6-T7-T8-T9	660 TX
1	Magnetic bit-holder with grip	690 A 1/4/180
1	Plastic tray (empty)	519/690C28V

LxPxH mm	gr	code	img
104x188x45	750	U05190807	1

### 519/690C28V

Plastic tray (empty)

- For assortment 519/690C28



LxPxH mm	code	img
104x188x45	U06900002Q	1

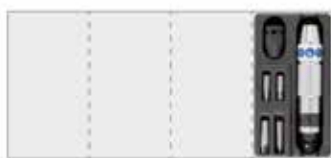

### 519/700

Assortment in plastic tray (6 pcs.)



pcs	description	item/size
2	Bits for slot-head screws - 5/16" / 1,2x8-1,6x10	661
2	Bits for PHILLIPS® screws - 5/16"	661 PH/2-3
1	Impact bit-holder sockets	685/1/2
1	Impact screwdriver	695 1/2
1	Plastic tray (empty)	519/700V

LxPxH mm	kg	code	img
104x188x45	1	U05190808	1

### 519/700V

Plastic tray (empty)

- For assortment 519/700



LxPxH mm	code	img
104x188x45	U07000002Q	1



1/2

### 519/235CEN

Assortment in plastic tray (22 pcs.)



pcs	description	item/size
22	Hexagonal sockets /8-9-10-11-12-13-14-15-16-17-18-19-21-22-23-24-26-27-28-29-30-32	235 1/2 EN
1	Plastic tray (empty)	519/235NV

LxPxH mm	code	img
311x188x45	U05190706	1



1/2

### 519/235CN

Assortment in plastic tray (22 pcs.)



pcs	description	item/size
22	Bihexagonal sockets /8-9-10-11-12-13-14-15-16-17-18-19-21-22-23-24-26-27-28-29-30-32	235 1/2 N
1	Plastic tray (empty)	519/235NV

LxPxH mm	code	img
311x188x45	U05190707	1

### 519/235NV

Plastic tray (empty)

- For assortment 519/235CN - 519/235CEN



LxPxH mm	code	img
311x188x45	U05190706Q	1



3/8

### 519/604BA

Assortment in plastic tray (18 pcs.)



pcs	description	item/size
14	Bihexagonal sockets /8-9-10-11-12-13-14-15-16-17-18-19-21-22	235 3/8
2	Extensions/125-250	236 3/8
1	Reversible ratchet with sealed mechanism (certified IP51)	237 A 3/8
1	Universal joint	241 3/8
1	Plastic tray (empty)	519/604BAV

LxPxH mm	kg	code	img
311x188x45	1,3	U05190711	1



3/8

### 519/604BB

Assortment in plastic tray (18 pcs.)



pcs	description	item/size
14	Bihexagonal sockets /8-9-10-11-12-13-14-15-16-17-18-19-21-22	235 3/8
2	Extensions/125-250	236 3/8
1	Reversible ratchet with sealed mechanism	237 B 3/8
1	Universal joint	241 3/8
1	Plastic tray (empty)	519/604BAV

LxPxH mm	kg	code	img
311x188x45	1,3	U05190805	1



3/8

### 519/604BEA

Assortment in plastic tray (18 pcs.)



pcs	description	item/size
14	Hexagonal sockets /8-9-10-11-12-13-14-15-16-17-18-19-21-22	235 3/8 E
2	Extensions/125-250	236 3/8
1	Reversible ratchet with sealed mechanism (certified IP51)	237 A 3/8
1	Universal joint	241 3/8
1	Plastic tray (empty)	519/604BAV

LxPxH mm	kg	code	img
311x188x45	1,6	U05190713	1



3/8

### 519/604BEB



Assortment in plastic tray (18 pcs.)

pcs	description	item/size
14	Hexagonal sockets /8-9-10-11-12-13-14-15-16-17-18-19-21-22	235 3/8 E
2	Extensions/125-250	236 3/8
1	Reversible ratchet with sealed mechanism	237 B 3/8
1	Universal joint	241 3/8
1	Plastic tray (empty)	519/604BAV

LxPxH mm	kg	code	
311x188x45	1,4	U05190724	1

### 519/604BAV

Plastic tray (empty)

- For assortment 519/604BA - 519/604BEA - 519/604BB - 519/604BEB



LxPxH mm	code	
311x188x45	U05190711Q	1



1/2

### 519/604CA



Assortment in plastic tray (15 pcs.)

pcs	description	item/size
13	Bihexagonal sockets /10-11-12-13-14-15-16-17-18-19-21-22-24	235 1/2 N
1	Extensions	236 1/2/125
1	Reversible ratchet with sealed mechanism (certified IP51)	237 A 1/2
1	Plastic tray (empty)	519/604CV

LxPxH mm	kg	code	
311x188x45	1,6	U05190726	1



1/2

### 519/604CB



Assortment in plastic tray (15 pcs.)

pcs	description	item/size
13	Bihexagonal sockets /10-11-12-13-14-15-16-17-18-19-21-22-24	235 1/2 N
1	Extensions	236 1/2/125
1	Reversible ratchet with sealed mechanism	237 B 1/2
1	Plastic tray (empty)	519/604CV

LxPxH mm	kg	code	
311x188x45	1,7	U05190735	1



1/2

### 519/604CEAK



Assortment in plastic tray (15 pcs.)

pcs	description	item/size
13	Hexagonal sockets /10-11-12-13-14-15-16-17-18-19-21-22-24	235 1/2 EN
1	Extensions	236 1/2/125
1	Reversible ratchet with revolving handle	237 1/2 AK
1	Plastic tray (empty)	519/604CV

LxPxH mm	kg	code	
311x188x45	1,9	U05190737	1



1/2

### 519/604CEAD



Assortment in plastic tray (15 pcs.)

pcs	description	item/size
13	Hexagonal sockets /10-11-12-13-14-15-16-17-18-19-21-22-24	235 1/2 EN
1	Extensions	236 1/2/125
1	Sliding square ratchet	237 D 1/2
1	Plastic tray (empty)	519/604CV

LxPxH mm	kg	code	
311x188x45	1,6	U05190800	1



1/2

### 519/604CEB



Assortment in plastic tray (15 pcs.)

pcs	description	item/size
13	Hexagonal sockets /10-11-12-13-14-15-16-17-18-19-21-22-24	235 1/2 EN
1	Extensions	236 1/2/125
1	Reversible ratchet with sealed mechanism	237 B 1/2
1	Plastic tray (empty)	519/604CV

LxPxH mm	kg	code	
311x188x45	1,7	U05190736	1

### 519/604CV

Plastic tray (empty)

- For assortment 519/604CA, 519/604CEA, 519/604CB, 519/604CEB, 519/604CEAK, 519/604CEAD

LxPxH mm	code	
311x188x45	U06040300Q	1



3/8

### 519/605BA



Assortment in plastic tray (20 pcs.)

pcs	description	item/size
15	Bihexagonal sockets /7-8-9-10-11-12-13-14-15-16-17-18-19-21-22	235 3/8
2	Extensions/125-250	236 3/8
1	Reversible ratchet with sealed mechanism (certified IP51)	237 A 3/8
1	T-handle with sliding square drive	240 3/8 N
1	Universal joint	241 3/8
1	Plastic tray (empty)	519/605BAV

LxPxH mm	kg	code	
311x188x45	1,5	U05190743	1



3/8

### 519/605BB



Assortment in plastic tray (20 pcs.)

pcs	description	item/size
15	Bihexagonal sockets /7-8-9-10-11-12-13-14-15-16-17-18-19-21-22	235 3/8
2	Extensions/125-250	236 3/8
1	Reversible ratchet with sealed mechanism	237 B 3/8
1	T-handle with sliding square drive	240 3/8 N
1	Universal joint	241 3/8
1	Plastic tray (empty)	519/605BAV

LxPxH mm	kg	code	
311x188x45	1,6	U05190749	1



3/8

### 519/605BEA



Assortment in plastic tray (20 pcs.)

pcs	description	item/size
15	Hexagonal sockets /7-8-9-10-11-12-13-14-15-16-17-18-19-21-22	235 3/8 E
2	Extensions/125-250	236 3/8
1	Reversible ratchet with sealed mechanism (certified IP51)	237 A 3/8
1	T-handle with sliding square drive	240 3/8 N
1	Universal joint	241 3/8
1	Plastic tray (empty)	519/605BAV

LxPxH mm	kg	code	
311x188x45	1,6	U05190746	1



3/8

### 519/605BEB

Assortment in plastic tray (20 pcs.)



pcs	description	item/size
15	Hexagonal sockets /7-8-9-10-11-12-13-14-235 3/8 E 15-16-17-18-19-21-22	
2	Extensions/125-250	236 3/8
1	Reversible ratchet with sealed mechanism	237 B 3/8
1	T-handle with sliding square drive	240 3/8 N
1	Universal joint	241 3/8
1	Plastic tray (empty)	519/605BAV

LxPxH mm	Kg	code	
311x188x45	1,6	U05190757	1

### 519/605BAV

Plastic tray (empty)



- For assortment 519/605BA - 519/605BEA - 519/605BB - 519/605BEB

LxPxH mm	code	
311x188x45	U05190743Q	1



1/2

### 519/605CEB

Assortment in plastic tray (19 pcs.)



pcs	description	item/size
16	Bihexagonal sockets /10-11-12-13-14-15-16-17-18-19-21-22-24-27-30-32	235 1/2 N
1	Extensions	236 1/2/125
1	Reversible ratchet with sealed mechanism (certified IP51)	237 A 1/2
1	Universal joint	241 1/2
1	Plastic tray (empty)	519/605CAV

LxPxH mm	Kg	code	
311x188x45	2,3	U05190759	1



1/2

### 519/605CAV

Plastic tray (empty)



pcs	description	item/size
16	Bihexagonal sockets /10-11-12-13-14-15-16-17-18-19-21-22-24-27-30-32	235 1/2 N
1	Extensions	236 1/2/125
1	Reversible ratchet with sealed mechanism	237 B 1/2
1	Universal joint	241 1/2
1	Plastic tray (empty)	519/605CAV

LxPxH mm	Kg	code	
311x188x45	2,4	U05190767	1



1/2

### 519/605CEA

Assortment in plastic tray (19 pcs.)



pcs	description	item/size
16	Hexagonal sockets /10-11-12-13-14-15-16-17-18-19-21-22-24-27-30-32	235 1/2 EN
1	Extensions	236 1/2/125
1	Reversible ratchet with sealed mechanism (certified IP51)	237 A 1/2
1	Universal joint	241 1/2
1	Plastic tray (empty)	519/605CAV

LxPxH mm	Kg	code	
311x188x45	2,4	U05190766	1



1/2

### 519/605CEA

Assortment in plastic tray (19 pcs.)



pcs	description	item/size
16	Hexagonal sockets /10-11-12-13-14-15-16-17-18-19-21-22-24-27-30-32	235 1/2 EN
1	Extensions	236 1/2/125
1	Reversible ratchet with sealed mechanism	237 B 1/2
1	Universal joint	241 1/2
1	Plastic tray (empty)	519/605CAV

LxPxH mm	Kg	code	
311x188x45	2,4	U05190768	1

### 519/605CAV

Plastic tray (empty)



- For assortment 519/605CA - 519/605CB - 519/605CEA - 519/605CEB

LxPxH mm	code	
311x188x45	U05190759Q	1



1/4 1/2

### 519/606ACEA

Assortment in plastic tray (30 pcs.)



pcs	description	item/size
14	Hexagonal sockets /10-11-12-13-14-15-16-17-18-19-21-22-24-27	235 1/2 EN
9	Hexagonal sockets /5,5-6-7-8-9-10-11-12-13	235 1/4 EN
1	Extensions	236 1/2/125
1	Extensions	236 1/4/100
1	Reversible ratchet with sealed mechanism (certified IP51)	237 A 1/2
1	Reversible ratchet with sealed mechanism (certified IP51)	237 A 1/4
1	Universal joint	241 1/2
1	Universal joint	241 1/4
1	Spinner with handle	243 1/4
1	Plastic tray (empty)	519/606ACEAV

LxPxH mm	Kg	code	
311x188x45	2,3	U05190803	1



### 519/606ACEB

Assortment in plastic tray (30 pcs.)



pcs	description	item/size
14	Hexagonal sockets /10-11-12-13-14-15-16-17-18-19-21-22-24-27	235 1/2 EN
9	Hexagonal sockets /5,5-6-7-8-9-10-11-12-13	235 1/4 EN
1	Extensions	236 1/2/125
1	Extensions	236 1/4/100
1	Reversible ratchet with sealed mechanism	237 B 1/2
1	Reversible ratchet with sealed mechanism	237 B 1/4
1	Universal joint	241 1/2
1	Universal joint	241 1/4
1	Spinner with handle	243 1/4
1	Plastic tray (empty)	519/606ACEAV

LxPxH mm	Kg	code	
311x188x45	2,3	U05190804	1

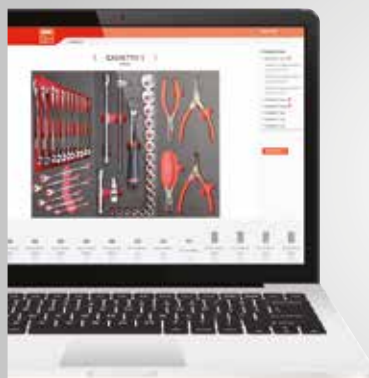

## CREATE YOUR IDEAL ASSORTMENT!

Go to [kitplanner-gb.usag.it](http://kitplanner-gb.usag.it) or frame the QR code





## 519/606ACEAV

### Plastic tray (empty)

- For assortment 519/606ACEA - 519/606ACEB



LxPxH mm	code	
415x188x45	U05190803Q	1



1/2

## 519/606CA

### Assortment in plastic tray (23 pcs.)

pcs	description	item/size
19	Bihexagonal sockets /8-9-10-11-12-13-14-15-16-17-18-19-21-22-23-24-27-30-32	235 1/2 N
2	Extensions/125-250	236 1/2
1	Reversible ratchet with sealed mechanism (certified IP51)	237 A 1/2
1	Universal joint	241 1/2
1	Plastic tray (empty)	519/606CAV

LxPxH mm	kg	code	
311x188x45	2,9	U05190793	1



1/2

## 519/606CB

### Assortment in plastic tray (23 pcs.)

pcs	description	item/size
19	Bihexagonal sockets / 8-9-10-11-12-13-14-15-16-17-18-19-21-22-23-24-27-30-32	235 1/2 N
2	Extensions/125-250	236 1/2
1	Reversible ratchet with sealed mechanism	237 B 1/2
1	Universal joint	241 1/2
1	Plastic tray (empty)	519/606CAV

LxPxH mm	kg	code	
311x188x45	3	U05190795	1



1/2

## 519/606CEA

### Assortment in plastic tray (23 pcs.)

pcs	description	item/size
19	Hexagonal sockets /8-9-10-11-12-13-14-15-16-17-18-19-21-22-23-24-27-30-32	235 1/2 EN
2	Extensions/125-250	236 1/2
1	Reversible ratchet with sealed mechanism (certified IP51)	237 A 1/2
1	Universal joint	241 1/2
1	Plastic tray (empty)	519/606CAV

LxPxH mm	kg	code	
311x188x45	3	U05190794	1



1/2

## 519/606CEAK

### Assortment in plastic tray (23 pcs.)

pcs	description	item/size
19	Hexagonal sockets /8-9-10-11-12-13-14-15-16-17-18-19-21-22-23-24-27-30-32	235 1/2 EN
2	Extensions/125-250	236 1/2
1	Reversible ratchet with revolving handle	237 1/2 AK
1	Universal joint	241 1/2
1	Plastic tray (empty)	519/606CAV

LxPxH mm	kg	code	
311x188x45	3,3	U05190797	1



1/2

## 519/606CEB

### Assortment in plastic tray (23 pcs.)

pcs	description	item/size
19	Hexagonal sockets / 8-9-10-11-12-13-14-15-16-17-18-19-21-22-23-24-27-30-32	235 1/2 EN
2	Extensions/125-250	236 1/2
1	Reversible ratchet with sealed mechanism	237 B 1/2
1	Universal joint	241 1/2
1	Plastic tray (empty)	519/606CAV

LxPxH mm	kg	code	
311x188x45	3	U05190796	1



1/2

## 519/606CEBP

### Assortment in plastic tray (23 pcs.)

pcs	description	item/size
19	Hexagonal sockets / 8-9-10-11-12-13-14-15-16-17-18-19-21-22-23-24-27-30-32	235 1/2 EN
2	Extensions/125-250	236 1/2
1	Reversible ratchet with socket retaining system	237 1/2 BP
1	Universal joint	241 1/2
1	Plastic tray (empty)	519/606CAV

LxPxH mm	kg	code	
311x188x45	3	U05190802	1

## 519/606CAV

### Plastic tray (empty)

- For assortment 519/606CA - 519/606CEA - 519/606CEB - 519/606CEB - 519/606CEAK - 519/606CEBP

LxPxH mm	code	
311x188x45	U06060300Q	1



1/2

## 519/606CAPOL

### Assortment in plastic tray (15 pcs.)

pcs	description	item/size
11	Bihexagonal sockets, inch sizes /3/8-7/16-1/2-9/16-19/32-5/8-21/32-11/16-3/4-13/16-7/8	235 1/2 PN
2	Extensions/125-250	236 1/2
1	Reversible ratchet with sealed mechanism (certified IP51)	237 A 1/2
1	Universal joint	241 1/2
1	Plastic tray (empty)	519/606CAPOLV

LxPxH mm	kg	code	
311x188x45	2	U05190798	1



1/2

## 519/606CBPOL

### Assortment in plastic tray (15 pcs.)

pcs	description	item/size
11	Bihexagonal sockets, inch sizes / 3/8-7/16-1/2-9/16-19/32-5/8-21/32-11/16-3/4-13/16-7/8	235 1/2 PN
2	Extensions/125-250	236 1/2
1	Reversible ratchet with sealed mechanism	237 B 1/2
1	Universal joint	241 1/2
1	Plastic tray (empty)	519/606CAPOLV

LxPxH mm	kg	code	
311x188x45	2	U05190799	1

## 519/606CAPOLV

### Plastic tray (empty)

- For assortment 519/606CAPOL, 519/606CBPOL

LxPxH mm	code	
311x188x45	U05190798Q	1



## 519 SK692V

### Plastic tray (4 compartments)

- Compartments dimension: 90x7 5mm, 185x175 mm, 285x75 mm, 98x142 mm

LxPxH mm	gr	code	
415x188x45	100	U05190832	1



## 519 SKV6



### Plastic tray (12 compartments)

- Compartments dimension: 3 with size 62x50, 6 with size 92x50 mm and 3 with size 140x50 mm

LxPxH mm	kg	code	
415x188x45	100	U05190827	1



## 1000 V

### 519/085EX



### Assortment in plastic tray (5 pcs.)

pcs	description	item/size
1	Half-round extra-long nose pliers with straight jaws - 1000 V	081 EX/160
1	Combination pliers - 1000 V	085 EX/180
1	Diagonal cutting nippers - 1000 V	087 EX/160
1	Lock-grip pliers with concave jaws	134/250
1	Box-joint adjustable pliers	180 C/250
1	Plastic tray (empty)	519/150AEXV

LxPxH mm	kg	code	
415x188x45	1,7	U05190898	1

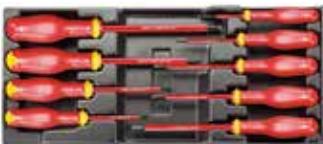

## 1000 V

### 519/091H



### Assortment in plastic tray (9 pcs.)

pcs	description	item/size
6	Screwdrivers for slot-head screws - 1000 V /0, 4x2, 5x50-0, 5x3x75-0, 6x3, 5x100-0, 8x4x100-1x5, 5x125-1, 2x6, 5x150	091
3	Screwdrivers for PHILLIPS® screws - 1000 V 091 PH /0x75-1x100-2x125	
1	Plastic tray (empty)	519/091HV

LxPxH mm	kg	code	
415x188x45	800	U05190758	1

### 519/091HV

### Plastic tray (empty)

- For assortment 519/091H



LxPxH mm	code	
415x188x45	U05190337Q	1



## 519/127C



### Assortment in plastic tray (4 pcs.)

pcs	description	item/size
1	Pliers with straight nose for internal circlips	127 C/19÷60
1	Pliers with nose bent at 90° for internal circlips	127 CP/19÷60
1	Pliers with straight nose for external circlips	128 C/19÷60
1	Pliers with nose bent at 90° for external circlips	128 CP/19÷60
1	Plastic tray (empty)	519/127CV

LxPxH mm	kg	code	
415x188x45	800	U05190717	1

### 519/127CV

### Plastic tray (empty)

- For assortment 519/127C



LxPxH mm	code	
415x188x45	U05190717Q	1



## 519/127N



### Assortment in plastic tray (4 pcs.)

pcs	description	item/size
1	Pliers with straight nose for internal circlips	127 N/19÷60
1	Pliers with nose bent at 90° for internal circlips	127 PN/19÷60
1	Pliers with straight nose for external circlips	128 N/19÷60
1	Pliers with nose bent at 90° for external circlips	128 PN/19÷60
1	Plastic tray (empty)	519/127NV

LxPxH mm	kg	code	
415x188x45	1,1	U05190716	1

### 519/127NV

### Plastic tray (empty)

- For assortment 519/127N



LxPxH mm	code	
415x188x45	U05190301Q	1



## 519/134



### Assortment in plastic tray (2 pcs.)

pcs	description	item/size
1	Lock-grip pliers with concave jaws	134/250
1	Semiautomatic adjustable pliers	180 B/250
1	Plastic tray (empty)	519/134V

LxPxH mm	kg	code	
415x188x45	1,1	U05190830	1

### 519/134V

### Plastic tray (empty)

- For assortment 519/134



LxPxH mm	code	
415x188x45	U05190830Q	1



## 519/150AX



### Assortment in plastic tray (5 pcs.)

pcs	description	item/size
1	Half-round extra-long nose pliers with straight jaws	133 AX/160
1	Lock-grip pliers with concave jaws	134/250
1	Combination pliers	150 AX/180
1	Box-joint adjustable pliers	180 C/250
1	Heavy-duty diagonal cutting nippers	188 AX/160
1	Plastic tray (empty)	519/150AEXV

LxPxH mm	kg	code	
415x188x45	1,6	U05190850	1

### 519/150AEXV

### Plastic tray (empty)

- For assortment 519/150AX - 519/085EX



LxPxH mm	code	
415x188x45	U05190853Q	1



## 519/150CX



### Assortment in plastic tray (5 pcs.)

pcs	description	item/size
1	Half-round extra-long nose pliers with straight jaws	133 CX/160
1	Lock-grip pliers with concave jaws	134/250
1	Combination pliers	150 CX/180
1	Box-joint adjustable pliers	180 C/250
1	Heavy-duty diagonal cutting nippers	188 CX /160

LxPxH mm	kg	code	
415x188x45	1,4	U05190852	1



1/2

### 519/233A

Assortment in plastic tray (16 pcs.)

pcs	description	item/size
2	Socket bits for splined hexagonal screws (RIBE)/9L-10L	233 1/2 NS
4	Socket bits for TORX® screws / T40L-T45L-T55L-T70L	233 1/2 NTX
6	Socket bits for XZN screws / 6L-8L-9L-10L-12L-14L	233 1/2 NXZN
4	Socket bits for hex socket screws / 5L2-6L-7L-8L	234 1/2 N
1	Plastic tray (empty)	519/233AV

LxPxH mm	kg	code	
415x188x45	1,9	U05190820	1

### 519/233AV

Plastic tray (empty)

- For assortment 519/233A



LxPxH mm	code	
415x188x45	U05190820Q	1



1/2

### 519/234C

Assortment in plastic tray (22 pcs.)

pcs	description	item/size
7	Socket bits for TORX® screws / T27-T30-T40-T45-T50-T55-T60	233 1/2 NTX
8	Socket bits for hex socket screws / 5-6-7-8-10-12-14-17	234 1/2 N
7	TORX® sockets /E10-E12-E14-E16-E18-E20-E24	235 1/2 NTX
1	Plastic tray (empty)	519/234CV

LxPxH mm	kg	code	
415x188x45	1,9	U05190720	1

### 519/234CV

Plastic tray (empty)

- For assortment 519/234C



LxPxH mm	code	
415x188x45	U05190310Q	1



1/2

### 519/235LN

Assortment in plastic tray (10 pcs.)

pcs	description	item/size
10	Long bihexagonal sockets / 10-11-12-13-14-15-16-17-19-22	235 1/2 LN
1	Plastic tray (empty)	519/235LNV

LxPxH mm	kg	code	
415x188x45	1,4	U05190829	1

### 519/235LNV

Plastic tray (empty)

- For assortment 519/235LN



LxPxH mm	code	
415x188x45	U05190829Q	1



### 519/252A1

Assortment in plastic tray (11 pcs.)

pcs	description	item/size
11	Double ended open jaw wrenches / 6x7-8x9-10x11-12x13-14x15-16x17-18x19-21x23-22x24-27x29-30x32	252 N
1	Plastic tray (empty)	519/252A1V

LxPxH mm	kg	code	
415x188x45	2,3	U05190821	1

### 519/252A1V

Plastic tray (empty)

- For assortment 519/252A1



LxPxH mm	code	
415x188x45	U05190821Q	1



### 519/280HATX

Assortment in plastic tray (7 pcs.)

pcs	description	item/size
7	Angled keys with handgrip for TORX® screws /T10-T15-T20-T25-T27-T30-T40	280 HATX
1	Plastic tray (empty)	519/280HATXV

LxPxH mm	gr	code	
415x188x45	617	U05190862	1

### 519/280HATXV

Plastic tray (empty)

- For assortment 519/280HATX



LxPxH mm	code	
415x188x45	U05190355Q	1



### 519/280HG

Assortment in plastic tray (7 pcs.)

pcs	description	item/size
7	Angled hexagon keys with bimaterial handgrip/3-4-5-6-7-8-10	280 HG
1	Plastic tray (empty)	519/280HGV

LxPxH mm	kg	code	
415x188x45	1	U05191860	1



### 519/280HGTS

Assortment in plastic tray (7 pcs.)

pcs	description	item/size
7	Angled hexagon keys with spherical head and bimaterial handgrip / 3-4-5-6-7-8-10	280 HGTS
1	Plastic tray (empty)	519/280HGV

LxPxH mm	kg	code	
415x188x45	1	U05191861	1

### 519/280HGV

Plastic tray (empty)

- For assortment 519/280HG, 519/280HGTS



LxPxH mm	code	
415x188x45	U05190354Q	1

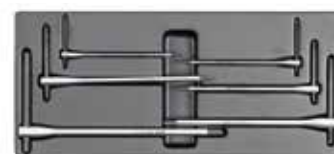

### 519/280TK

Assortment in plastic tray (6 pcs.)

pcs	description	item/size
6	T-handle hexagon keys with sliding bar / 2,5-3-4-5-6-8	280 TK
1	Plastic tray (empty)	519/280TKV

LxPxH mm	gr	code	
415x188x45	900	U05190787	1

## 519/280TKV

### Plastic tray (empty)

- For assortment 519/280TK



LxPxH mm	code	
415x188x45	U05190439Q	1



## 519/283

### Assortment in plastic tray (8 pcs.)

pcs	description	item/size
8	Double ended offset bihexagonal ring wrenches /6x7-8x9-8x10-10x11-12x13-14x15-16x17-18x19	283
1	Plastic tray (empty)	519/283A1V

LxPxH mm	kg	code	
415x188x45	1,2	U05190899	1

## 519/283A1V

### Plastic tray (empty)

- For assortment 519/283



LxPxH mm	code	
415x188x45	U05190822Q	1



## 519/285A1

### Assortment in plastic tray (25 pcs.)

pcs	description	item/size
9	Set of 9 angled hexagon keys / 1,5-2-2,5-3-4-5-6-8-10	280 S9
16	Combination wrenches /6-7-8-9-10-11-12-13-14-15-16-17-18-19-22-24	285
1	Plastic tray (empty)	519/285A1V

LxPxH mm	kg	code	
415x188x45	2,1	U05190785	1

## 519/285A1V

### Plastic tray (empty)

- For assortment 519/285A1



LxPxH mm	code	
415x188x45	U05190348Q	1



## 519/285B2

### Assortment in plastic tray (4 pcs.)

pcs	description	item/size
4	Combination wrenches/27-29-30-32	285
1	Plastic tray (empty)	519/285B2V

LxPxH mm	kg	code	
415x188x45	2,3	U05190823	1

## 519/285B2V

### Plastic tray (empty)

- For assortment 519/285B2



LxPxH mm	code	
415x188x45	U05190823Q	1



## 519/285J16

### Assortment in plastic tray (16 pcs.)

pcs	description	item/size
16	Combination wrenches/ 6-7-8-9-10-11-12-13-14-15-16-17-18-19-22-24	285 J
1	Plastic tray (empty)	519/285J16V

LxPxH mm	kg	code	
415x188x45	2,1	U05190848	1



## 519/285J25

### Assortment in plastic tray (25 pcs.)

pcs	description	item/size
16	Combination wrenches/ 6-7-8-9-10-11-12-13-14-15-16-17-18-19-22-24	285 J
9	Set of 9 angled hexagon keys/ 1,5-2-2,5-3-4-5-6-8-10	280 S9
1	Plastic tray (empty)	519/285J16V

LxPxH mm	kg	code	
415x188x45	2,3	U05190849	1

## 519/285J16V

### Plastic tray (empty)

- For assortments 519/285J16 and 519/285J25



LxPxH mm	code	
415x188x45	U05190848Q	1



## 519/285KA1

### Assortment in plastic tray (12 pcs.)

pcs	description	item/size
12	Reversible ratchet combination wrenches with locking ring /8-9-10-11-12-13-14-15-16-17-18-19	285 KA
1	Plastic tray (empty)	519/285KA1V

LxPxH mm	kg	code	
415x188x45	1,5	U05190788	1

## 519/285KA1V

### Plastic tray (empty)

- For assortment 519/285KA1



LxPxH mm	code	
415x188x45	U05190440Q	1



## 519/285KF

### Assortment in plastic tray (15 pcs.)

pcs	description	item/size
12	Hinged jointed reversible ratchet combination wrenches /8-9-10-11-12-13-14-15-16-17-18-19	285 KF
1	Adapter for 1/4" sockets for ratchet wrench 10 mm	
1	Adapter for 1/4" bits for ratchet wrench 10 mm	
1	Adapter for 1/2" sockets for ratchet wrench 19 mm	
1	Plastic tray (empty)	519/285KFV

LxPxH mm	kg	code	
415x188x45	1,5	U05190851	1

## 519/285KFV

### Plastic tray (empty)

- For assortment 519/285KF



LxPxH mm	code	
415x188x45	U05190851Q	1



## 519/291NA

### Assortment in plastic tray (10 pcs.)

pcs	description	item/size
10	Double ended hollow offset socket wrenches/ 8-10-11-12-13-14-16-17-18-19	
1	Plastic tray (empty)	519/291NAV

LxPxH mm	kg	code	
415x188x45	2,3	U05190824	1

## 519/291NAV

### Plastic tray (empty)

- For assortment 519/291NA



LxPxH mm	code	
415x188x45	U05190824Q	1



## 519/294

### Assortment in plastic tray (9 pcs.)

pcs	description	item/size
1	Shears for sheet steel	204/250
1	Adjustable wrenches with quick adjustment	294 AD/250
6	Pin punches /2x115-3x125-4x145-5x165-6x180-8x200	367
1	Professional tape rules with shockproof covering	981 A/3
1	Plastic tray (empty)	519/294V

LxPxH mm	kg	code	
415x188x45	1,6	U05190732	1

## 519/294V

### Plastic tray (empty)

- For assortment 519/294



LxPxH mm	code	
415x188x45	U05190309Q	1



## 519/299

### Assortment in plastic tray (5 pcs.)

pcs	description	item/size
5	Hexagonal socket spinners with grip / 6-7-8-10-13	299
1	Plastic tray (empty)	519/299V

LxPxH mm	kg	code	
415x188x45	966	U05190760	1

## 519/299V

### Plastic tray (empty)

- For assortment 519/299



LxPxH mm	code	
415x188x45	U05190344Q	1



## 519/322H

### Assortment in plastic tray (10 pcs.)

pcs	description	item/size
5	Screwdrivers for slot-head screws /0,5x3x75-0,8x4x100-1x5,5x125-1,2x6,5x150-1,6x8x175	322
1	Screwdrivers for slot-head screws / 0,8x4x30	322 N
1	Screwdrivers for PHILLIPS® screws	322 NPH/2x30
3	Screwdrivers for PHILLIPS® screws / 0x75-1x100-2x125	322 PH
1	Plastic tray (empty)	519/322HV

LxPxH mm	kg	code	
415x188x45	798	U05190772	1

## 519/322HV

### Plastic tray (empty)

- For assortment 519/322H



LxPxH mm	code	
415x188x45	U05190338Q	1



## 519/322STX

### Assortment in plastic tray (6 pcs.)

pcs	description	item/size
6	Screwdrivers for TORX® Tamper Resistant screws/T10-T15-T20-T25-T30-T40	322 STX
1	Plastic tray (empty)	519/322STXV

LxPxH mm	kg	code	
415x188x45	605	U05190831	1

## 519/322STXV

### Plastic tray (empty)

- For assortment 519/322STX



LxPxH mm	code	
415x188x45	U05190831Q	1



## 1000 V

### 519/324B

### Assortment in plastic tray (11 pcs.)

pcs	description	item/size
1	Screwdrivers for slot-head screws - 1000 V	091/0,8x4x100
1	Screwdrivers for PHILLIPS® screws - 1000 V	091 PH/1x100
1	Phase-testing screwdriver	110÷250V 321 F
4	Screwdrivers for slot-head screws /0,5x3x75-0,8x4x100-1x5,5x125-1,2x6,5x150	324
1	Screwdrivers for slot-head screws / 0,8x4x35	324 N
1	Screwdrivers for PHILLIPS® screws	324 NPH/2x35
2	Screwdrivers for PHILLIPS® screws / 1x75-2x100	324 PH
1	Plastic tray (empty)	519/324BV

LxPxH mm	kg	code	
415x188x45	876	U05190762	1

## 519/324BV

### Plastic tray (empty)

- For assortment 519/324B



LxPxH mm	code	
415x188x45	U05190342Q	1



## 519/324H

### Assortment in plastic tray (10 pcs.)

pcs	description	item/size
5	Screwdrivers for slot-head screws /0,5x3x75-0,8x4x100-1x5,5x125-1,2x6,5x150-1,2x8x200	324
1	Screwdrivers for slot-head screws/ 0,8x4x35	324 N
1	Screwdrivers for PHILLIPS® screws	324 NPH/2x35
3	Screwdrivers for PHILLIPS® screws / 0x75-1x75-2x100	324 PH
1	Plastic tray (empty)	519/324HV

LxPxH mm	kg	code	
415x188x45	1	U05190763	1

## 519/324HV

### Plastic tray (empty)

- For assortment 519/324H



LxPxH mm	code	
415x188x45	U05190340Q	1



### 519/324TX

Assortment in plastic tray (9 pcs.)

pcs	description	item/size
5	Screwdrivers for TORX® Tamper Resistant screws /T10x75-T15x75-T20x100-T25x100-T30x125	324 STX
4	Screwdrivers for TORX® screws / T6x50-T7x50-T8x50-T9x75	324 TX
1	Plastic tray (empty)	519/324TXV

LxPxH mm	g	code	
415x188x45	700	U05190764	1

### 519/324TXV

Plastic tray (empty)

- For assortment 519/324TX



LxPxH mm	code	
415x188x45	U05190341Q	1



### 519/366

Assortment in plastic tray (7 pcs.)

pcs	description	item/size
1	Ribbed chisels	351/200
2	Chisels	362/125-150
1	Cross cut chisel	364/125
2	Drift punches/3x125-4x150	366
1	Centre punches	368/4x125
1	Plastic tray (empty)	519/366V

LxPxH mm	Kg	code	
415x188x45	1	U05190740	1

### 519/366V

Plastic tray (empty)

- For assortment 519/366

LxPxH mm	code	
415x188x45	U05190312Q	1



### 519/382

Assortment in plastic tray (2 pcs.)

pcs	description	item/size
1	Mallets	376/35
1	Hammers for mechanics	382/500
1	Plastic tray (empty)	519/382V

LxPxH mm	Kg	code	
415x188x45	1,2	U05190741	1

### 519/382V

Plastic tray (empty)

- For assortment 519/382



LxPxH mm	code	
415x188x45	U05190318Q	1



### 519/382F

Assortment in plastic tray (8 pcs)

pcs	description	item/size
1	Chisels	362/150
4	Pin punches/2x115-3x125-4x145-5x165	367
1	Centre punches	368/4x125
1	Mallets	376/35
1	Hammers for mechanics with graphite handle	382 F/500
1	Plastic tray (empty)	519/382FV

LxPxH mm	Kg	code	
415x188x45	1,7	U05190742	1



### 519/382FA

Assortment in plastic tray (8 pcs)

pcs	description	item/size
1	Chisels	362/150
4	Pin punches/2x115-3x125-4x145-5x165	367
1	Centre punches	368/4x125
1	Mallets with graphite handle	376 F/32
1	Hammers for mechanics with graphite handle	382 F/500
1	Plastic tray (empty)	519/382FAV

LxPxH mm	Kg	code	
415x188x45	1,7	U05190828	1

### 519/382FAV

Plastic tray (empty)

- For assortment 519/382FA

LxPxH mm	code	
415x188x45	U05190174Q	1



1/4 1/2

### 519/607ACEA

Assortment in plastic tray (56 pcs.)

pcs	description	item/size
16	Hexagonal sockets /10-11-12-13-14-15-16-17-18-19-21-22-24-27-30-32	235 1/2 EN
10	Hexagonal sockets / 5,5-6-7-8-9-10-11-12-13-14	235 1/4 EN
1	Extensions	236 1/2/125
2	Extensions/50-100	236 1/4
1	Reversible ratchet with sealed mechanism (certified IP51)	237 A 1/2
1	Reversible ratchet with sealed mechanism (certified IP51)	237 A 1/4
1	Universal joint	241 1/2
1	Universal joint	241 1/4
1	Spinner with handle	243 1/4
3	Bits for slot-head screws -1/4" / 0,8x5,5-1x5,5-1,2x6,5	660
5	Bits for hex socket screws -1/4" / 3-4-5-6-8	660 E
3	Bits for PHILLIPS® screws -1/4"/1-2-3	660 PH
3	Bits for POZIDRIV® - SUPADRIV® screws -1/4"/1-2-3	660 PZ
7	Bits for TORX® Tamper Resistant screws -1/4" /T10-T15-T20-T25-T27-T30-T40	660 STX
1	Bit-holder sockets	684/1/4
1	Plastic tray (empty)	519/607ACEV

LxPxH mm	Kg	code	
415x188x45	3	U05190839	1



1/4 1/2

### 519/607ACEB

Assortment in plastic tray (56 pcs.)

pcs	description	item/size
16	Hexagonal sockets /10-11-12-13-14-15-16-17-18-19-21-22-24-27-30-32	235 1/2 EN
10	Hexagonal sockets /5,5-6-7-8-9-10-11-12-13-14	235 1/4 EN
1	Extensions	236 1/2/125
2	Extensions/50-100	236 1/4
1	Reversible ratchet with sealed mechanism	237 B 1/2
1	Reversible ratchet with sealed mechanism	237 B 1/4
1	Universal joint	241 1/2
1	Universal joint	241 1/4
1	Spinner with handle	243 1/4
3	Bits for slot-head screws -1/4" / 0,8x5,5-1x5,5-1,2x6,5	660
5	Bits for hex socket screws -1/4" / 3-4-5-6-8	660 E
3	Bits for PHILLIPS® screws -1/4" / 1-2-3	660 PH
3	Bits for POZIDRIV® - SUPADRIV® screws -1/4"/1-2-3	660 PZ
7	Bits for TORX® Tamper Resistant screws -1/4" /T10-T15-T20-T25-T27-T30-T40	660 STX
1	Bit-holder sockets	684/1/4
1	Plastic tray (empty)	519/607ACEV

LxPxH mm	Kg	code	
415x188x45	3	U05190840	1

## 519/607ACEV

### Plastic tray (empty)



- For assortment 519/607ACEA, 519/607ACB

LxPxH mm	code	
415x188x45	U05190839Q	1



1/4

## 519/607AEA

### Assortment in plastic tray (44 pcs.)



pcs	description	item/size
10	Long hexagonal sockets / 5-6-7-8-9-10-11-12-13-14	235 1/4 EL
13	Hexagonal sockets / 4-4,5-5-5,5-6-7-8-9-10-11-12-13-14	235 1/4 EN
3	Extensions/50-100-150	236 1/4
1	Flexible extension	236 1/4 SN
1	Reversible ratchet with sealed mechanism (certified IP51)	237 A 1/4
1	T-handle with sliding square drive	240 1/4
1	Universal joint	241 1/4
1	Spinner with handle	243 1/4
4	Bits for slot-head screws -1/4" / 0,6x4,5-0,8x5,5-1x5,5-1,2x6,5	660
5	Bits for hex socket screws -1/4" / 2,5-3-4-5-6	660 E
3	Bits for PHILLIPS® screws -1/4"/1-2-3	660 PH
1	Bit-holder sockets	684/1/4
1	Plastic tray (empty)	519/607AV

LxPxH mm	kg	code	
415x188x45	1,2	U05190790	1



1/4

## 519/607AEB

### Assortment in plastic tray (44 pcs.)



pcs	description	item/size
10	Long hexagonal sockets / 5-6-7-8-9-10-11-12-13-14	235 1/4 EL
13	Hexagonal sockets /4-4,5-5-5,5-6-7-8-9-10-11-12-13-14	235 1/4 EN
3	Extensions/50-100-150	236 1/4
1	Flexible extension	236 1/4 SN
1	Reversible ratchet with sealed mechanism	237 B 1/4
1	T-handle with sliding square drive	240 1/4
1	Universal joint	241 1/4
1	Spinner with handle	243 1/4
4	Bits for slot-head screws -1/4" / 0,6x4,5-0,8x5,5-1x5,5-1,2x6,5	660
5	Bits for hex socket screws -1/4" / 2,5-3-4-5-6	660 E
3	Bits for PHILLIPS® screws -1/4"/1-2-3	660 PH
1	Bit-holder sockets	684/1/4
1	Plastic tray (empty)	519/607AV

LxPxH mm	kg	code	
415x188x45	1,2	U05190791	1

## 519/607AV

### Plastic tray (empty)



- For assortment 519/607AEA, 519/607AEB

LxPxH mm	code	
415x188x45	U05190353Q	1



1/2

## 519/607CA

### Assortment in plastic tray (25 pcs.)



pcs	description	item/size
19	Bihexagonal sockets /8-9-10-11-12-13-14-15-16-17-18-19-21-22-23-24-27-30-32	235 1/2 N
2	Extensions/125-250	236 1/2
1	Reversible ratchet with sealed mechanism (certified IP51)	237 A 1/2
1	Speed brace with revolving handle	239 1/2 N
1	T-handle with sliding square drive	240 1/2 N
1	Universal joint	241 1/2
1	Plastic tray (empty)	519/607CV

LxPxH mm	kg	code	
415x188x45	4,7	U05190810	1



1/2

## 519/607CB

### Assortment in plastic tray (25 pcs.)



pcs	description	item/size
19	Bihexagonal sockets / 8-9-10-11-12-13-14-15-16-17-18-19-21-22-23-24-27-30-32	235 1/2 N
2	Extensions/125-250	236 1/2
1	Reversible ratchet with sealed mechanism	237 B 1/2
1	Speed brace with revolving handle	239 1/2 N
1	T-handle with sliding square drive	240 1/2 N
1	Universal joint	241 1/2
1	Plastic tray (empty)	519/607CV

LxPxH mm	kg	code	
415x188x45	4,8	U05190812	1

## 519/607CV

### Plastic tray (empty)

- For assortment 519/607CA, 519/607CB

LxPxH mm	code	
415x188x45	U05190352Q	1



1/2

## 519/607CEA

### Assortment in plastic tray (30 pcs.)



pcs	description	item/size
24	Hexagonal sockets /8-9-10-11-12-13-14-15-16-17-18-19-20-21-22-23-24-26-27-28-29-30-32-34	235 1/2 EN
2	Extensions/125-250	236 1/2
1	Reversible ratchet with sealed mechanism (certified IP51)	237 A 1/2
1	Speed brace with revolving handle	239 1/2 N
1	T-handle with sliding square drive	240 1/2 N
1	Universal joint	241 1/2
1	Plastic tray (empty)	519/607CV

LxPxH mm	kg	code	
415x188x45	4,8	U05190811	1



1/2

## 519/607CEB

### Assortment in plastic tray (30 pcs.)



pcs	description	item/size
24	Hexagonal sockets /8-9-10-11-12-13-14-15-16-17-18-19-20-21-22-23-24-26-27-28-29-30-32-34	235 1/2 EN
2	Extensions/125-250	236 1/2
1	Reversible ratchet with sealed mechanism	237 B 1/2
1	Speed brace with revolving handle	239 1/2 N
1	T-handle with sliding square drive	240 1/2 N
1	Universal joint	241 1/2
1	Plastic tray (empty)	519/607CV

LxPxH mm	kg	code	
415x188x45	4,9	U05190813	1

## 519/607C1V

### Plastic tray (empty)

- For assortment 519/607CEA and 519/607CEB

LxPxH mm	code	
415x188x45	U05190356Q	1





1/2

### 519/607ICEA

Assortment in plastic tray (49 pcs.)

pcs	description	item/size
18	Hexagonal sockets /8-10-11-12-13-14-15-16-17-18-19-21-22-23-24-27-30-32	235 1/2 EN
2	Extensions/125-250	236 1/2
1	Reversible ratchet with sealed mechanism (certified IP51)	237 A 1/2
1	T-handle with sliding square drive	240 1/2 N
1	Universal joint	241 1/2
4	Bits for slot-head screws - 5/16" / 0,8x5,5-1x6,5-1,2x8-1,6x10	661
4	Bits for hex socket screws - 5/16" / 5-6-8-10	661 E
3	Bits for PHILLIPS® screws - 5/16" / 1-2-3	661 PH
3	Bits for POZIDRIV®-SUPADRIV® screws - 5/16" / 1-2-3	661 PZ
6	Bits for TORX® screws - 5/16" / T27-T30-T40-T45-T50-T55	661 TX
5	Bits for hex socket screws - 1/4" / 5-6-7-8-10	664 EL
1	Bit-holder sockets	684/1/2
1	Plastic tray (empty)	519/607ICEV

LxPxH mm	kg	code	
415x188x45	3,4	U05190841	1



1/2

### 519/607ICEB

Assortment in plastic tray (49 pcs.)

pcs	description	item/size
18	Hexagonal sockets / 8-10-11-12-13-14-15-16-17-18-19-21-22-23-24-27-30-32	235 1/2 EN
2	Extensions/125-250	236 1/2
1	Reversible ratchet with sealed mechanism	237 B 1/2
1	T-handle with sliding square drive	240 1/2 N
1	Universal joint	241 1/2
4	Bits for slot-head screws - 5/16" / 0,8x5,5-1x6,5-1,2x8-1,6x10	661
4	Bits for hex socket screws - 5/16" / 5-6-8-10	661 E
3	Bits for PHILLIPS® screws - 5/16" / 1-2-3	661 PH
3	Bits for POZIDRIV®-SUPADRIV® screws - 5/16" / 1-2-3	661 PZ
6	Bits for TORX® screws - 5/16" / T27-T30-T40-T45-T50-T55	661 TX
5	Bits for hex socket screws - 1/4" / 5-6-7-8-10	664 EL
1	Bit-holder sockets	684/1/2
1	Plastic tray (empty)	519/607ICEV

LxPxH mm	kg	code	
415x188x45	3,5	U05190842	1

### 519/607ICEV Plastic tray (empty)

- For assortment 519/607ICEA, 519/607ICEB

LxPxH mm	code	
415x188x45	U05190841Q	1



1/4

### 519/613AEA

Assortment in plastic tray (42 pcs.)

pcs	description	item/size
13	Hexagonal sockets / 4-4,5-5-5,5-6-7-8-9-10-11-12-13-14	235 1/4 EN
2	Extensions/50-150	236 1/4
1	Reversible ratchet with sealed mechanism (certified IP51)	237 A 1/4
1	T-handle with sliding square drive	240 1/4
1	Universal joint	241 1/4/40
1	Spinner with handle	243 1/4
1	Bit-holder sockets	684/1/4
11	Assortment in plastic box - 1/4" (11 pcs.)	692 S11
11	Assortment in plastic box - 1/4" (11 pcs.)	692 STX/S11
1	Plastic tray (empty)	519/613AEV

LxPxH mm	kg	code	
415x188x45	900	U05190784	1



1/4

### 519/613AEB

Assortment in plastic tray (42 pcs.)

pcs	description	item/size
13	Hexagonal sockets / 4-4,5-5-5,5-6-7-8-9-10-11-12-13-14	235 1/4 EN
2	Extensions/50-150	236 1/4
1	Reversible ratchet with sealed mechanism	237 B 1/4
1	T-handle with sliding square drive	240 1/4
1	Universal joint/40 mm	241 1/4
1	Spinner with handle	243 1/4
1	Bit-holder sockets	684/1/4
11	Assortment in plastic box - 1/4" (11 pcs.)	692 S11
11	Assortment in plastic box - 1/4" (11 pcs.)	692 STX/S11
1	Plastic tray (empty)	519/613AEV

LxPxH mm	kg	code	
415x188x45	900	U05190778	1

### 519/613AEV Plastic tray (empty)

- For assortment 519/613AEA, 519/613AEB

LxPxH mm	code	
415x188x45	U05190345Q	1



3/8

### 519/613BA

Assortment in plastic tray (21 pcs.)

pcs	description	item/size
16	Bihexagonal sockets /6-7-8-9-10-11-12-13-14-15-16-17-18-19-21-22	235 3/8
2	Extensions/125-250	236 3/8
1	Reversible ratchet with sealed mechanism (certified IP51)	237 A 3/8
1	T-handle with sliding square drive	240 3/8 N
1	Universal joint	241 3/8
1	Plastic tray (empty)	519/613BEV

LxPxH mm	kg	code	
415x188x45	1,6	U05190789	1



3/8

### 519/613BB

Assortment in plastic tray (21 pcs.)

pcs	description	item/size
16	Bihexagonal sockets / 6-7-8-9-10-11-12-13-14-15-16-17-18-19-21-22	235 3/8
2	Extensions/125-250	236 3/8
1	Reversible ratchet with sealed mechanism	237 B 3/8
1	T-handle with sliding square drive	240 3/8 N
1	Universal joint	241 3/8
1	Plastic tray (empty)	519/613BEV

LxPxH mm	kg	code	
415x188x45	1,7	U05190792	1



3/8

### 519/613BEA

Assortment in plastic tray (21 pcs.)

pcs	description	item/size
16	Hexagonal sockets /6-7-8-9-10-11-12-13-14-15-16-17-18-19-21-22	235 3/8 E
2	Extensions/125-250	236 3/8
1	Reversible ratchet with sealed mechanism (certified IP51)	237 A 3/8
1	T-handle with sliding square drive	240 3/8 N
1	Universal joint	241 3/8
1	Plastic tray (empty)	519/613BEV

LxPxH mm	kg	code	
415x188x45	1,6	U05190747	1





3/8

### 519/613BEB

Assortment in plastic tray (21 pcs.)

pcs	description	item/size
16	Hexagonal sockets / 6-7-8-9-10-11-12-13-14-15-16-17-18-19-21-22	235 3/8 E
2	Extensions/125-250	236 3/8
1	Reversible ratchet with sealed mechanism	237 B 3/8
1	T-handle with sliding square drive	240 3/8 N
1	Universal joint	241 3/8
1	Plastic tray (empty)	519/613BEBV

LxPxH mm	kg	code	
415x188x45	1,7	U05190779	1

### 519/613BEBV

Plastic tray (empty)

- For assortment 519/606BA, 519/606BB, 519/613BEA, 519/613BEB

LxPxH mm	code	
415x188x45	U05190346Q	1



1/2

### 519/613CEA

Assortment in plastic tray (22 pcs.)

pcs	description	item/size
17	Hexagonal sockets / 10-11-12-13-14-15-16-17-18-19-20-21-22-24-27-30-32	235 1/2 EN
2	Extensions/125-250	236 1/2
1	Reversible ratchet with sealed mechanism (certified IP51)	237 A 1/2
1	T-handle with sliding square drive	240 1/2 N
1	Universal joint	241 1/2
1	Plastic tray (empty)	519/613CEBV

LxPxH mm	kg	code	
415x188x45	3,4	U05190750	1



1/2

### 519/613CEB

Assortment in plastic tray (22 pcs.)

pcs	description	item/size
17	Hexagonal sockets / 10-11-12-13-14-15-16-17-18-19-20-21-22-24-27-30-32	235 1/2 EN
2	Extensions/125-250	236 1/2
1	Reversible ratchet with sealed mechanism	237 B 1/2
1	T-handle with sliding square drive	240 1/2 N
1	Universal joint	241 1/2
1	Plastic tray (empty)	519/613CEBV

LxPxH mm	kg	code	
415x188x45	3,4	U05190780	1



1/2

### 519/613CB

Assortment in plastic tray (22 pcs.)

pcs	description	item/size
17	Bihexagonal sockets / 10-11-12-13-14-15-16-17-18-19-20-21-22-24-27-30-32	235 1/2 N
2	Extensions /125-250	236 1/2
1	Reversible ratchet with sealed mechanism	237 B 1/2
1	T-handle with sliding square drive	240 1/2 N
1	Universal joint	241 1/2
1	Plastic tray (empty)	519/613CEBV

LxPxH mm	kg	code	
415x188x45	3,3	U05190783	1

### 519/613CEBV

Plastic tray (empty)

- For assortment 519/613CEA, 519/613CEB, 519/613CB

LxPxH mm	code	
415x188x45	U05190347Q	1



1/4

### 519/615AEA

Assortment in plastic tray (52 pcs.)

pcs	description	item/size
10	Hexagonal sockets / 5,5-6-7-8-9-10-11-12-13-14	235 1/4 EN
2	Extensions/50-150	236 1/4
1	Reversible ratchet with sealed mechanism (certified IP51)	237 A 1/4
1	T-handle with sliding square drive	240 1/4
1	Universal joint	241 1/4
1	Spinner with handle	243 1/4
9	Set of 9 long angled hexagon keys with spherical head /1,5-2-2,5-3-4-5-6-8-10	280 LTS/S9
8	Set of 8 long angled keys with spherical head for TORX® screws /T10-T15-T20-T25-T27-T30-T40-T45	280 LTSTX/S8
2	Bits for slot-head screws -1/4" / 0,5x4-1x5,5	660
5	Bits for hex socket screws -1/4" / 3-4-5-6-8	660 E
3	Bits for PHILLIPS® screws -1/4" / 1-2-3	660 PH
2	Bits for POZIDRIV® - SUPADRIV® screws -1/4" / 1-2	660 PZ
6	Bits for TORX® Tamper Resistant screws -1/4" / T10-T15-T20-T25-T30-T40	660 STX
1	Bit-holder sockets	684/1/4
1	Plastic tray (empty)	519/615AEV

LxPxH mm	kg	code	
415x188x45	1,4	U05190837	1



1/4

### 519/615AEB

Assortment in plastic tray (52 pcs.)

pcs	description	item/size
10	Hexagonal sockets / 5,5-6-7-8-9-10-11-12-13-14	235 1/4 EN
2	Extensions/50-150	236 1/4
1	Reversible ratchet with sealed mechanism	237 B 1/4
1	T-handle with sliding square drive	240 1/4
1	Universal joint	241 1/4
1	Spinner with handle	243 1/4
9	Set of 9 long angled hexagon keys with spherical head/1,5-2-2,5-3-4-5-6-8-10	280 LTS/S9
8	Set of 8 long angled keys with spherical head for TORX® screws /T10-T15-T20-T25-T27-T30-T40-T45	280 LTSTX/S8
2	Bits for slot-head screws -1/4" / 0,5x4-1x5,5	660
5	Bits for hex socket screws -1/4" / 3-4-5-6-8	660 E
3	Bits for PHILLIPS® screws -1/4" / 1-2-3	660 PH
2	Bits for POZIDRIV® - SUPADRIV® screws -1/4" / 1-2	660 PZ
6	Bits for TORX® Tamper Resistant screws -1/4" / T10-T15-T20-T25-T30-T40	660 STX
1	Bit-holder sockets	684/1/4
1	Plastic tray (empty)	519/615AEV

LxPxH mm	kg	code	
415x188x45	1,4	U05190838	1

## 519/615AEV

### Plastic tray (empty)

- For assortment 519/615AE, 519/615AEB



LxPxH mm	code	
415x188x45	U05190837Q	1



## 519/960

### Assortment in plastic tray (7 pcs.)



pcs	description	item/size
1	Scissors for electricians	207 A
1	Utility knife with snap-off blades	220 B1
1	Vernier caliper to 1/20 mm	960
1	Thickness gauges	966/20
1	Scriber	974
1	Flexible graduated rules	978 A/200
1	Professional tape rules with shockproof covering	981 A/3
1	Plastic tray (empty)	519/960V

LxPxH mm	gr	code	
415x188x45	800	U05190753	1



## 519/990A1

### Assortment in plastic tray (4 pcs.)

- Second cut



pcs	description	item/size
1	Flat square file	990 M PA/200
1	Half-round file	990 M PB/200
1	Round file	990 M PC/200
1	Triangular file	990 M PE/200
1	Plastic tray (empty)	519/990AB1V

LxPxH mm	gr	code	
415x188x45	800	U05190825	1



## 519/990AB1

### Assortment in plastic tray (4 pcs.)

- Bastard cut



pcs	description	item/size
1	Flat square file	990 B PA/200
1	Half-round file	990 B PB/200
1	Round file	990 B PC/200
1	Triangular file	990 B PE/200
1	Plastic tray (empty)	519/990AB1V

LxPxH mm	gr	code	
415x188x45	800	U05190826	1

## 519/990AB1V

### Plastic tray (empty)

- For assortment 519/990A1, 519/990AB1



LxPxH mm	code	
415x188x45	U05190825Q	1



## 519/280T

### Assortment in plastic tray (8 pcs.)



pcs	description	item/size
8	T-handle hexagon keys / 2-2,5-3-4-5-6-8-10	280 T
1	Plastic tray (empty)	519/280TV

LxPxH mm	code	
415x376x45	U05190727	1

## 519/280TV

### Plastic tray (empty)

- For assortment 519/280T



LxPxH mm	code	
415x376x45	U05190326Q	1



## 519/200I

### Assortment in plastic tray (11 pcs.)



pcs	description	item/size
1	Hacksaw	200 S
1	Scissors for electricians	207 A
2	Chisels	362/125-150
1	Cross cut chisel	364/125
2	Drift punches/4x150-3x125	366
1	Centre punches	368/4x125
1	Mallets	376/35
1	Hammers for mechanics	382/500
1	Thickness gauges	966/20
1	Plastic tray (empty)	519/200IV

LxPxH mm	code	
415x565x45	U05190715	1

## 519/200IV

### Plastic tray (empty)

- For assortment 519/200I



LxPxH mm	code	
415x565x45	U05190322Q	1



## 519/276

### Assortment in plastic tray (8 pcs.)



pcs	description	item/size
8	T-handle wrenches with jointed hexagonal socket/7-8-10-11-13-14-17-19	276 CE
1	Plastic tray (empty)	519/276V

LxPxH mm	code	
415x565x45	U05190725	1

## 519/276V

### Plastic tray (empty)

- For assortment 519/276



LxPxH mm	code	
415x565x45	U05190323Q	1

### BI-COLOUR FOAM MODULES



1/2

## 519 M 233MNTXC6

### Bi-colour foam module with assortment (6 pcs.)



pcs	description	item/size
6	Long impact socket bits for TORX® screws / 233 1/2 MNTX T30-T40-T45-T50-T55-T60	
1	Empty bi-colour foam module	519 M 233MNTXC6V

LxPxH mm	code	
104x188x45	U05191024	1

## 519 M 233MNTXC6V

### Empty bi-colour foam module

- For assortment 519 M 233MNTXC6



LxPxH mm	code	
104x188x45	U05191024Q	1

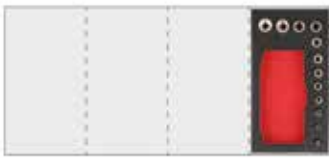

1/4

### 519 M 235AP

Bi-colour foam module with assortment (12 pcs.)

pcs	description	item/size
12	Hexagonal sockets, inch sizes 1/8-5/32-3/16-7/32-1/4-9/32-5/16-11/32-3/8-7/16-1/2-9/16	235 1/4 EPN
1	Bi-colour foam module (empty)	519 M 235APV

LxPxH mm	g	code	
104x188x45	200	U05190970	1

### 519 M 235APV

Bi-colour foam module (empty)

- For assortment 519 M 235AP

LxPxH mm	code	
104x188x45	U05190970Q	1

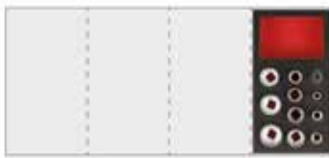

3/8

### 519 M 235BP

Bi-colour foam module with assortment (11 pcs.)

pcs	description	item/size
11	Bihexagonal sockets/ 1/4-5/16-3/8-7/16-1/2-9/16-5/8-11/16-3/4-13/16-7/8	235 3/8 P
1	Bi-colour foam module (empty)	519 M 235BPV

LxPxH mm	g	code	
104x188x45	500	U05190971	1

### 519 M 235BPV

Bi-colour foam module (empty)

- For assortment 519 M 235BP

LxPxH mm	code	
108x104x45	U05190971Q	1



1/2

### 519 M 235M2

Bi-colour foam module with assortment (5 pcs.)

pcs	description	item/size
5	Impact sockets for tyre rims with teflon protection/15-17-19-21-22	270 C
1	Bi-colour foam module (empty)	519 M 235M2V

LxPxH mm	Kg	code	
104x188x45	1,1	U05191035	1

### 519 M 235M2V

Bi-colour foam module (empty)

- For assortment 519 M 235M2

LxPxH mm	code	
104x188x45	U05191035Q	1



1/2

### 519 M 235MC7

Bi-colour foam module with assortment (7 pcs.)

pcs	description	item/size
7	Impact hexagonal sockets/10-13-14-17-19-22-24	235 1/2 M
1	Empty bi-colour foam module	519 M 235MC7V

LxPxH mm	g	code	
104x188x45	730	U05191026	1

### 519 M 235MC7V

Empty bi-colour foam module

- For assortment 519 M 235MC7

LxPxH mm	code	
104x188x45	U05191026Q	1



### 519 M 458S20

Bi-colour foam module with assortment (20 pcs.)

pcs	description	item/size
11	Pullers for damaged nuts and screws / 8-10-11-12-13-14-15-16-17-18-19	458 B
8	Set of grip bits for damaged hexagonal screws (9 pcs.)/2-2,5-3-4-5-6-7-8	458 E/B9
1	Bit-holder sockets	684 1/4
1	Empty bi-colour foam module	519 M 458S20V

LxPxH mm	g	code	
104x188x45	670	U05191033	1

### 519 M 458S20V

Empty bi-colour foam module

- For assortment 519 M 458S20

LxPxH mm	code	
104x188x45	U05191033Q	1

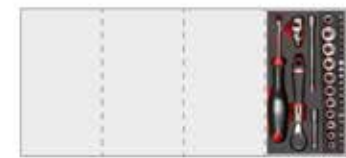

### 519 M 608AEA

Bi-colour foam module with assortment (37 pcs.)

pcs	description	item/size
10	Hexagonal sockets /5,5-6-7-8-9-10-11-12-13-14	235 1/4 EN
2	Extensions/50-100	236 1/4
1	Reversible ratchet with sealed mechanism (certified IP51)	237 A 1/4
1	Universal joint	241 1/4
1	Spinner with handle	243 1/4
3	Bits for slot-head screws -1/4" / 0,6x4,5-0,8x5,5-1x5,5	660
5	Bits for hex socket screws -1/4" / 2,5-3-4-5-6	660 E
3	Bits for PHILLIPS® screws -1/4"/ 1-2-3	660 PH
3	Bits for POZIDRIV® - SUPADRIV® screws -1/4" / 1-2-3	660 PZ/1-2-3
7	Bits for TORX® Tamper Resistant screws -1/4" /T10-T15-T20-T25-T27-T30-T40	660 STX
1	Bit-holder sockets	684/1/4
1	Empty bi-colour foam module	519 M 608AEA V

LxPxH mm	g	code	
104x188x45	500	U05190966	1

## CREATE YOUR IDEAL ASSORTMENT!

Go to [kitplanner-gb.usag.it](http://kitplanner-gb.usag.it) or frame the QR code



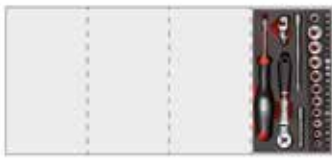

1/4

### 519 M 608AEB



#### Bi-colour foam module with assortment (37 pcs.)

pcs	description	item/size
10	Hexagonal sockets / 5,5-6-7-8-9-10-11-12-13-14	235 1/4 EN
2	Extensions/50-100	236 1/4
1	Reversible ratchet with sealed mechanism	237 B 1/4
1	Universal joint	241 1/4
1	Spinner with handle	243 1/4
3	Bits for slot-head screws -1/4" / 0,6x4,5-0,8x5,5-1x5,5	660
5	Bits for hex socket screws -1/4" / 2,5-3-4-5-6	660 E
3	Bits for PHILLIPS® screws -1/4" / 1-2-3	660 PH
3	Bits for POZIDRIV® - SUPADRIV® screws -1/4" / 1-2-3	660 PZ
7	Bits for TORX® Tamper Resistant screws -1/4" / T10-T15-T20-T25-T27-T30-T40	660 STX
1	Bit-holder sockets	684/1/4
1	Bi-colour foam module (empty)	519 M 608AEEAV

LxPxH mm	kg	code	
104x188x45	500	U05190968	1

### 519 M 608AEEAV

#### Bi-colour foam module (empty)

- For assortments 519 M 608AEA and 519 M 608AEB

LxPxH mm	code	
104x188x45	U05191050Q	1



3/4

### 519 M 688ED6



#### Bi-colour foam module with assortment (6 pcs.)

pcs	description	item/size
1	Holder for impact bits	685 B/3/4-7/8
5	Impact bits for hexagonal screws - 7/8" connection/12-17-19-22-24	688 E
1	Empty bi-colour foam module	519 M 688ED6V

LxPxH mm	kg	code	
104x188x45	1,2	U05191030	1

### 519 M 688ED6V

#### Empty bi-colour foam module

- For assortment 519 M 688ED6

LxPxH mm	code	
104x188x45	U05191030Q	1



1/2

### 519 M 811G



#### Bi-colour foam module with assortment (5 pcs.)

- Can be inserted in the compartments of the foam module 519 M 811ND

pcs	description	item/size
5	Open jaw wrenches /13-17-19-22-24	811 G
1	Bi-colour foam module (empty)	519 M 811GV

LxPxH mm	kg	code	
104x188x45	700	U05190996	1

### 519 M 811GV

#### Bi-colour foam module (empty)

- For assortment 519 M 811G  
- Can be inserted in the compartments of the foam module 519 M 811ND

LxPxH mm	code	
104x188x45	U05190996Q	1

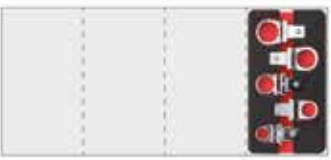

### 519 M 811K

#### Bi-colour foam module with assortment (5 pcs.)

- Can be inserted in the compartments of the foam module 519 M 811ND

pcs	description	item/size
5	Bihexagonal ring wrenches/13-17-19-22-24	811 K
1	Bi-colour foam module (empty)	519 M 811KV

LxPxH mm	kg	code	
104x188x45	700	U05190997	1

### 519 M 811KV

#### Bi-colour foam module (empty)

- For assortment 519 M 811K  
- Can be inserted in the compartments of the foam module 519 M 811ND

LxPxH mm	code	
104x188x45	U05190997Q	1



### 519 MSK

#### Foam module for small parts (empty)

LxPxH mm	kg	code	
104x188x45	50	U05190973	1



1/2

### 519 M 234MNC8



#### Bi-colour foam module with assortment (8 pcs.)

pcs	description	item/size
8	Impact socket bits for hex socket screws /5-6-8-10-12-14-17-19	234 1/2 MN
1	Empty bi-colour foam module	519 M 234MNC8V

LxPxH mm	kg	code	
311x188x45	1,1	U05191025	1

### 519 M 234MNC8V

#### Empty bi-colour foam module

- For assortment 519 M 234MNC8

LxPxH mm	code	
311x188x45	U05191025Q	1



3/4

### 519 M 235MD7



#### Bi-colour foam module with assortment (7 pcs.)

pcs	description	item/size
7	Impact hexagonal sockets / 17-19-22-24-27-30-32	235 3/4 M
1	Bi-colour foam module (empty)	519 M 235MD7V

LxPxH mm	kg	code	
311x188x45	2,3	U05191028	1

### 519 M 235MD7V

#### Bi-colour foam module (empty)

- For assortment 519 M 235MD7

LxPxH mm	code	
311x188x45	U05191028Q	1



### 519 M 272DS

#### Bi-colour foam module with assortment (10 pcs.)

- For locking wheel nuts and screws

pcs	description	item/size
1	Impact sockets for tyre rims with teflon protection	270 C/17
3	Conical sockets to center/extract (3 pcs.) /19-21,8-25	272 CS
2	Extractors with hexagonal drive (2 pcs.)	272 EX
2	Special tungsten carbide tips (2 pcs.)	272 P/8,7
2	Kit with special handle and socket for removing the extractor	272 PH
1	Bi-colour foam module (empty)	519 M 272DSV

LxPxH mm	kg	code	
311x188x45	2,7	U05191032	1

## 519 M 272DSV

### Bi-colour foam module (empty)

- For assortment 519 M 272DS



LxPxH mm	code	
311x188x45	U05191032Q	1



## 519 M 282S10

### Bi-colour foam module with assortment (10 pcs.)

pcs	description	item/size
1	Adjustable pin-type face wrenches with round pins	281 DT
1	Adjustable pin-type face wrenches with square pins	281 DQ
4	Round pins	
4	Square pins	
1	Bi-colour foam module (empty)	519 M 282S10V

LxPxH mm	code	
311x188x45	U05191054	1

## 519 M 282S10V

### Bi-colour foam module (empty)

- For assortment 519 M 282S10



LxPxH mm	code	
311x188x45	U05191054Q	1



## 519 M 612S13

### Bi-colour foam module with assortment (13 pcs.)

pcs	description	item/size
2	Extensions/125-250	236 3/8
1	T-handle with sliding square drive	240 3/8 N
1	Universal joint	241 3/8
9	Crow-foot wrenches / 10-11-12-13-14-17-19-22-24	257 3/8
1	Bi-colour foam module (empty)	519 M 612S13V

LxPxH mm	Kg	code	
311x188x45	1,1	U05190985	1

## 519 M 612S13V

### Bi-colour foam module (empty)

- For assortment 519 M 612S13



LxPxH mm	code	
311x188x45	U05190985Q	1



## 1000 V

### 519 M 085EX

### Bi-colour foam module with assortment (5 pcs.)

pcs	description	item/size
1	Half-round extra-long nose pliers with straight jaws - 1000 V	081 EX/160
1	Combination pliers - 1000 V	085 EX/180
1	Diagonal cutting nippers - 1000 V	087 EX/160
1	Lock-grip pliers with concave jaws	134/250
1	Box-joint adjustable pliers	180 C/250

LxPxH mm	Kg	code	
415x188x45	1,6	U05191010	1



## 1000 V

### 519 M 085EX1

### Bi-colour foam module with assortment (4 pcs.)

pcs	description	item/size
1	Half-round extra-long nose pliers with straight jaws - 1000 V	081 EX/160
1	Combination pliers - 1000 V	085 EX/180
1	Diagonal cutting nippers - 1000 V	087 EX/160
1	Professional scissors for electricians	207 E
1	Bi-colour foam module (empty)	519 M 085EX1V

LxPxH mm	Kg	code	
415x188x45	1	U05191019	1

## 519 M 085EX1V

### Bi-colour foam module (empty)

- For assortment 519 M 085EX1



LxPxH mm	code	
415x188x45	U05191019Q	1



## 1000 V

### 519 M 091A

### Bi-colour foam module with assortment (8 pcs.)

pcs	description	item/size
4	Screwdrivers for slot-head screws - 1000 V / 0,5x3x75-0,8x4x100-1x5,5x125-1,2x6,5x150	091
2	Screwdrivers for PHILLIPS® screws - 1000 V / 1x100-2x125	091 PH
2	Screwdrivers for POZIDRIV® - SUPADRIV® screws - 1000 V / 1x100-2x125	091 PZ
1	Bi-colour foam module (empty)	519 M 091AV

LxPxH mm	gr	code	
415x188x45	900	U05191016	1

## 519 M 091AV

### Bi-colour foam module (empty)

- For assortment 519 M 091A



LxPxH mm	code	
415x188x45	U05191016Q	1

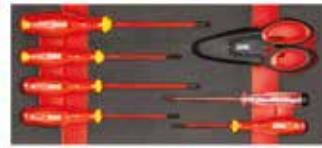

## 1000 V

### 519 M 091B

### Bi-colour foam module with assortment (7 pcs.)

pcs	description	item/size
3	Screwdrivers for slot-head screws - 1000 V 091 / 0,6x3,5x100-0,8x4x100-1x5,5x125	091 PH
2	Screwdrivers for PHILLIPS® screws - 1000 V / 1x100-2x125	
1	Professional scissors for electricians	207 E
1	Phase-testing screwdriver 90-480V, long model/90-480	321 FL
1	Bi-colour foam module (empty)	519 M 091BV

LxPxH mm	gr	code	
415x188x45	784	U05191018	1

## 519 M 091BV

### Bi-colour foam module (empty)

- For assortment 519 M 091B



LxPxH mm	code	
415x188x45	U05191018Q	1



3/8

## 1000 V

### 519 M 098HYB8

### Bi-colour foam module with assortment (8 pcs.)

- For securing hybrid and electric cars

pcs	description	item/size
1	Half-round extra-long nose pliers with straight jaws - 1000 V	081 EX/200
1	Screwdrivers for slot-head screws - 1000 V 091/1x5,5x125	
1	Screwdrivers for PHILLIPS® screws - 1000 V	091 PH/2x125
3	Bihexagonal sockets - 1000 V / 8-10-12	098 3/8
1	Reversible ratchet 3/8" - 1000 V	098 A 3/8
1	Extensions 3/8" - 1000 V	098 B 3/8/150
1	Bi-colour foam module (empty)	519 M 098HYB8V

LxPxH mm	Kg	code	
415x188x45	1,3	U05191031	1

## 519 M 098HYB8V

### Bi-colour foam module (empty)

- For assortment 519 M 098HYB8



LxPxH mm	code	
415x188x45	U05191031Q	1

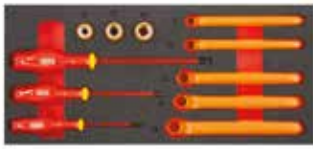

3/8



1000 V

519 M 098HYB11



**Bi-colour foam module with assortment (11 pcs.)**

- For maintenance of hybrid and electric car battery cells  
- For use in combination with the module 519 M 098HYB8

pcs	description	item/size
3	Screwdrivers for slot-head screws - 1000 V 091 /0,5x3x75-0,8x4x100-1,2x6,5x150	
3	Bi-hexagonal sockets - 1000 V / 11-13-14	098 3/8
5	Offset bi-hexagonal ring wrenches - 1000 V/8-10-12-13-14	099 B
1	Bi-colour foam module (empty)	519 M 098HYB11V

LxPxH mm	kg	code	
415x188x45	1,1	U05190155	1

**519 M 098HYB11V**

**Bi-colour foam module (empty)**

- For assortment 519 M 098HYB11



LxPxH mm	code	
415x188x45	U05190155Q	1



**519 M 127C**



**Bi-colour foam module with assortment (6 pcs.)**

pcs	description	item/size
2	Pliers with straight nose for internal circlips /12÷25-19÷60	127 C
1	Pliers with nose bent at 90° for internal circlips/15÷25	127 CP
2	Pliers with straight nose for external circlips/15÷25-19÷60	128 C
1	Pliers with nose bent at 90° for external circlips	128 CP/15÷25
1	Bi-colour foam module (empty)	519 M 127CV

LxPxH mm	kg	code	
415x188x45	1	U05191021	1

**519 M 127CV**

**Bi-colour foam module (empty)**

- For assortment 519 M 127C



LxPxH mm	code	
415x188x45	U05191021Q	1



**519 M 127N**



**Bi-colour foam module with assortment (4 pcs.)**

pcs	description	item/size
1	Pliers with straight nose for internal circlips	127 N/19÷60
1	Pliers with nose bent at 90° for internal circlips	127 PN/19÷60
1	Pliers with straight nose for external circlips	128 N/19÷60
1	Pliers with nose bent at 90° for external circlips	128 PN/19÷60
1	Bi-colour foam module (empty)	519 M 127NAV

LxPxH mm	kg	code	
415x188x45	1	U05190937	1

**519 M 127NAV**

**Bi-colour foam module (empty)**

- For assortment 519 M 127N



LxPxH mm	code	
415x188x45	U05191037Q	1



**519 M 133AX**



**Bi-colour foam module with assortment (4 pcs.)**

pcs	description	item/size
1	Half-round extra-long nose pliers with straight jaws	133 AX/160
1	Lock-grip rack-type pliers with long jaws	135 B/250
1	Combination pliers	150 AX/180
1	Semiautomatic adjustable pliers	180 B/250
1	Bi-colour foam module (empty)	519 M 133AXV

LxPxH mm	kg	code	
415x188x45	1,6	U05191003	1

**519 M 133AXV**

**Bi-colour foam module (empty)**

- For assortment 519 M 133AX



LxPxH mm	code	
415x188x45	U05191003Q	1



**519 M 133AX1**



**Bi-colour foam module with assortment (4 pcs.)**

pcs	description	item/size
1	Half-round extra-long nose pliers with straight jaws	133 AX/160
1	Semiautomatic adjustable pliers	180 B/250
1	Heavy-duty diagonal cutting nippers	188 AX/160
1	Multi-purpose scissors with inclined blades	211 B
1	Bi-colour foam module (empty)	519 M 133AX1V

LxPxH mm	kg	code	
415x188x45	1	U05191004	1

**519 M 133AX1V**

**Bi-colour foam module (empty)**

- For assortment 519 M 133AX1



LxPxH mm	code	
415x188x45	U05191004Q	1



**519 M 150AX**



**Bi-colour foam module with assortment (5 pcs.)**

pcs	description	item/size
1	Half-round extra-long nose pliers with straight jaws	133 AX/160
1	Lock-grip pliers with concave jaws	134/250
1	Combination pliers	150 AX/180
1	Box-joint adjustable pliers	180 C/250
1	Heavy-duty diagonal cutting nippers	188 AX/160
1	Bi-colour foam module (empty)	519 M 150AXAV

LxPxH mm	kg	code	
415x188x45	1,5	U05190965	1

**519 M 150AXAV**

**Bi-colour foam module (empty)**

- For assortment 519 M 150AX



LxPxH mm	code	
415x188x45	U05191039Q	1

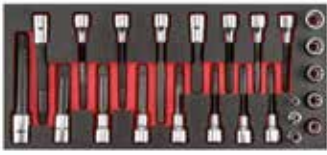

1/4 3/8 1/2

### 519 M 233C24



Bi-colour foam module with assortment (24 pcs.)

pcs	description	item/size
2	Socket bits for splined hexagonal screws (RIBE)/9L-10L	233 1/2 NS
4	Socket bits for TORX® screws / T40Lx84-T45Lx84-T55Lx104-T70Lx104	233 1/2 NTX
5	Socket bits for XZN screws /6Lx64-8Lx64-10Lx64-12Lx64-14Lx64	233 1/2 NXZN
5	Socket bits for hex socket screws / 6Lx64-7Lx64-8Lx64-10Lx104-12Lx64	234 1/2 N
5	TORX® sockets / E12-E14-E16-E18-E20	235 1/2 NTX
1	TORX® sockets	235 1/4 TX/E8
2	TORX® sockets/E8-E10	235 3/8 NTX
1	Bi-colour foam module (empty)	519 M 233C24AV

LxPxH mm	kg	code	
415x188x45	2,2	U05191002	1

### 519 M 233C24AV

Bi-colour foam module (empty)

- For assortment 519 M 233C24



LxPxH mm	code	
415x188x45	U05191038Q	1



1/2

### 519 M 235M1



Bi-colour foam module with assortment (18 pcs.)

pcs	description	item/size
12	Impact hexagonal sockets / 10-11-12-13-14-15-16-17-18-19-22-24	235 1/2 M
6	Long impact hexagonal sockets with thin walls / 15-17-19-21-22-24	235 1/2 MLS
2	Lock pins	235 MCA/4-6
2	Safety rings	235 MDA/4-6
1	Bi-colour foam module (empty)	519 M 235M1V

LxPxH mm	kg	code	
415x188x45	2,7	U05191034	1

### 519 M 235M1V

Bi-colour foam module (empty)

- For assortment 519 M 235M1



LxPxH mm	code	
415x188x45	U05191034Q	1



1/2

### 519 M 236K



Bi-colour foam module with assortment (13 pcs.)

pcs	description	item/size
12	Impact hexagonal sockets / 10-11-12-13-14-15-16-17-18-19-22-24	235 1/2 M
1	Chain extension in Aluminium for sockets	236 K 1/2
1	Bi-colour foam module (empty)	519 M 236KV

LxPxH mm	kg	code	
415x188x45	2,3	U05190236	1

### 519 M 236KV

Bi-colour foam module (empty)

- For assortment 519 M 236K



LxPxH mm	code	
415x188x45	U05190236Q	1



1/2

### 519 M 236K2



Bi-colour foam module with assortment (20 pcs.)

pcs	description	item/size
16	Hexagonal sockets /10-11-12-13-14-15-16-17-18-19-21-22-24-27-30-32	235 1/2 EN
1	Extensions	236 1/2
1	Chain extension in Aluminium for sockets	236 K 1/2
1	Reversible ratchet with sealed mechanism (certified IP51)	237 A 1/2
1	Universal joint	241 1/2
1	Bi-colour foam module (empty)	519 M 236K2V

LxPxH mm	kg	code	
415x188x45	3,5	U05190239	1

### 519 M 236K2V

Bi-colour foam module (empty)

- For assortment 519 M 236K2



LxPxH mm	code	
415x188x45	U05190239Q	1



1/2

### 519 M 236KE



Bi-colour foam module with assortment (18 pcs.)

pcs	description	item/size
1	Bit-holder chain extension in Aluminium	236 KE 1/2
8	Impact bits for hexagonal screws - 1/2" connection /5-6-8-10-12-14-17-19	687 E
9	Impact bits for TORX® screws - 1/2" connection /T25-T27-T30-T40-T45- T50-T55-T60-T70	687 TX
1	Bi-colour foam module (empty)	519 M 236KEV

LxPxH mm	kg	code	
415x188x45	2	U05190240	1

### 519 M 236KEV

Bi-colour foam module (empty)

- For assortment 519 M 236KE



LxPxH mm	code	
415x188x45	U05191036Q	1



### 519 M 273



Bi-colour foam module with assortment (50 pcs.)

pcs	description	item/size
13	Hexagonal sockets /4-4,5-5-5,5-6-7-8-9-10-11-12-13-14	235 1/4 EN
1	Reversible ratchet with revolving handle	237 1/4 AK
1	Spinner with handle	243 1/4
1	Flexible spinner with handle	243 1/4 SN
1	Adapter	247 1/4
1	T-handle key with jointed square drive	273 1/4 Q
31	Assortment with bits and reversible ratchet (31 pcs.)	606 1/4 SK
1	Bit-holder sockets	684/1
1	Bi-colour foam module (empty)	519 M 273V

LxPxH mm	kg	code	
415x188x45	1,4	U05191020	1

### 519 M 273V

Bi-colour foam module (empty)

- For assortment 519 M 273



LxPxH mm	code	
415x188x45	U05191020Q	1



1/2 3/8

### 519 M 278



Bi-colour foam module with assortment (9 pcs.)

pcs	description	item/size
1	Adapter	246 1/2
3	Glowplug wrenches with jointed socket /8L-9L-10L	278 D
2	Spark plug sockets/14-14L	279 3/8
3	Spark plug sockets/16-18-20,8	279 N 1/2
1	Bi-colour foam module (empty)	519 M 278V

LxPxH mm	kg	code	
415x188x45	1,4	U05191022	1

### 519 M 278V

Bi-colour foam module (empty)

- For assortment 519 M 278



LxPxH mm	code	
415x188x45	U05191022Q	1



### 519 M 280HATX



Bi-colour foam module with assortment (7 pcs.)

pcs	description	item/size
7	Angled keys with handgrip for TORX® screws /T10-T15-T20-T25-T27-T30-T40	280 HATX
1	Bi-colour foam module (empty)	519 M 280HATXV

LxPxH mm	gr	code	
415x188x45	500	U05190947	1

### 519 M 280HATXV

Bi-colour foam module (empty)

- For assortment 519 M 280HATX



LxPxH mm	code	
415x188x45	U05190181Q	1



### 519 M 280HG



Bi-colour foam module with assortment (7 pcs.)

pcs	description	item/size
7	Angled hexagon keys with bimaterial handgrip /3-4-5-6-7-8-10	280 HG
1	Bi-colour foam module (empty)	519 M 280HGV

LxPxH mm	kg	code	
415x565x45	1,1	U05191945	1



### 519 M 280HGTS



Bi-colour foam module with assortment (7 pcs.)

pcs	description	item/size
7	Angled hexagon keys with spherical head and bimaterial handgrip / 3-4-5-6-7-8-10	280 HGTS
1	Bi-colour foam module (empty)	519 M 280HGV

LxPxH mm	kg	code	
415x188x45	1,1	U05191946	1

### 519 M 280HGV

Bi-colour foam module (empty)

- For assortment 519 M 280HG, 519 M 280HGTS



LxPxH mm	code	
415x188x45	U05190180Q	1



### 519 M 280N1



Bi-colour foam module with assortment (117 pcs.)

pcs	description	item/size
9	Set of 9 angled hexagon keys / 1,5-2-2,5-3-4-5-6-8-10	280 S9
8	Set of 8 angled keys for TORX® screws / T10-T15-T20-T25-T27-T30-T40-T45	280 TX/S8C
100	Assortment of bits with special shapes - 1/4" (100 pcs.)	692 J100
1	Bi-colour foam module (empty)	519 M 280N1V

LxPxH mm	kg	code	
415x188x45	1,5	U05191013	1

### 519 M 280N1V

Bi-colour foam module (empty)

- For assortment 519 M 280N1



LxPxH mm	code	
415x188x45	U05191013Q	1

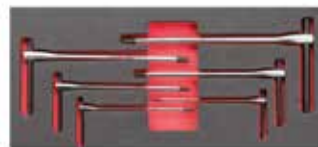

### 519 M 280TK



Bi-colour foam module with assortment (6 pcs.)

pcs	description	item/size
6	T-handle hexagon keys with sliding bar / 2,5-3-4-5-6-8	280 TK
1	Bi-colour foam module (empty)	519 M 280TKAV

LxPxH mm	gr	code	
415x188x45	600	U05190935	1

### 519 M 280TKAV

Bi-colour foam module (empty)

- For assortment 519 M 280TKA



LxPxH mm	code	
415x188x45	U05191040Q	1



### 519 M 285A1



Bi-colour foam module with assortment (17 pcs.)

pcs	description	item/size
17	Combination wrenches /6-7-8-9-10-11-12- 285 13-14-15-16-17-18-19-21-22-24	285
1	Bi-colour foam module (empty)	519 M 285A1AV

LxPxH mm	kg	code	
415x188x45	1,9	U05190921	1

### 519 M 285A1AV

Bi-colour foam module (empty)

- For assortment 519 M 285A1



LxPxH mm	code	
415x188x45	U05191041Q	1



### 519 M 285A2



Bi-colour foam module with assortment (5 pcs.)

pcs	description	item/size
5	Combination wrenches/27-29-30-32-34	285
1	Bi-colour foam module (empty)	519 M 285A2AV

LxPxH mm	kg	code	
415x188x45	3	U05190943	1

### 519 M 285A2AV

Bi-colour foam module (empty)

- For assortment 519 M 285A2A



LxPxH mm	code	
415x188x45	U05191042Q	1





NEW



### 519 M 285J16

Bi-colour foam module with assortment (16 pcs.)

pcs	description	item/size
16	Combination wrench /6-7-8-9-10-11-12-13-14-15-16-17-18-19-22-24	285 J
1	Bi-colour foam module (empty)	519 M 285J16V

LxPxH mm	kg	code	
415x188x45	2,1	U05191014	1

### 519 M 285J16V

Bi-colour foam module (empty)

- For assortment 519 M 285J16



LxPxH mm	code	
415x188x45	U05191014Q	1



### 519 M 285KA

Bi-colour foam module with assortment (12 pcs.)

pcs	description	item/size
12	Reversible ratchet combination wrenches with locking ring /8-9-10-11-12-13-14-15-16-17-18-19	285 KA
1	Bi-colour foam module (empty)	519 M 285KAV

LxPxH mm	kg	code	
415x188x45	1,3	U05190944	1

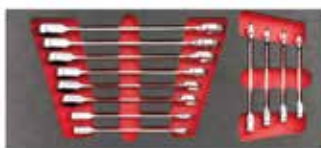

NEW



### 519 M 285KB

Bi-colour foam module with assortment (12 pcs.)

pcs	description	item/size
12	Flat ratchet combination wrenches/ 8-9-10-11-12-13-14-15-16-17-18-19	285 KB
1	Bi-colour foam module (empty)	519 M 285KBV

LxPxH mm	kg	code	
415x188x45	1,3	U05191060	1

### 519 M 285KAV

Bi-colour foam module (empty)

- For assortments 519 M 285KA and 519 M 285KB



LxPxH mm	code	
415x188x45	U05190944Q	1



### 519 M 285KF

Bi-colour foam module with assortment (15 pcs.)

pcs	description	item/size
12	Hinged jointed reversible ratchet combination wrenches/ 8-9-10-11-12-13-14-15-16-17-18-19	285 KF
1	Adapter for 1/4 sockets for ratchet wrench 10 mm	
1	Adapter for 1/4 bits for ratchet wrench 10 mm	
1	Adapter for 1/2 sockets for ratchet wrench 19 mm	
1	Bi-colour foam module (empty)	519 M 285KFV

LxPxH mm	kg	code	
415x188x45	1,5	U05190964	1

### 519 M 285KFV

Bi-colour foam module (empty)

- For assortment 519 M 285KF



LxPxH mm	code	
415x188x45	U05190964Q	1



### 519 M 285P1

Bi-colour foam module with assortment (13 pcs.)

pcs	description	item/size
13	Combination wrenches, inch sizes / 1/4-5/16-3/8-7/16-1/2-9/16-5/8-11/16-3/4-13/16-7/8-15/16-1	285 P
1	Bi-colour foam module (empty)	519 M 285P1V

LxPxH mm	kg	code	
415x188x45	1,8	U05190974	1

### 519 M 285P1V

Bi-colour foam module (empty)

- For assortment 519 M 285P1



LxPxH mm	code	
415x188x45	U05190974Q	1



### 519 M 291N13

Bi-colour foam module with assortment (13 pcs.)

pcs	description	item/size
13	Double ended hollow offset socket wrenches /7-8-9-10-11-12-13-14-15-16-17-18-19	291 N
1	Bi-colour foam module (empty)	519 M 291N13V

LxPxH mm	kg	code	
415x188x45	2,5	U05191001	1

### 519 M 291N13V

Bi-colour foam module (empty)

- For assortment 519 M 291N13



LxPxH mm	code	
415x188x45	U05191001Q	1



### 519 M 294B

Bi-colour foam module with assortment (4 pcs.)

pcs	description	item/size
1	Lock-grip rack-type pliers with short jaws	135 A/250
1	Professional scissors for electricians	207 E
1	Short adjustable wrench	294 AC
1	Adjustable wrenches with quick adjustment	294 AD/250
1	Empty bi-colour foam module	519 M 294BV

LxPxH mm	kg	code	
415x188x45	1,9	U05191015	1

### 519 M 294BV

Empty bi-colour foam module

- For assortment 519 M 294B



LxPxH mm	code	
415x188x45	U05191015Q	1



### 519 M 299

Bi-colour foam module with assortment (5 pcs.)

pcs	description	item/size
5	Hexagonal socket spinners with grip / 6-7-8-10-13	299
1	Bi-colour foam module (empty)	519 M 299V

LxPxH mm	gr	code	
415x188x45	957	U05190299	1

## 519 M 299V

### Bi-colour foam module (empty)

- For assortment 519 M 299



LxPxH mm	code	
415x188x45	U05190299Q	1

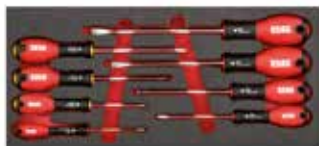

## 519 M 322H

### Bi-colour foam module with assortment (8 pcs.)

pcs	description	item/size
5	Screwdrivers for slot-head screws / 0,5x3x75-0,8x4x100-1x5,5x125-1,2x6,5x150-1,6x8x175	322
3	Screwdrivers for PHILLIPS® screws / 0x75-1x100-2x125	322 PH
1	Bi-colour foam module (empty)	519 M 322HAV

LxPxH mm	kg	code	
415x188x45	600	U05190927	1

## 519 M 322HAV

### Bi-colour foam module (empty)

- For assortment 519 M 322H



LxPxH mm	code	
415x188x45	U05191043Q	1



## 519 M 322STX

### Bi-colour foam module with assortment (6 pcs.)

pcs	description	item/size
6	Screwdrivers for TORX® Tamper Resistant screws / T10x75-T15x75-T20x100-T25x100-T30x125-T40x125	322 STX
1	Bi-colour foam module (empty)	519 M 322STXV

LxPxH mm	kg	code	
415x188x45	600	U05190929	1

## 519 M 322STXV

### Bi-colour foam module (empty)

- For assortment 519 M 322STX



LxPxH mm	code	
415x188x45	U05190929Q	1



## 519 M 324H

### Bi-colour foam module with assortment (8 pcs.)

pcs	description	item/size
4	Screwdrivers for slot-head screws / 0,5x3x75-0,8x4x100-1x5,5x125-1,2x6,5x150	324
1	Screwdrivers for slot-head screws/0,6x3,5x100	324 D
1	Screwdrivers for slot-head screws/1,6x8x175	324 E
2	Screwdrivers for PHILLIPS® screws / 1x100-2x125	324 PH
1	Bi-colour foam module (empty)	519 M 324HAV

LxPxH mm	kg	code	
415x188x45	800	U05190910	1

## 519 M 324HAV

### Bi-colour foam module (empty)

- For assortment 519 M 324H



LxPxH mm	code	
415x188x45	U05191044Q	1



## 519 M 324STX

### Bi-colour foam module with assortment (7 pcs.)

pcs	description	item/size
7	Screwdrivers for TORX® Tamper Resistant screws / T10x75-T15x75-T20x100-T25x100-T27x100-T30x125-T40x150	324 STX
1	Bi-colour foam module (empty)	519 M 324STXAV

LxPxH mm	kg	code	
415x188x45	800	U05190911	1

## 519 M 324STXAV

### Bi-colour foam module (empty)

- For assortment 519 M 324STX



LxPxH mm	code	
415x188x45	U05191045Q	1



## 519 M 333K

### Bi-colour foam module with assortment (23 pcs.)

pcs	description	item/size
1	COMBIDRIVE magnetic bit-holder	333 1/4 MG
1	COMBIDRIVE sockets holder	333 1/4 Q
5	Reversible COMBIDRIVE blades for hex socket screws/2,5-3-4-5-6	333 E
1	COMBIDRIVE handgrip with 3 functions	333 K
2	Reversible COMBIDRIVE blades for PHILLIPS® screws/(0-1)-(2-3)	333 PH
4	Reversible COMBIDRIVE blades for TORX® screws / (T8-T9)-(T10-T15)-(T20-T25)-(T30-T40)	333 TX
4	Bits for slot-head screws -1/4" / 0,6x4,5-1x5,5-1,2x6,5-1,6x8	660
4	Bits for POZIDRIV® - SUPADRIV® screws -1/4"/0-1-2-3	660 PZ
1	Bi-colour foam module (empty)	519 M 333KV

LxPxH mm	kg	code	
415x188x45	1	U05190978	1

## 519 M 333KV

### Bi-colour foam module (empty)

- For assortment 519 M 333K



LxPxH mm	code	
415x188x45	U05190978Q	1



## 519 M 382F

### Bi-colour foam module with assortment (7 pcs.)

pcs	description	item/size
1	Chisels	362/175
3	Pin punches/2x115-3x125-4x145	367
1	Centre punches	368/3x100
1	Mallets	376/28
1	Hammers for mechanics with graphite handle	382 F/500
1	Bi-colour foam module (empty)	519 M 382FAV

LxPxH mm	kg	code	
415x188x45	1,5	U05190926	1

## 519 M 382FAV

### Bi-colour foam module (empty)

- For assortment 519 M 382FA



LxPxH mm	code	
415x188x45	U05191046Q	1



1/4

### 519 M 613AEA



Bi-colour foam module with assortment (46 pcs.)

pcs	description	item/size
10	Hexagonal sockets / 5,5-6-7-8-9-10-11-12-13-14	235 1/4 EN
2	Extensions/50-100	236 1/4
1	Reversible ratchet with sealed mechanism (certified IP51)	237 A 1/4
1	T-handle with sliding square drive	240 1/4
1	Universal joint	241 1/4
1	Spinner with handle	243 1/4
9	Set of 9 long angled hexagon keys with spherical head/1,5-2-2,5-3-4-5-6-8-10	280 LTS/S9
3	Bits for slot-head screws -1/4"/ 0,6x4,5-1x5,5-1,6x8	660
5	Bits for hex socket screws -1/4"/ 3-4-5-6-8	660 E
3	Bits for PHILLIPS® screws -1/4"/ 1-2-3	660 PH
3	Bits for POZIDRIV® - SUPADRIV® screws -1/4"/1-2-3	660 PZ
6	Bits for TORX® Tamper Resistant screws -1/4"/ T15-T20-T25-T27-T30-T40	660 STX
1	Bit-holder sockets	684/1/4
1	Bi-colour foam module (empty)	519 M 613AEAAV

LxPxH mm	kg	code	
415x188x45	1	U05190940	1



1/4

### 519 M 613AEB



Bi-colour foam module with assortment (46 pcs.)

pcs	description	item/size
10	Hexagonal sockets / 5,5-6-7-8-9-10-11-12-13-14	235 1/4 EN
2	Extensions/50-100	236 1/4
1	Reversible ratchet with sealed mechanism	237 B 1/4
1	T-handle with sliding square drive	240 1/4
1	Universal joint	241 1/4
1	Spinner with handle	243 1/4
9	Set of 9 long angled hexagon keys with spherical head/1,5-2-2,5-3-4-5-6-8-10	280 LTS/S9
3	Bits for slot-head screws -1/4"/ 0,6x4,5-1x5,5-1,6x8	660
5	Bits for hex socket screws -1/4"/ 3-4-5-6-8	660 E
3	Bits for PHILLIPS® screws -1/4"/ 1-2-3	660 PH
3	Bits for POZIDRIV® - SUPADRIV® screws -1/4"/1-2-3	660 PZ
6	Bits for TORX® Tamper Resistant screws -1/4"/ T15-T20-T25-T27-T30-T40	660 STX
1	Bit-holder sockets	684/1/4
1	Bi-colour foam module (empty)	519 M 613AEAAV

LxPxH mm	kg	code	
415x188x45	1	U05190924	1

### 519 M 613AEAAV

Bi-colour foam module (empty)

- For assortment 519 M 613AEA, 519 M 613AEB

LxPxH mm	code	
415x188x45	U05191047Q	1



3/8

### 519 M 613BEA



Bi-colour foam module with assortment (20 pcs.)

pcs	description	item/size
15	Hexagonal sockets / 7-8-9-10-11-12-13-14-15-16-17-18-19-21-22	235 3/8 E
2	Extensions/125-250	236 3/8
1	Reversible ratchet with sealed mechanism (certified IP51)	237 A 3/8
1	T-handle with sliding square drive	240 3/8 N
1	Universal joint	241 3/8
1	Bi-colour foam module (empty)	519 M 613BEV

LxPxH mm	kg	code	
415x188x45	1,5	U05190928	1



3/8

### 519 M 613BEB



Bi-colour foam module with assortment (20 pcs.)

pcs	description	item/size
15	Hexagonal sockets / 7-8-9-10-11-12-13-14-15-16-17-18-19-21-22	235 3/8 E
2	Extensions/125-250	236 3/8
1	Reversible ratchet with sealed mechanism	237 B 3/8
1	T-handle with sliding square drive	240 3/8 N
1	Universal joint	241 3/8
1	Bi-colour foam module (empty)	519 M 613BEV

LxPxH mm	kg	code	
415x188x45	1,6	U05190941	1

### 519 M 613BEV

Bi-colour foam module (empty)

- For assortment 519 M 613BEA, 519 M 613BEB

LxPxH mm	code	
415x188x45	U05190928Q	1



1/2

### 519 M 613CEA



Bi-colour foam module with assortment (23 pcs.)

pcs	description	item/size
18	Hexagonal sockets / 8-10-11-12-13-14-15-16-17-18-19-21-22-23-24-27-30-32	235 1/2 EN
2	Extensions/125-250	236 1/2
1	Reversible ratchet with sealed mechanism (certified IP51)	237 A 1/2
1	T-handle with sliding square drive	240 1/2 N
1	Universal joint	241 1/2
1	Bi-colour foam module (empty)	519 M 613CEAAV

LxPxH mm	kg	code	
415x188x45	3,2	U05190942	1



1/2

### 519 M 613CEB



Bi-colour foam module with assortment (23 pcs.)

pcs	description	item/size
18	Hexagonal sockets / 8-10-11-12-13-14-15-16-17-18-19-21-22-23-24-27-30-32	235 1/2 EN
2	Extensions/125-250	236 1/2
1	Reversible ratchet with sealed mechanism	237 B 1/2
1	T-handle with sliding square drive	240 1/2 N
1	Universal joint	241 1/2
1	Bi-colour foam module (empty)	519 M 613CEAAV

LxPxH mm	kg	code	
415x188x45	3,3	U05190925	1

### 519 M 613CEAAV

Bi-colour foam module (empty)

- For assortment 519 M 613CEA, 519 M 613CEB

LxPxH mm	code	
415x188x45	U05191048Q	1

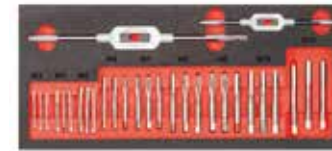

### 519 M 618MF2

Bi-colour foam module with assortment (29 pcs.)

pcs	description	item/size
27	Hand taps/M3-M4-M5-M6-M7-M8-M9-M10-M12 (3 pz cad)	988 T
2	Manual tap wrenches	618 M/1-2
1	Bi-colour foam module (empty)	519 M 618MF2V

LxPxH mm	gr	code	
415x188x45	550	U05191056	1

### 519 M 618MF2V

Bi-colour foam module (empty)

- For assortment 519 M 618MF2

LxPxH mm	code	
415x188x45	U05191056Q	1



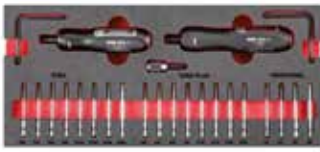

## 519 M 824SK23

Bi-colour foam module with assortment (23 pcs.)

pcs	description	item/size
4	Bits for hex socket screws - 1/4" / 2-3-4-5	664 EL
8	Bits for TORX PLUS® screws - 1/4" / IP6-IP7-IP8-IP9-IP10-IP15-IP20-IP25	664 IP
8	Bits for TORX® screws - 1/4" / T6-T7-T8-T9-T10-T15-T20-T25	664 TX
1	Magnetic bit-holder adapter - 1/4"	672 AMG
1	Torque screwdrivers	824 A/0,5÷2,5
1	Torque screwdrivers	824 A/1,4÷10
1	Bi-colour foam module (empty)	519 M 824SK23V

LxPxH mm	kg	code	
415x188x45	1,1	U05190977	1

## 519 M 824SK23V

Bi-colour foam module (empty)

- For assortment 519 M 824SK23



LxPxH mm	code	
415x188x45	U05190977Q	1



## 519 M 929PC1

Bi-colour foam module with assortment (1 pc.)

- Suitable only for drawers with height 130-200-270 mm

pcs	description	item/size
1	Magnesium impact wrench	929 PC1 1/2
1	Bi-colour foam module (empty)	519 M 943PC1V

LxPxH mm	kg	code	
415x188x45	2,2	U05191038	1



## 519 M 942PC3

Bi-colour foam module with assortment (1 pc.)

- Suitable only for drawers with height 130-200-270 mm

pcs	description	item/size
1	Extra-compact impact wrench	942 PC3 1/2
1	Bi-colour foam module (empty)	519 M 942PC3V

LxPxH mm	kg	code	
415x188x45	1,4	U05191039	1

## 519 M 942PC3V

Bi-colour foam module (empty)

- For assortment 519 M 943PC3  
- Suitable only for drawers with height 130-200-270 mm



LxPxH mm	code	
415x188x45	U05191008Q	1



## 519 M 943PC1

Bi-colour foam module with assortment (1 pc.)

- Suitable only for drawers with height 130-200-270 mm

pcs	description	item/size
1	Magnesium impact wrench with LED - the top	943 PC1 1/2
1	Bi-colour foam module (empty)	519 M 943PC1V

LxPxH mm	kg	code	
415x188x45	2,4	U05191037	1

## 519 M 943PC1V

Bi-colour foam module (empty)

- For assortment 519 M 943PC1 and 519 M 929PC1  
- Suitable only for drawers with height 130-200-270 mm



LxPxH mm	code	
415x188x45	U05191006Q	1



## 519 M 990A5B

Bi-colour foam module with assortment (5 pcs.)

- Bastard cut

pcs	description	item/size
1	Flat square file	990 B PA/200
1	Half-round file	990 B PB/200
1	Round file	990 B PC/200
1	Square file	990 B PD/200
1	Triangular file	990 B PE/200
1	Bi-colour foam module (empty)	519 M 990A5BV

LxPxH mm	gr	code	
415x188x45	900	U05191012	1



## 519 M 990A5MD

Bi-colour foam module with assortment (5 pcs.)

- Second cut

pcs	description	item/size
1	Flat square file	990 M PA/200
1	Half-round file	990 M PB/200
1	Round file	990 M PC/200
1	Square file	990 M PD/200
1	Triangular file	990 M PE/200
1	Bi-colour foam module (empty)	519 M 990A5BV

LxPxH mm	gr	code	
415x188x45	800	U05191011	1

## 519 M 990A5BV

Bi-colour foam module (empty)

- For assortment 519 M 990A5B and 519 M 990A5MD



LxPxH mm	code	
415x188x45	U05191011Q	1



## 519 M 995K

Bi-colour foam module with assortment (501 pcs.)

pcs	description	item/size
1	Hand riveter	995 A
500	Aluminium rivets / 3x8-3x10-4x10-4x12-4,8x12	995 AL
1	Bi-colour foam module (empty)	519 M 995KV

LxPxH mm	kg	code	
415x188x45	1,5	U05190139	1

## 519 M 995KV

Bi-colour foam module (empty)

- For assortment 519 M 995K



LxPxH mm	code	
415x188x45	U05190139Q	1



## 519 M SK6V

Foam module for small parts (empty)

LxPxH mm	code	
415x188x45	U05191049Q	1

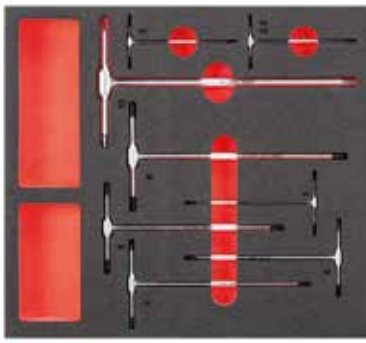

NEW

## 519 M 280T

Bi-colour foam module with assortment (8 pcs.)

pcs	description	item/size
8	T-handle hexagon keys/ 2-2,5-3-4-5-6-8-10	280 T
1	Bi-colour foam module (empty)	519 M 280TV

LxPxH mm	kg	code	
415x376x45	1,4	U05191059	1

## 519 M 280TV

Bi-colour foam module (empty)

- For assortment 519 M 280T



LxPxH mm	code	
415x376x45	U05191059Q	1

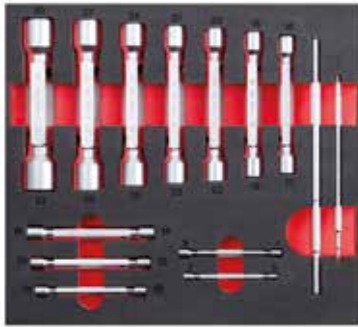

NEW

## 519 M 290E14

Bi-colour foam module with assortment (14 pcs.)

pcs	description	item/size
12	Double ended tubular socket wrenches /6x7-8x9-10x11-12x13-14x15-16x17-18x19- 20x22-21x23-24x26-27x29-30x32-36x41	290 E
2	Drive bars	292/1-2
1	Bi-colour foam module (empty)	519 M 290E14V

LxPxH mm	kg	code	
415x376x45	4,6	U05191057	1

## 519 M 290E14V

Bi-colour foam module (empty)

- For assortment 519 M 290E14



LxPxH mm	code	
415x376x45	U05191057Q	1

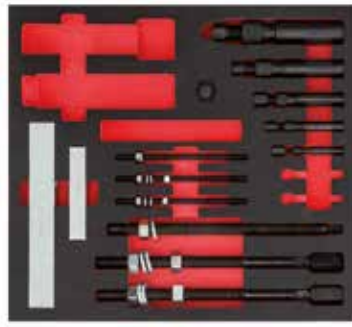

XL

## 519 M 468NKS7

Bi-colour foam module with assortment (7 pcs.)

pcs	description	item/size
5	Inside expansion pullers/ 3-4-5-6-7	468 C
1	Supports for expansion pullers	468 D/1
1	Adapter for slide hammers 468 D2 - 468 D3 - 468 E2	468 F1
1	Bi-colour foam module (empty)	519 M 468NKS11V

LxPxH mm	kg	code	
415x376x45	4,1	U05190983	1



XL

## 519 M 468NKS11

Bi-colour foam module with assortment (11 pcs.)

pcs	description	item/size
9	Inside expansion pullers/ 1-2-3-4-5-6-7-8-9	468 C
1	Supports for expansion pullers	468 D/1
1	Adapter for slide hammers 468 D2 - 468 D3 - 468 E2	468 F1
1	Bi-colour foam module (empty)	519 M 468NKS11V

LxPxH mm	kg	code	
415x376x45	6,8	U05190984	1

## 519 M 468NKS11V

Bi-colour foam module (empty)

- For assortment 519 M 468NKS11 - 519 M 468NKS7



LxPxH mm	code	
415x376x45	U05190984Q	1



3/4

## 519 M 612B

Bi-colour foam module with assortment (17 pcs.)

pcs	description	item/size
13	Bihexagonal sockets / 22-23-24-26-27-28-30-32-36-38-41- 46-50	235 3/4 N
2	Extensions/200-400	236 3/4
1	Reversible ratchet with sealed mechanism	237 B 3/4
1	T-handle with sliding square drive	240 3/4 N
1	Bi-colour foam module (empty)	519 M 612EBV

LxPxH mm	kg	code	
415x376x45	10,8	U05190991	1



3/4

## 519 M 612EB

Bi-colour foam module with assortment (17 pcs.)

- Suitable only for drawers with height 130-200-270 mm

pcs	description	item/size
13	Hexagonal sockets / 22-23-24-26-27-28- 30-32-36-38-41-46-50	235 3/4 EN
2	Extensions/200-400	236 3/4
1	Reversible ratchet with sealed mechanism	237 B 3/4
1	T-handle with sliding square drive	240 3/4 N
1	Bi-colour foam module (empty)	519 M 612EBV

LxPxH mm	kg	code	
415x376x45	10,6	U05190990	1



3/4

**519 M 612PB**

**XL**

**Bi-colour foam module with assortment (17 pcs.)**

- Suitable only for drawers with height 130-200-270 mm

pcs	description	item/size
13	Bihexagonal sockets, inch sizes / 7/8-15/16-1-1 1/16-1 1/8-1 1/4-1 5/16-1 7/16-1 1/2-1 5/8-1 13/16-1 7/8-2	235 3/4 PN
2	Extensions/200-400	236 3/4
1	Reversible ratchet with sealed mechanism	237 B 3/4
1	T-handle with sliding square drive	240 3/4 N
1	Bi-colour foam module (empty)	519 M 612EBV

LxPxH mm	kg	code	
415x376x45	11	U05190992	1

**519 M 612EBV**

**Bi-colour foam module (empty)**

- For assortment 519 M 612EB, 519 M 612B, 519 M 612PB  
- Suitable only for drawers with height 130-200-270 mm



LxPxH mm	code	
415x376x45	U05190990Q	1



1/2

**519 M 612CLB**

**XL**

**Bi-colour foam module with assortment (35 pcs.)**

pcs	description	item/size
20	Hexagonal sockets /8-9-10-11-12-13-14-15-16-17-18-19-20-21-22-23-24-27-30-32	235 1/2 EN
10	Long bihexagonal sockets / 10-12-13-14-17-19-22-24-27-30	235 1/2 LN
2	Extensions/125-250	236 1/2
1	Reversible ratchet with sealed mechanism	237 B 1/2
1	T-handle with sliding square drive	240 1/2 N
1	Universal joint	241 1/2
1	Bi-colour foam module (empty)	519 M 612CLAV

LxPxH mm	kg	code	
415x376x45	5,2	U05190989	1

**519 M 612CLAV**

**Bi-colour foam module (empty)**

- For assortment 519 M 612CLA e 519 M 612CLB



LxPxH mm	code	
415x376x45	U05190988Q	1



1/2

**519 M 612MPB**

**XL**

**Bi-colour foam module with assortment (35 pcs.)**

pcs	description	item/size
15	Bihexagonal sockets / 10-11-12-13-14-15-16-17-18-19-22-24-27-30-32	235 1/2 N
15	Bihexagonal sockets, inch sizes / 3/8-7/16-1/2-9/16-5/8-11/16-3/4-13/16-7/8-15/16-1-1 1/16-1 1/8-1 3/16-1 1/4	235 1/2 PN
2	Extensions/125-250	236 1/2
1	Reversible ratchet with sealed mechanism	237 B 1/2
1	T-handle with sliding square drive	240 1/2 N
1	Universal joint	241 1/2
1	Bi-colour foam module (empty)	519 M 612CMPAV

LxPxH mm	kg	code	
415x376x45	4,7	U05190987	1

**519 M 612CMPAV**

**Bi-colour foam module (empty)**

- For assortment 519 M 612MPA - 519 M 612MPB



LxPxH mm	code	
415x376x45	U05190986Q	1



1/2

**519 M 612CLA**

**XL**

**Bi-colour foam module with assortment (35 pcs.)**

pcs	description	item/size
20	Hexagonal sockets /8-9-10-11-12-13-14-15-16-17-18-19-20-21-22-23-24-27-30-32	235 1/2 EN
10	Long bihexagonal sockets / 10-12-13-14-17-19-22-24-27-30	235 1/2 LN
2	Extensions/125-250	236 1/2
1	Reversible ratchet with sealed mechanism (certified IP51)	237 A 1/2
1	T-handle with sliding square drive	240 1/2 N
1	Universal joint	241 1/2
1	Bi-colour foam module (empty)	519 M 612CLAV

LxPxH mm	kg	code	
415x376x45	5,1	U05190988	1



1/2

**519 M 612MPA**

**XL**

**Bi-colour foam module with assortment (35 pcs.)**

pcs	description	item/size
15	Bihexagonal sockets /10-11-12-13-14-15-16-17-18-19-22-24-27-30-32	235 1/2 N
15	Bihexagonal sockets, inch sizes /3/8-7/16-1/2-9/16-5/8-11/16-3/4-13/16-7/8-15/16-1-1 1/16-1 1/8-1 3/16-1 1/4	235 1/2 PN
2	Extensions/125-250	236 1/2
1	Reversible ratchet with sealed mechanism (certified IP51)	237 A 1/2
1	T-handle with sliding square drive	240 1/2 N
1	Universal joint	241 1/2
1	Bi-colour foam module (empty)	519 M 612CMPAV

LxPxH mm	kg	code	
415x376x45	4,6	U05190986	1



**519 M 618MF1**

**XL**

**Bi-colour foam module with assortment (40 pcs.)**

pcs	description	item/size
9	Round dies/M3-M4-M5-M6-M7-M8-M9-M10-M12	988 S
27	Hand taps/M3-M4-M5-M6-M7-M8-M9-M10-M12 (3 pcs each)	988 T
2	Die stocks	618 P/1-2
2	Manual tap wrenches	618 M/1-2
1	Bi-colour foam module (empty)	519 M 618MF1V

LxPxH mm	kg	code	
415x376x45	1,5	U05191055	1

**519 M 618MF1V**

**Bi-colour foam module (empty)**

- For assortment 519 M 618MF1



LxPxH mm	code	
415x376x45	U05191055Q	1



1/2

### 519 M 811ND



XL

Bi-colour foam module with assortment (2 pcs.)

pcs	description	item/size
1	Reversible ratchet with 72 teeth	811 E/1/2
1	Torque rod	811 SA/40÷200
1	Bi-colour foam module (empty)	519 M 811NDV

LxPxH mm	kg	code	
415x376x45	1,6	U05190995	1

### 519 M 811NDV

Bi-colour foam module (empty)

- For assortment 519 M 811 ND



LxPxH mm	code	
415x376x45	U05190995Q	1



NEW

### 519 M 150



XXL

Bi-colour foam module with assortment (49 pcs.)

pcs	description	item/size
1	Pliers with straight nose for internal circlips	127 C/19÷60
1	Pliers with nose bent at 90° for internal circlips	127 CP/19÷60
1	Pliers with straight nose for external circlips	128 C/19÷60
1	Pliers with nose bent at 90° for external circlips	128 CP/19÷60
1	Half-round extra-long nose pliers with straight jaws	133 DX/160
1	Combination pliers	150 DX/180
1	Box-joint adjustable pliers	180 C/250
1	Heavy-duty diagonal cutting nippers	188 DX/160
1	Scissors for electricians, stainless steel blades	207 D
1	Chisels	362/175
5	Pin punches /2x115-3x125-4x145-5x165-6x180	367
1	Mallets	376/35
1	Hammers for mechanics	382/500
32	Assortment with bits and reversible ratchet - 1/4" (32 pcs.)	692 J32
1	Bi-colour foam module (empty)	519 M 150V

LxPxH mm	kg	code	
565x415x45	4,6	U05191061	1

### 519 M 150V

Bi-colour foam module (empty)

- For assortment 519 M 150



LxPxH mm	code	
565x415x45	U05191061Q	1

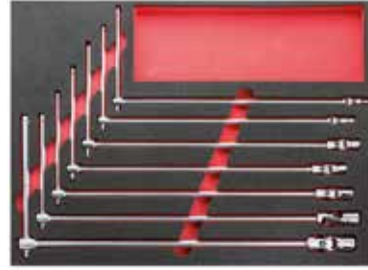

### 519 M 276

Bi-colour foam module with assortment (7 pcs.)

pcs	description	item/size
7	T-handle wrenches with jointed hexagonal socket/7-8-10-11-13-17-19	276 CE
1	Bi-colour foam module (empty)	519 M 276AV

LxPxH mm	kg	code	
565x415x45	3,1	U05190936	1

### 519 M 276AV

Plastic tray (empty)

- For assortment 519 M 276



LxPxH mm	code	
565x415x45	U05191051Q	1

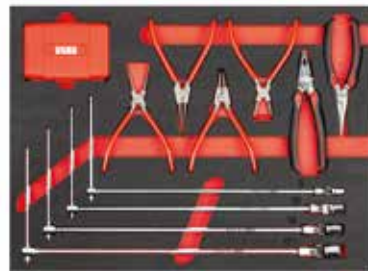

### 519 M 276C

Bi-colour foam module with assortment (42 pcs.)

pcs	description	item/size
1	Pliers with straight nose for internal circlips	127 C/19÷60
1	Pliers with nose bent at 90° for internal circlips	127 CP/19÷60
1	Pliers with straight nose for external circlips	128 C/19÷60
1	Pliers with nose bent at 90° for external circlips	128 CP/19÷60
1	Half-round extra-long nose pliers with straight jaws	133 AX/160
1	Combination pliers	150 AX/180
4	T-handle wrenches with jointed hexagonal socket/8-10-13-17	276 CE
32	Assortment with bits and reversible ratchet - 1/4" (32 pcs.)	692 J32
1	Bi-colour foam module (empty)	519 M 276CV

LxPxH mm	kg	code	
565x415x45	3	U05191052	1

### 519 M 276CV

Plastic tray (empty)

- For assortment 519 M 276C



LxPxH mm	code	
565x415x45	U05191052Q	1



NEW

### 519 M 423N16

Bi-colour foam module with assortment (16 pcs.)

- Suitable only for drawers with height 130-200-270 mm

pcs	description	item/size
1	Hammer with flat round and curved chisel heads	392/40
1	Hammer with flat round and flat square heads	393/40
1	Comma shaped wedged dolly	401
1	Large grooved dolly	401 A
1	Dolly for body repair	402 A
1	Dolly for body repair	402 B
1	Dolly for body repair	402 C
1	Dolly for body repair	404
1	Double spoon with one curved blade and a flat one	410 C
1	Facing narrow body spoon, long model	411
1	Light curved spoon, short model	412
1	Flat serrated spoon for thinning out operations	412 B
1	Hammer with flat round head and straight pointed peen	415 A
1	Adjustable file holder	416 N
2	Flat flexible files/3,5-4,5	416 NA
1	Bi-colour foam module (empty)	519 M 423N16V

LxPxH mm	kg	code	
565x415x45	20,5	U05191058	1

### 519 M 423N16V

Bi-colour foam module (empty)

- For assortment 519 M 423N16

- Suitable only for drawers with height 130-200-270 mm



LxPxH mm	code	
565x415x45	U05191058Q	1



NEW

1/4 1/2



XXL

**519 M 601**  
Bi-colour foam module with assortment (116 pcs.)

pcs	description	item/size
16	Combination wrenches 6-7-8-9-10-11-12-13-14-15-16-17-18-19-22-24	285 J
1	Reversible ratchet	237 C 1/4
1	Reversible ratchet	237 C 1/2
1	Socket-holder	243 1/4
12	Hexagonal sockets 1/4" 4-4,5-5,5-6-7-8-9-10-11-12-13-14	
7	Long hexagonal sockets 6-8-10-11-12-13-14 mm	
3	Sockets 1/2" TORX®	E6-E8-E10
2	Socket bits for PHILLIPS® screws 1/4" PH	1-2
2	Socket bits for POZIDRIV® screws 1/4" PZ	1-2
2	Socket bits for slot-head screws 1/4"	0,6x4-1,2x7
4	Socket bits for hexagonal screws 1/4"	3-4-5-6
7	socket bits for TORX® screws 1/4" T8-T10-T15-T20-T25-T27-T30	
2	Extensions 1/4" 50-100	
1	Universal joint 1/4"	
1	Sliding T-handle 1/4"	
17	Hexagonal sockets 1/2" 10-11-12-13-14-15-16-17-18-19-20-21-22-24-27-30-32	
6	Long hexagonal sockets 1/2" 13-14-15-17-19-22	
6	TORX® sockets 1/2" E12-E14-E16-E18-E20-E24	
2	Spark plug sockets 1/2" 16-21	
2	Extensions 1/2" 130-250	
1	Universal joint 1/2"	
1	Adapter 1/2-3/8"	
1	Bit-holder socket 1/2-5/16"	
2	Bits 5/16" for slot-head screws 8-12	
2	Bits 5/16" for PHILLIPS® screws PH 3-4	
2	bits 5/16" for POZIDRIV® screws PZ 3-4	
4	Bits 5/16" for TORX® T40-T45-T50-T55	
4	Bits 5/16" for hexagonal screws 8-10-12-14	
4	Bits 5/16" for XZN 6-8-10-12	

LxPxH mm	kg	code	
565x415x45	8	U05190601	1



**519 M 612EESI**  
Bi-colour foam module with assortment (12 pcs.)

- Suitable only for drawers with height 130-200-270 mm

pcs	description	item/size
8	Hexagonal sockets, inch sizes / 1 3/16-2-2 3/16-2 3/8-2 5/8-2 3/4-3-3 1/8	235 1 EPN
2	Extensions	236 1/200-415
1	Reversible ratchet	237 1 SI
1	T-handle with sliding square drive	240 1 N
1	Bi-colour foam module (empty)	519 M 612ESV

LxPxH mm	kg	code	
565x415x110	22	U05190994	1



**519 M 612ESV**  
Bi-colour foam module (empty)

- For assortment 519 M 612ESI - 519 M 612EESI  
- Suitable only for drawers with height 130-200-270 mm

pcs	description	item/size
8	Hexagonal sockets/ 46-50-55-60-65-70-75-80	235 1 EN
2	Extensions	236 1/200-415
1	Reversible ratchet	237 1 SI
1	T-handle with sliding square drive	240 1 N
1	Bi-colour foam module (empty)	519 M 612ESV

LxPxH mm	kg	code	
565x415x110	22,5	U05190993	1

**519 M 612ESV**  
Bi-colour foam module (empty)

- For assortment 519 M 612ESI - 519 M 612EESI  
- Suitable only for drawers with height 130-200-270 mm

LxPxH mm	code	
565x415x110	U05190993Q	1



**519 M 928S12**  
Bi-colour foam module with assortment (12 pcs.)

- Suitable only for drawers with height 130-200-270 mm

pcs	description	item/size
8	Impact hexagonal sockets / 17-19-22-24-27-30-32-36	235 3/4 M
1	Lock pins	235 MCA/8
1	Safety rings	235 MDA/8
1	Impact extensions	236 3/4 M/250
1	Aluminium impact wrench	928 D1 3/4
1	Bi-colour foam module (empty)	519 M 928SV

LxPxH mm	kg	code	
565x415x110	11,3	U05191040	1



**519 M 928S19**  
Bi-colour foam module with assortment (19 pcs.)

- Suitable only for drawers with height 130-200-270 mm

pcs	description	item/size
8	Impact hexagonal sockets / 17-19-22-24-27-30-32-36	235 3/4 M
7	Long impact hexagonal sockets with thin walls /22-24-27-30-32-33-36	235 3/4 MLS
1	Lock pins	235 MCA/8
1	Safety rings	235 MDA/8
1	Impact extensions	236 3/4 M/250
1	Aluminium impact wrench	928 D1 3/4
1	Bi-colour foam module (empty)	519 M 928SV

LxPxH mm	kg	code	
565x415x110	15,5	U05191041	1

**519 M 928SV**  
Bi-colour foam module (empty)

- For assortment 519 M 928S12, 519 M 928S19  
- Suitable only for drawers with height 130-200-270 mm

LxPxH mm	code	
565x415x110	U05191000Q	1



**519 M 235CPV**  
Bi-colour foam module with assortment (15 pcs.)

pcs	description	item/size
15	Bihexagonal sockets, inch sizes / 3/8-7/16-1/2-9/16-5/8-11/16-3/4-13/16-7/8-15/16-1 1/16-1 1/8-1 3/16-1 1/4	235 1/2 PN
1	Bi-colour foam module (empty)	519 M 235CPV

LxPxH mm	code	
188x207x45	U05190972	1

**519 M 235CPV**  
Bi-colour foam module (empty)

- For assortment 519 M 235CP

LxPxH mm	code	
188x207x45	U05190972Q	1





### 531 A

#### Drawer chest - 3 drawers (empty)

- Top with protective rubber
- Centralized security lock
- Side steel handles for transport
- Fixed Aluminum drawer handles
- Telescopic slides with return closing system
- Fully opening drawers
- Sheet steel casing, colour red RAL 3020
- Inside dimensions: 2 drawers 570x270x40 mm; 1 drawer 570x270x60 mm

LxPxH mm	kg	code	
700x345x292	20	U05310001	1



### 531 B

#### Drawer chest - 4 drawers (empty)

- Upper cover with block system of the drawers when cover is closed
- Upper tool compartment (H 60 mm)
- Centralized security lock
- Side steel handles for transport
- Fixed Aluminum drawer handles
- Telescopic slides with return closing system
- Fully opening drawers
- Sheet steel casing, colour red RAL 3020
- Inside dimensions: upper compartment 690x320x60 mm; 3 drawers 570x270x40 mm; 1 drawer 570x270x110 mm

LxPxH mm	kg	code	
700x335x435	23	U05310002	1



### 531 C

#### Drawer chest - 6 drawers (empty)

- Upper cover with block system of the drawers when cover is closed
- Upper tool compartment (H 60 mm)
- Centralized security lock
- Side steel handles for transport
- Fixed Aluminum drawer handles
- Telescopic slides with return closing system
- Fully opening drawers
- Sheet steel casing, colour red RAL 3020
- Inside dimensions: upper compartment 690x320x60 mm; 2 drawers 570x270x40 mm; 1 drawer 570x270x60 mm; 3 drawers 165x270x40 mm

LxPxH mm	kg	code	
700x335x380	30	U05310003	1



### 531 D

#### Drawer chest - 8 drawers (empty)

- Upper cover with block system of the drawers when cover is closed
- Upper tool compartment (H 60 mm)
- Centralized security lock
- Side steel handles for transport
- Fixed Aluminum drawer handles
- Telescopic slides with return closing system
- Fully opening drawers
- Sheet steel casing, colour red RAL 3020
- Inside dimensions: upper compartment 690x320x60 mm; 2 drawers 570x270x40 mm; 1 drawer 570x270x60 mm; 4 drawers 165x270x40 mm; 1 drawer 165x270x90 mm

LxPxH mm	kg	code	
700x335x435	32	U05310004	1



### 532

#### Tool case

- Opening with stop at 95°
- Lock closing hook
- Sheet steel casing, thickness 1,2 mm

size	LxPxH mm	kg	code	
A	520x290x290	6,8	U05320005	1
B	650x350x350	12,5	U05320006	1
C	850x350x350	16	U05320007	1
D	1000x400x450	19	U05320008	1



### 532 R

#### Compartments for tool case

- Removable compartment in enamelled sheet steel

size	for case	LxPxH mm	kg	code	
A	A	390x244x50	1,2	U05320005Q	1
B	B - C	500x306x50	1,6	U05320006Q	1
D	D	500x400x50	1,8	U05320008Q	1



PAGE  
**248**

## BOXES 609 TOP CHOICE

- Compact bimaterial box
- Socket housing with size engraved inside



YouTube



When closed, the box has the same dimensions of a tray for roller cabinets



PAGE  
**235**

## BOXES 604-608 The complete range

- Boxes in high resistance ABS
- Inside tray in plastics (604-607) or in bi-colour foam (608)



YouTube



The inside tray is studied to be modular and can be stored in USAG roller cabinet drawers



PAGE  
**234**

## BOXES 601 Quality and convenience

- Preformed plastic box
- Metal closing clip















































YouTube



The boxes are modular with USAG roller cabinet drawers

# Assortments of sockets

	1/4"	3/8"	1/2"	3/4"	1"	1/4"-1/2"
 <b>601</b> <i>Just</i> <b>USAG</b>	 34 PIECES		 22 PIECES			 82 PIECES 100 PIECES
   <b>604</b>	 14 PIECES	 18 PIECES	 15 PIECES			
  <b>605</b>	 12 PIECES	 20 PIECES	 19 PIECES	 18 PIECES		
   <b>606</b>	 17 PIECES	 21 PIECES	 23 PIECES			 30 PIECES
  <b>607</b>	 44 PIECES		 30 PIECES 49 PIECES			 56 PIECES
 <b>608</b> Inner foam module	 38 PIECES	 20 PIECES	 23 PIECES			
  <b>609</b>	 38 PIECES	 21 PIECES	 21 PIECES			
   <b>612</b> Inner plastic tray or foam module	 19 PIECES	 18 PIECES	 35 PIECES 35 PIECES 23 PIECES	 17 PIECES	 12 PIECES	

 Hexagonal sockets  
  Bihexagonal sockets  
  Sockets in inches

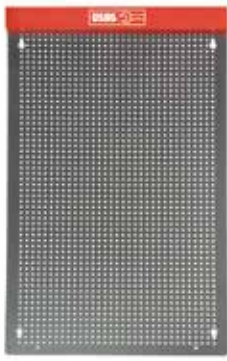

### 545 PT

#### Perforated panel

- Hole diameter 5 mm
- Enamelled sheet steel; thickness 1,2 mm
- Combinable with screw-hooks code 552÷559
- Combinable with hooks for display stands

LxPxH mm	kg	code	
459x1,2x740	3,5	U05450001	1



### 545 V

#### Tray for panel

- Enamelled sheet steel



LxPxH mm	kg	code	
445x27x140	938	U05450003	1



### 552 DV

#### Straight adjustable hooks

- Phosphatised steel

L mm	kg	code	
40	15	U05520181	50
80	23	U05520182	50
100	27	U05520183	50
170	40	U05520184	50



### 552 V

#### Bent adjustable hooks

- Phosphatised steel

L mm	kg	code	
40	16	U05520081	50
80	24	U05520082	50
100	27	U05520083	50
170	40	U05520084	50



### 553 V

#### Bent hooks

- Phosphatised steel

L mm	kg	code	
80	26	U05530181	50
170	41	U05530182	50



### 554 V

#### Bent hook

- Phosphatised steel

L mm	kg	code	
30	19	U05540181	50



### 555 V

#### Half-bent hook

- Phosphatised steel

L mm	kg	code	
45	22	U05550181	50



### 557 V

#### Spring hooks

- Phosphatised steel

n°	capacity mm	kg	code	
1	6÷8	11	U05570181	50
2	9÷11	13	U05570182	50
3	12÷16	13	U05570183	50
4	17÷22	14	U05570184	50
5	23÷29	20	U05570185	20
6	30÷37	23	U05570186	20
7	38÷48	23	U05570187	20



### 559

#### Plastic stands for sockets

- Plastic material

"	kg	code	
3/8	3	U05590013	25
1/2	3	U05590012	50
3/4	10	U05590011	25



### 559 B

#### Metal holders

- For 559 plastic stands
- Enamelled steel sheet

L mm	kg	code	
170	40	U05590014	1
250	65	U05590015	1
500	130	U05590016	1



1/2



Just USAG

### 601 1/2" J22

#### Assortment with hexagonal sockets in modular box (22 pcs.)

- Compact plastic box
- Ergonomic integrated handle
- Double metal closing clip
- 1/2" reversible ratchet with 72 teeth and socket releasing button
- CLOSED has the same dimensions of 1 module
- OPEN has the same dimensions of 2 modules

#### pcs description

17	Hexagonal sockets 1/2" 8-10-11-12-13-14-15-16-17-18-19-21-22-24-27-30-32 mm
2	Extensions 1/2" 130-250 mm
1	Reversible ratchet 1/2"
1	T-handle 1/2"
1	Universal joint 1/2"

LxPxH mm	kg	code	
375x186x80	4	U06010003	1



1/4



Just USAG

### 601 1/4" J34

#### Assortment with hexagonal sockets and bits in modular box (34 pcs.)

- Compact plastic box
- Metal closing clip
- 1/4" reversible ratchet with 72 teeth and socket releasing button
- CLOSED can be stored in h 60mm drawer
- OPEN has the same dimensions of 1 module

#### pcs description

13	Hexagonal sockets 1/4" 4-4,5-5-5,5-6-7-8-9-10-11-12-13-14 mm
2	Extensions 1/4" 55-100 mm
1	Reversible ratchet 1/4"
1	Spinner with handle 1/4"
1	Universal joint 1/4"
1	Bit-holder socket 1/4-1/4"
3	Bits for slot-head screws 1/4" 4-5,5-6
3	Bits for PHILLIPS® screws 1/4" PH 1-2-3
3	Bits for hexagonal screws 1/4" 4-5-6 mm
6	TORX® bits 1/4" T10-T15-T20-T25-T30-T40

LxPxH mm	kg	code	
190x144x58	1	U06010001	1



1/4 1/2

Just **USAG**

**601 1/4"-1/2" J100**

- Plastic box
- Ergonomic integrated handle
- Double metal closing clip
- 1/4" and 1/2" reversible ratchets with 72 teeth and socket releasing button
- CLOSED has the same dimensions of 1 1/2 module
- OPEN takes up the space of 1 drawer (3 modules)

pcs description

Table listing 12 pcs: Hexagonal sockets 1/4", Long hexagonal sockets 1/4", TORX sockets 1/2", Socket bits for PHILLIPS screws 1/4", Socket bits for POZIDRIV screws 1/4", Socket bits for slot-head screws 1/4", Socket bits for hexagonal screws 1/4", Socket bits for TORX screws 1/4", Extensions 1/4", Universal joint 1/4", Sliding T-handle 1/4", Socket-holder 1/4", Reversible ratchet 1/4", Hexagonal sockets 1/2", Long hexagonal sockets 1/2", TORX sockets 1/2", Spark plug sockets 1/2", Extensions 1/2", Universal joint 1/2", Reversible ratchet 1/2", Adapter 1/2-3/8", Bit-holder socket 1/2"-5/16", Bits 5/16" for slot-head screws 8-12 mm, Bits 5/16" for PHILLIPS screws PH 3-4, Bits 5/16" for POZIDRIV screws PZ 3-4, Bits 5/16" for TORX T40-T45-T50-T55, Bits 5/16" for hexagonal screws 8-10-12-14 mm, Bits 5/16" for XZN 6-8-10-12

Summary table for 601 1/4"-1/2" J100: LxPxH mm (415x283x92), Kg (8), code (U06010011), 1



1/4 1/2

Just **USAG**

**601 1/4"-1/2" J82**

**Assortment with hexagonal sockets and combination wrenches in modular box (82 pcs.)**

- Plastic box
- Ergonomic integrated handle
- Double metal closing clip
- 1/4"-1/2" reversible ratchets with 72 teeth and socket releasing button
- CLOSED has the same dimensions of 1 1/2 module
- OPEN it takes up the space of 1 drawer (3 modules)

pcs description

Table listing 13 pcs: Combination wrenches 8-10-11-12-13-14-17-19-22 mm, Hexagonal sockets 1/4", Extensions 1/4", Flexible extension 150 mm, Reversible ratchet 1/4", Spinner with handle 1/4", Universal joint 1/4", T-handle 1/4", Bit-holder socket 1/4-1/4", Socket bits for slot-head screws 1/4", Socket bits for PHILLIPS screws 1/4", Socket bits for POZIDRIV screws 1/4", Socket bits for hexagonal screws 1/4", Socket bits for TORX screws 1/4", Hexagonal sockets 1/2", Spark plug sockets 1/2", Extensions 1/2", Reversible ratchet 1/2", Universal joint 1/2", Bit-holder socket 1/2"-5/16", Adapter 1/2"-3/8", Bits for slot-head screws 1/4", Bits for PHILLIPS screws 1/4", Bits for POZIDRIV screws 1/4", Bits for slot-head screws 1/4", TORX bits 1/4"

Summary table for 601 1/4"-1/2" J82: LxPxH mm (415x283x92), Kg (7), code (U06010010), 1



1/4 1/2

Just **USAG**

**601 1/4"-1/2" JTX16**

**Assortment with TORX sockets in modular box (16 pcs.)**

- Compact plastic box
- Metal closing clip
- CLOSED can be stored in a drawer h 60 mm
- OPEN has the same dimensions of 1 module
- Contents:
4 TORX sockets 1/4" E6-E7-E8-E10
4 TORX sockets 1/2" E12-E14-E16-E18
4 TORX socket bits 1/4" T10-T15-T20-T25
4 TORX socket bits 1/2" T30-T40-T45-T50

Summary table for 601 1/4"-1/2" JTX16: LxPxH mm (190x138x58), Kg (1), code (U06010009), 1



1/4

**604 1/4" E**

**Assortment with hexagonal sockets in ABS case (14 pcs.)**

- High resistance ABS case with quick closing system
- The inside tray is studied to be stored in USAG roller cabinet drawers
- Empty inner plastic tray: code U06040100Q

Table listing 11 pcs: Hexagonal sockets / 4-5-5.5-6-7-8-9-10-11-12-13, Extensions, T-handle with sliding square drive, Spinner with handle, Empty ABS case - size S

Summary table for 604 1/4" E: LxPxH mm (210x130x60), Kg (700), code (U06040101), 1

The workshop is served.



Just **USAG**

USAG quality at a Just prize



YouTube



1/4

### 604 1/4" POL

#### Assortment with hexagonal sockets in ABS case, in inches (14 pcs.)

- High resistance ABS case with quick closing system
- The inside tray is studied to be stored in USAG roller cabinet drawers
- Empty inner plastic tray: code U06040100Q

pcs	description	item/size
11	Hexagonal sockets, inch sizes / 5/32-3/16-7/32-1/4-9/32-5/16-11/32-3/8-7/16-1/2-9/16	235 1/4 EPN
1	Extensions	236 1/4/100
1	T-handle with sliding square drive	240 1/4
1	Spinner with handle	243 1/4
1	Empty ABS case - size S	606 S

LxPxH mm	kg	code	
210x130x60	700	U06040102	1



3/8

### 604 3/8" EA

#### Assortment with hexagonal sockets in ABS case (18 pcs.)

- High resistance ABS case with quick closing system
- The inside tray is studied to be stored in USAG roller cabinet drawers
- Empty inner plastic tray: code U05190711Q

pcs	description	item/size
14	Hexagonal sockets /8-9-10-11-12-13-14-15-16-17-18-19-21-22	235 3/8 E
2	Extensions/125-250	236 3/8
1	Reversible ratchet with sealed mechanism (certified IP51)	237 A 3/8
1	Universal joint	241 3/8
1	Empty ABS case - size M	606 M

LxPxH mm	kg	code	
330x215x60	2	U06040202	1



3/8

### 604 3/8" EB

#### Assortment with hexagonal sockets in ABS case (18 pcs.)

- High resistance ABS case with quick closing system
- The inside tray is studied to be stored in USAG roller cabinet drawers
- Empty inner plastic tray: code U05190711Q

pcs	description	item/size
14	Hexagonal sockets /8-9-10-11-12-13-14-15-16-17-18-19-21-22	235 3/8 E
2	Extensions/125-250	236 3/8
1	Reversible ratchet with sealed mechanism	237 B 3/8
1	Universal joint	241 3/8
1	Empty ABS case - size M	606 M

LxPxH mm	kg	code	
330x215x60	2	U06040204	1



3/8

### 604 3/8" A

#### Assortment with bihexagonal sockets in ABS case (18 pcs.)

- High resistance ABS case with quick closing system
- The inside tray is studied to be stored in USAG roller cabinet drawers
- Empty inner plastic tray: code U05190711Q

pcs	description	item/size
14	Bihexagonal sockets /8-9-10-11-12-13-14-15-16-17-18-19-21-22	235 3/8
2	Extensions/125-250	236 3/8
1	Reversible ratchet with sealed mechanism (certified IP51)	237 A 3/8
1	Universal joint	241 3/8
1	Empty ABS case - size M	606 M

LxPxH mm	kg	code	
330x215x60	1,8	U06040201	1



3/8

### 604 3/8" B

#### Assortment with bihexagonal sockets in ABS case (18 pcs.)

- High resistance ABS case with quick closing system
- The inside tray is studied to be stored in USAG roller cabinet drawers
- Empty inner plastic tray: code U05190711Q

pcs	description	item/size
14	Bihexagonal sockets /8-9-10-11-12-13-14-15-16-17-18-19-21-22	235 3/8
2	Extensions/125-250	236 3/8
1	Reversible ratchet with sealed mechanism	237 B 3/8
1	Universal joint	241 3/8
1	Empty ABS case - size M	606 M

LxPxH mm	kg	code	
330x215x60	2	U06040203	1



1/2

### 604 1/2" A

#### Assortment with bihexagonal sockets in ABS case (15 pcs.)

- High resistance ABS case with quick closing system
- The inside tray is studied to be stored in USAG roller cabinet drawers
- Empty inner plastic tray: code U06040300Q

pcs	description	item/size
13	Bihexagonal sockets /10-11-12-13-14-15-16-17-18-19-21-22-24	235 1/2 N
1	Extensions	236 1/2/125
1	Reversible ratchet with sealed mechanism (certified IP51)	237 A 1/2
1	Empty ABS case - size M	606 M

LxPxH mm	kg	code	
330x215x60	2	U06040301	1



1/2

### 604 1/2" EA

#### Assortment with hexagonal sockets in ABS case (15 pcs.)

- High resistance ABS case with quick closing system
- The inside tray is studied to be stored in USAG roller cabinet drawers
- Empty inner plastic tray: code U06040300Q

pcs	description	item/size
13	Hexagonal sockets /10-11-12-13-14-15-16-17-18-19-21-22-24	235 1/2 EN
1	Extensions	236 1/2/125
1	Reversible ratchet with sealed mechanism (certified IP51)	237 A 1/2
1	Empty ABS case - size M	606 M

LxPxH mm	kg	code	
330x215x60	2	U06040302	1



1/2

### 604 1/2" EB

#### Assortment with hexagonal sockets in ABS case (15 pcs.)

- High resistance ABS case with quick closing system
- The inside tray is studied to be stored in USAG roller cabinet drawers
- Empty inner plastic tray: code U06040300Q

pcs	description	item/size
13	Hexagonal sockets /10-11-12-13-14-15-16-17-18-19-21-22-24	235 1/2 EN
1	Extensions	236 1/2/125
1	Reversible ratchet with sealed mechanism	237 B 1/2
1	Empty ABS case - size M	606 M

LxPxH mm	kg	code	
330x215x60	2	U06040304	1



1/2

### 604 1/2" ED

#### Assortment with hexagonal sockets in ABS case (15 pcs.)

- High resistance ABS case with quick closing system
- The inside tray is studied to be stored in USAG roller cabinet drawers
- Empty inner plastic tray: code U06040300Q

pcs	description	item/size
13	Hexagonal sockets /10-11-12-13-14-15-16-17-18-19-21-22-24	235 1/2 EN
1	Extensions	236 1/2/125
1	Sliding square ratchet	237 D 1/2
1	Empty ABS case - size M	606 M

LxPxH mm	kg	code	
330x215x60	2	U06040300	1



1/2

### 604 1/2" B

#### Assortment with bihexagonal sockets in ABS case (15 pcs.)

- High resistance ABS case with quick closing system
- The inside tray is studied to be stored in USAG roller cabinet drawers
- Empty inner plastic tray: code U06040300Q

pcs	description	item/size
13	Bihexagonal sockets /10-11-12-13-14-15-16-17-18-19-21-22-24	235 1/2 N
1	Extensions	236 1/2/125
1	Reversible ratchet with sealed mechanism	237 B 1/2
1	Empty ABS case - size M	606 M

LxPxH mm	kg	code	
330x215x60	2	U06040303	1



1/2

### 604 1/2" EAK

#### Assortment with hexagonal sockets in ABS case (15 pcs.)

- High resistance ABS case with quick closing system
- The inside tray is studied to be stored in USAG roller cabinet drawers
- Empty inner plastic tray: code U06040300Q

pcs	description	item/size
13	Hexagonal sockets /10-11-12-13-14-15-16-17-18-19-21-22-24	235 1/2 EN
1	Extensions	236 1/2/125
1	Reversible ratchet with revolving handle	237 1/2 AK
1	Empty ABS case - size M	606 M

LxPxH mm	kg	code	
330x215x60	2	U06040305	1



1/4

### 605 1/4" EA

#### Assortment with hexagonal sockets, in inches, in ABS case (12 pcs.)

- High resistance ABS case with quick closing system
- The inside tray is studied to be stored in USAG roller cabinet drawers
- Empty inner plastic tray: code U05190738Q

pcs	description	item/size
9	Hexagonal sockets /5,5-6-7-8-9-10-11-12-13	235 1/4 EN
1	Extensions	236 1/4/100
1	Reversible ratchet with sealed mechanism (certified IP51)	237 A 1/4
1	Spinner with handle	243 1/4
1	Empty ABS case - size S	606 S

LxPxH mm	gr	code	
210x130x60	600	U06050101	1



**1/4**  
**605 1/4" EB**

**Assortment with hexagonal sockets in ABS case (12 pcs.)**

- High resistance ABS case with quick closing system
- The inside tray is studied to be stored in USAG roller cabinet drawers
- Empty inner plastic tray: code U05190738Q

pcs	description	item/size
9	Hexagonal sockets / 5,5-6-7-8-9-10-11-12-13	235 1/4 EN
1	Extensions	236 1/4/100
1	Reversible ratchet with sealed mechanism	237 B 1/4
1	Spinner with handle	243 1/4
1	Empty ABS case - size S	606 S

LxPxH mm	kg	code	img
210x130x60	600	U06050102	1



**3/8**  
**605 3/8" A**

**Assortment with bihexagonal sockets in ABS case (20 pcs.)**

- High resistance ABS case with quick closing system
- The inside tray is studied to be stored in USAG roller cabinet drawers
- Empty inner plastic tray: code U05190743Q

pcs	description	item/size
15	Bihexagonal sockets /7-8-9-10-11-12-13-14-15-16-17-18-19-21-22	235 3/8
2	Extensions /125-250	236 3/8
1	Reversible ratchet with sealed mechanism (certified IP51)	237 A 3/8
1	T-handle with sliding square drive	240 3/8 N
1	Universal joint	241 3/8
1	Empty ABS case - size M	606 M

LxPxH mm	kg	code	img
330x215x60	2	U06050205	1



**3/8**  
**605 3/8" B**

**Assortment with bihexagonal sockets in ABS case (20 pcs.)**

- High resistance ABS case with quick closing system
- The inside tray is studied to be stored in USAG roller cabinet drawers
- Empty inner plastic tray: code U05190743Q

pcs	description	item/size
15	Bihexagonal sockets /7-8-9-10-11-12-13-14-15-16-17-18-19-21-22	235 3/8
2	Extensions /125-250	236 3/8
1	Reversible ratchet with sealed mechanism	237 B 3/8
1	T-handle with sliding square drive	240 3/8 N
1	Universal joint	241 3/8
1	Empty ABS case - size M	606 M

LxPxH mm	kg	code	img
330x215x60	2,1	U06050207	1



**1/4**  
**605 1/4" ED**

**Assortment with hexagonal sockets in ABS case (12 pcs.)**

- High resistance ABS case with quick closing system
- The inside tray is studied to be stored in USAG roller cabinet drawers
- Empty inner plastic tray: code U05190738Q

pcs	description	item/size
9	Hexagonal sockets / 5,5-6-7-8-9-10-11-12-13	235 1/4 EN
1	Extensions	236 1/4/100
1	Sliding square ratchet	237 D 1/4
1	Spinner with handle	243 1/4
1	Empty ABS case - size S	606 S

LxPxH mm	gr	code	img
210x130x60	600	U06050100	1



**3/8**  
**605 3/8" EA**

**Assortment with hexagonal sockets in ABS case (20 pcs.)**

- High resistance ABS case with quick closing system
- The inside tray is studied to be stored in USAG roller cabinet drawers
- Empty inner plastic tray: code U05190743Q

pcs	description	item/size
15	Hexagonal sockets /7-8-9-10-11-12-13-14-15-16-17-18-19-21-22	235 3/8 E
2	Extensions /125-250	236 3/8
1	Reversible ratchet with sealed mechanism	237 B 3/8
1	T-handle with sliding square drive	240 3/8 N
1	Universal joint	241 3/8
1	Empty ABS case - size M	606 M

LxPxH mm	kg	code	img
330x215x60	2	U06050206	1



**3/8**  
**605 3/8" EB**

**Assortment with hexagonal sockets in ABS case (20 pcs.)**

- High resistance ABS case with quick closing system
- The inside tray is studied to be stored in USAG roller cabinet drawers
- Empty inner plastic tray: code U05190743Q

pcs	description	item/size
15	Hexagonal sockets /7-8-9-10-11-12-13-14-15-16-17-18-19-21-22	235 3/8 E
2	Extensions /125-250	236 3/8
1	Reversible ratchet with sealed mechanism	237 B 3/8
1	T-handle with sliding square drive	240 3/8 N
1	Universal joint	241 3/8
1	Empty ABS case - size M	606 M

LxPxH mm	kg	code	img
330x215x60	2,1	U06050208	1





1/2

### 605 1/2" A

#### Assortment with bihexagonal sockets in ABS case (19 pcs.)

- High resistance ABS case with quick closing system
- The inside tray is studied to be stored in USAG roller cabinet drawers
- Empty inner plastic tray: code U05190759Q

pcs	description	item/size
16	Bihexagonal sockets /10-11-12-13-14-15-16-17-18-19-21-22-24-27-30-32	235 1/2 N
1	Extensions	236 1/2/125
1	Reversible ratchet with sealed mechanism (certified IP51)	237 A 1/2
1	Universal joint	241 1/2
1	Empty ABS case - size M	606 M

LxPxH mm	kg	code	
330x215x60	2,8	U06050301	1



1/2

### 605 1/2" B

#### Assortment with bihexagonal sockets in ABS case (19 pcs.)

- High resistance ABS case with quick closing system
- The inside tray is studied to be stored in USAG roller cabinet drawers
- Empty inner plastic tray: code U05190759Q

pcs	description	item/size
16	Bihexagonal sockets / 10-11-12-13-14-15-16-17-18-19-21-22-24-27-30-32	235 1/2 N
1	Extensions	236 1/2/125
1	Reversible ratchet with sealed mechanism	237 B 1/2
1	Universal joint	241 1/2
1	Empty ABS case - size M	606 M

LxPxH mm	kg	code	
330x215x60	3	U06050303	1



3/4

### 605 3/4" A

#### Assortment with bihexagonal sockets in ABS case (18 pcs.)

- Storable in the drawers of USAG roller cabinets

pcs	description	item/size
13	Bihexagonal sockets /19-21-22-24-27-30-32-34-36-41-46-50-55	235 3/4 N
2	Extensions/200-400	236 3/4
1	Reversible ratchet	237 A 3/4
1	T-handle with sliding square drive	240 3/4 N
1	Universal joint	241 3/4

LxPxH mm	kg	code	
565x415x100	15	U06050209	1



1/2

### 605 1/2" EA

#### Assortment with hexagonal sockets in ABS case (19 pcs.)

- High resistance ABS case with quick closing system
- The inside tray is studied to be stored in USAG roller cabinet drawers
- Empty inner plastic tray: code U05190759Q

pcs	description	item/size
16	Hexagonal sockets /10-11-12-13-14-15-16-17-18-19-21-22-24-27-30-32	235 1/2 EN
1	Extensions	236 1/2/125
1	Reversible ratchet with sealed mechanism (certified IP51)	237 A 1/2
1	Universal joint	241 1/2
1	Empty ABS case - size M	606 M

LxPxH mm	kg	code	
330x215x60	3	U06050302	1



1/2

### 605 1/2" EB

#### Assortment with hexagonal sockets in ABS case (19 pcs.)

- High resistance ABS case with quick closing system
- The inside tray is studied to be stored in USAG roller cabinet drawers
- Empty inner plastic tray: code U05190759Q

pcs	description	item/size
16	Hexagonal sockets / 10-11-12-13-14-15-16-17-18-19-21-22-24-27-30-32	235 1/2 EN
1	Extensions	236 1/2/125
1	Reversible ratchet with sealed mechanism	237 B 1/2
1	Universal joint	241 1/2
1	Empty ABS case - size M	606 M

LxPxH mm	kg	code	
330x215x60	3	U06050304	1



3/4

### 605 3/4" EA

#### Assortment with hexagonal sockets in ABS case (18 pcs.)

- Storable in the drawers of USAG roller cabinets

pcs	description	item/size
13	Hexagonal sockets /19-21-22-24-27-30-32-34-36-41-46-50-55	235 3/4 EN
2	Extensions/200-400	236 3/4
1	Reversible ratchet	237 A 3/4
1	T-handle with sliding square drive	240 3/4 N
1	Universal joint	241 3/4

LxPxH mm	kg	code	
565x415x100	15	U06050210	1



3/4

### 605 3/4" B

#### Assortment with bihexagonal sockets in ABS case (18 pcs)

- Storable in the drawers of USAG roller cabinets

pcs	description	item/size
13	Bihexagonal sockets /19-21-22-24-27-30-32-34-36-41-46-50-55	235 3/4 N
2	Extensions/200-400	236 3/4
1	Reversible ratchet with sealed mechanism	237 B 3/4
1	T-handle with sliding square drive	240 3/4 N
1	Universal joint	241 3/4

LxPxH mm	kg	code	
415x565x100	15	U06050211	1



1/4

### 606 1/4" SK

#### Assortment with bits and reversible ratchet (31 pcs.)

pcs	description	item/size
2	Bits for slot-head screws -1/4" / 0,5x4-1x5,5	660
9	Bits for hex socket screws -1/4" / 1,5-2-2,5-3-4-5-6-7-8	660 E
3	Bits for PHILLIPS® screws -1/4" / 1-2-3	660 PH
3	Bits for POZIDRIV® - SUPADRIV® screws -1/4" / 1-2-3	660 PZ
1	Socket-holder bit -1/4"	660 Q
7	Bits for TORX® Tamper Resistant screws -1/4" / T10-T15-T20-T25-T27-T30-T40	660 STX
4	Bits for TORX® screws -1/4" / T6-T7-T8-T9	660 TX
1	Magnetic bit-holder adapter - 1/4"	672 MG

LxPxH mm	kg	code	
120x60x30	350	U06060012	1



1/4 1/2

### 606 1/4"-1/2" EA

#### Assortment with hexagonal sockets in ABS case (30 pcs.)

- High resistance ABS case with quick closing system  
 - The inside tray is studied to be stored in USAG roller cabinet drawers  
 - Empty inner plastic tray: code U05190803Q

pcs	description	item/size
14	Hexagonal sockets /10-11-12-13-14-15-16-17-18-19-21-22-24-27	235 1/2 EN
9	Hexagonal sockets / 5,5-6-7-8-9-10-11-12-13	235 1/4 EN
1	Extensions	236 1/2/125
1	Extensions	236 1/4/100
1	Reversible ratchet with sealed mechanism (certified IP51)	237 A 1/2
1	Reversible ratchet with sealed mechanism (certified IP51)	237 A 1/4
1	Universal joint	241 1/2
1	Universal joint	241 1/4
1	Spinner with handle	243 1/4
1	Empty ABS case - size M	606 M

LxPxH mm	kg	code	
330x215x60	3	U06060312	1



1/4 1/2

### 606 1/4"-1/2" EB

#### Assortment with hexagonal sockets in ABS case (30 pcs.)

- High resistance ABS case with quick closing system  
 - The inside tray is studied to be stored in USAG roller cabinet drawers  
 - Empty inner plastic tray: code U05190803Q

pcs	description	item/size
14	Hexagonal sockets / 10-11-12-13-14-15-16-17-18-19-21-22-24-27	235 1/2 EN
9	Hexagonal sockets / 5,5-6-7-8-9-10-11-12-13	235 1/4 EN
1	Extensions	236 1/2/125
1	Extensions	236 1/4/100
1	Reversible ratchet with sealed mechanism	237 B 1/2
1	Reversible ratchet with sealed mechanism	237 B 1/4
1	Universal joint	241 1/2
1	Universal joint	241 1/4
1	Spinner with handle	243 1/4
1	Empty ABS case - size M	606 M

LxPxH mm	kg	code	
330x215x60	3	U06060314	1



3/4

### 605 3/4" EB

#### Assortment with hexagonal sockets in ABS case (18 pcs.)

- Storable in the drawers of USAG roller cabinets

pcs	description	item/size
13	Hexagonal sockets /19-21-22-24-27-30-32-34-36-41-46-50-55	235 3/4 EN
2	Extensions/200-400	236 3/4
1	Reversible ratchet with sealed mechanism	237 B 3/4
1	T-handle with sliding square drive	240 3/4 N
1	Universal joint	241 3/4

LxPxH mm	kg	code	
415x565x100	15	U06050212	1



1/4

### 606 1/4" EA

#### Assortment with hexagonal sockets in ABS case (19 pcs.)

- High resistance ABS case with quick closing system  
 - The inside tray is studied to be stored in USAG roller cabinet drawers  
 - Empty inner plastic tray: code U06060100Q

pcs	description	item/size
13	Hexagonal sockets /4-4,5-5-5,5-6-7-8-9-10-11-12-13-14	235 1/4 EN
2	Extensions/50-100	236 1/4
1	Reversible ratchet with sealed mechanism (certified IP51)	237 A 1/4
1	T-handle with sliding square drive	240 1/4
1	Universal joint	241 1/4
1	Spinner with handle	243 1/4
1	Empty ABS case - size S	606 S

LxPxH mm	kg	code	
210x130x60	1	U06060101	1



1/4

### 606 1/4" APOL

#### Assortment with hexagonal sockets in ABS case, in inches (18 pcs.)

- High resistance ABS case with quick closing system
- The inside tray is studied to be stored in USAG roller cabinet drawers
- Empty inner plastic tray: code U06060100Q



pcs	description	item/size
12	Hexagonal sockets, inch sizes /1/8-5/32-3/16-7/32-1/4-9/32-5/16-11/32-3/8-7/16-1/2-9/16	235 1/4 EPN
2	Extensions/50-100	236 1/4
1	Reversible ratchet with sealed mechanism (certified IP51)	237 A 1/4
1	T-handle with sliding square drive	240 1/4
1	Universal joint	241 1/4
1	Spinner with handle	243 1/4
1	Empty ABS case - size S	606 S

LxPxH mm	kg	code	
210x130x60	1	U06060104	1



1/4

### 606 1/4" EB

#### Assortment with hexagonal sockets in ABS case (19 pcs.)

- High resistance ABS case with quick closing system
- The inside tray is studied to be stored in USAG roller cabinet drawers
- Empty inner plastic tray: code U06060100Q



pcs	description	item/size
13	Hexagonal sockets / 4-4,5-5-5,5-6-7-8-9-10-11-12-13-14	235 1/4 EN
2	Extensions/50-100	236 1/4
1	Reversible ratchet with sealed mechanism	237 B 1/4
1	T-handle with sliding square drive	240 1/4
1	Universal joint	241 1/4
1	Spinner with handle	243 1/4
1	Empty ABS case - size S	606 S

LxPxH mm	kg	code	
210x130x60	1	U06060102	1



1/4

### 606 1/4" EAK

#### Assortment with hexagonal sockets in ABS case (19 pcs.)

- High resistance ABS case with quick closing system
- The inside tray is studied to be stored in USAG roller cabinet drawers
- Empty inner plastic tray: code U06060100Q



pcs	description	item/size
13	Hexagonal sockets /4-4,5-5-5,5-6-7-8-9-10-11-12-13-14	235 1/4 EN
2	Extensions/50-100	236 1/4
1	Reversible ratchet with revolving handle	237 1/4 AK
1	T-handle with sliding square drive	240 1/4
1	Universal joint	241 1/4
1	Spinner with handle	243 1/4
1	Empty ABS case - size S	606 S

LxPxH mm	kg	code	
210x130x60	1	U06060103	1



1/4

### 606 1/4" AEPOL

#### Assortment with hexagonal sockets in ABS case (28 pcs.)

- High resistance ABS case with quick closing system
- The inside tray is studied to be stored in USAG roller cabinet drawers
- Empty inner plastic tray: code U05190801Q



pcs	description	item/size
12	Hexagonal sockets /4-5-5,5-6-7-8-9-10-11-12-13-14	235 1/4 EN
11	Hexagonal sockets, inch sizes /5/32-3/16-7/32-1/4-9/32-5/16-11/32-3/8-7/16-1/2-9/16	235 1/4 EPN
2	Extensions/50-150	236 1/4
1	Reversible ratchet with sealed mechanism (certified IP51)	237 A 1/4
1	Universal joint	241 1/4
1	Spinner with handle	243 1/4
1	Empty ABS case - size S	606 S

LxPxH mm	code	
210x130x60	U06060106	1



1/4

### 606 1/4" BPOL

#### Assortment with hexagonal sockets in ABS case, in inches (18 pcs.)

- High resistance ABS case with quick closing system
- The inside tray is studied to be stored in USAG roller cabinet drawers
- Empty inner plastic tray: code U06060100Q



pcs	description	item/size
12	Hexagonal sockets, inch sizes /1/8-5/32-3/16-7/32-1/4-9/32-5/16-11/32-3/8-7/16-1/2-9/16	235 1/4 EPN
2	Extensions /50-100	236 1/4
1	Reversible ratchet with sealed mechanism	237 B 1/4
1	T-handle with sliding square drive	240 1/4
1	Universal joint	241 1/4
1	Spinner with handle	243 1/4
1	Empty ABS case - size S	606 S

LxPxH mm	kg	code	
210x130x60	1	U06060105	1



3/8

### 606 3/8" A

#### Assortment with bihexagonal sockets in ABS case (21 pcs.)

- High resistance ABS case with quick closing system
- The inside tray is studied to be stored in USAG roller cabinet drawers
- Empty inner plastic tray: code U05190346Q



pcs	description	item/size
16	Bihexagonal sockets /6-7-8-9-10-11-12-13-14-15-16-17-18-19-21-22	235 3/8
2	Extensions/125-250	236 3/8
1	Reversible ratchet with sealed mechanism (certified IP51)	237 A 3/8
1	T-handle with sliding square drive	240 3/8 N
1	Universal joint	241 3/8
1	Empty ABS case - size L	606 L

LxPxH mm	kg	code	
435x270x70	1,5	U06060201	1



**3/8**

**606 3/8" EA**

**Assortment with hexagonal sockets in ABS case (21 pcs.)**

- High resistance ABS case with quick closing system
- The inside tray is studied to be stored in USAG roller cabinet drawers
- Empty inner plastic tray: code U05190346Q

pcs	description	item/size
16	Hexagonal sockets /6-7-8-9-10-11-12-13-14-15-16-17-18-19-21-22	235 3/8 E
2	Extensions/125-250	236 3/8
1	Reversible ratchet with sealed mechanism (certified IP51)	237 A 3/8
1	T-handle with sliding square drive	240 3/8 N
1	Universal joint	241 3/8
1	Empty ABS case - size L	606 L

LxPxH mm	kg	code	img
435x270x70	1,5	U06060202	1



**3/8**

**606 3/8" EB**

**Assortment with hexagonal sockets in ABS case (21 pcs.)**

- High resistance ABS case with quick closing system
- The inside tray is studied to be stored in USAG roller cabinet drawers
- Empty inner plastic tray: code U05190346Q

pcs	description	item/size
16	Hexagonal sockets /6-7-8-9-10-11-12-13-14-15-16-17-18-19-21-22	235 3/8 E
2	Extensions/125-250	236 3/8
1	Reversible ratchet with sealed mechanism	237 B 3/8
1	T-handle with sliding square drive	240 3/8 N
1	Universal joint	241 3/8
1	Empty ABS case - size L	606 L

LxPxH mm	kg	code	img
435x270x70	1,5	U06060204	1



**1/2**

**606 1/2" EA**

**Assortment with hexagonal sockets in ABS case (23 pcs.)**

- High resistance ABS case with quick closing system
- The inside tray is studied to be stored in USAG roller cabinet drawers
- Empty inner plastic tray: code U06060300Q

pcs	description	item/size
19	Hexagonal sockets /8-9-10-11-12-13-14-15-16-17-18-19-21-22-23-24-27-30-32	235 1/2 EN
2	Extensions/125-250	236 1/2
1	Reversible ratchet with sealed mechanism (certified IP51)	237 A 1/2
1	Universal joint	241 1/2
1	Empty ABS case - size M	606 M

LxPxH mm	kg	code	img
330x215x60	3	U06060302	1



**3/8**

**606 3/8" B**

**Assortment with bihexagonal sockets in ABS case (21 pcs.)**

- High resistance ABS case with quick closing system
- The inside tray is studied to be stored in USAG roller cabinet drawers
- Empty inner plastic tray: code U05190346Q

pcs	description	item/size
16	Bihexagonal sockets /6-7-8-9-10-11-12-13-14-15-16-17-18-19-21-22	235 3/8
2	Extensions/125-250	236 3/8
1	Reversible ratchet with sealed mechanism	237 B 3/8
1	T-handle with sliding square drive	240 3/8 N
1	Universal joint	241 3/8
1	Empty ABS case - size L	606 L

LxPxH mm	kg	code	img
435x270x70	1,5	U06060203	1



**1/2**

**606 1/2" A**

**Assortment with bihexagonal sockets in ABS case (23 pcs.)**

- High resistance ABS case with quick closing system
- The inside tray is studied to be stored in USAG roller cabinet drawers
- Empty inner plastic tray: code U06060300Q

pcs	description	item/size
19	Bihexagonal sockets /8-9-10-11-12-13-14-15-16-17-18-19-21-22-23-24-27-30-32	235 1/2 N
2	Extensions/125-250	236 1/2
1	Reversible ratchet with sealed mechanism (certified IP51)	237 A 1/2
1	Universal joint	241 1/2
1	Empty ABS case - size M	606 M

LxPxH mm	kg	code	img
330x215x60	3	U06060301	1



**1/2**

**606 1/2" APOL**

**Assortment with bihexagonal sockets in ABS case, in inches (15 pcs.)**

- High resistance ABS case with quick closing system
- The inside tray is studied to be stored in USAG roller cabinet drawers
- Empty inner plastic tray: code U05190798Q

pcs	description	item/size
11	Bihexagonal sockets, inch sizes /3/8-7/16-1/2-9/16-19/32-5/8-21/32-11/16-3/4-13/16-7/8	235 1/2 PN
2	Extensions/125-250	236 1/2
1	Reversible ratchet with sealed mechanism (certified IP51)	237 A 1/2
1	Universal joint	241 1/2
1	Empty ABS case - size M	606 M

LxPxH mm	kg	code	img
330x215x60	2,8	U06060306	1



1/2

### 606 1/2" B

#### Assortment with bihexagonal sockets in ABS case (23 pcs.)

- High resistance ABS case with quick closing system
- The inside tray is studied to be stored in USAG roller cabinet drawers
- Empty inner plastic tray: code U06060300Q

pcs	description	item/size
19	Bihexagonal sockets / 8-9-10-11-12-13-14-15-16-17-18-19-21-22-23-24-27-30-32	235 1/2 N
2	Extensions/125-250	236 1/2
1	Reversible ratchet with sealed mechanism	237 B 1/2
1	Universal joint	241 1/2
1	Empty ABS case - size M	606 M

LxPxH mm	kg	code	1
330x215x60	3	U06060303	1



1/2

### 606 1/2" BPOL

#### Assortment with bihexagonal sockets in ABS case, in inches (15 pcs.)

- High resistance ABS case with quick closing system
- The inside tray is studied to be stored in USAG roller cabinet drawers
- Empty inner plastic tray: code U05190798Q

pcs	description	item/size
11	Bihexagonal sockets, inch sizes 3/8-7/16-1/2-9/16-19/32-5/8-21/32-11/16-3/4-13/16-7/8	235 1/2 PN
2	Extensions/125-250	236 1/2
1	Reversible ratchet with sealed mechanism	237 B 1/2
1	Universal joint	241 1/2
1	Empty ABS case - size M	606 M

LxPxH mm	kg	code	1
330x215x60	2,8	U06060307	1



1/2

### 606 1/2" EAK

#### Assortment with hexagonal sockets in ABS case (23 pcs.)

- High resistance ABS case with quick closing system
- The inside tray is studied to be stored in USAG roller cabinet drawers
- Empty inner plastic tray: code U06060300Q

pcs	description	item/size
19	Hexagonal sockets / 8-9-10-11-12-13-14-15-16-17-18-19-21-22-23-24-27-30-32	235 1/2 EN
2	Extensions/125-250	236 1/2
1	Reversible ratchet with revolving handle	237 1/2 AK
1	Universal joint	241 1/2
1	Empty ABS case - size M	606 M

LxPxH mm	kg	code	1
330x215x60	2	U06060305	1



1/2

### 606 1/2" EB

#### Assortment with hexagonal sockets in ABS case (23 pcs.)

- High resistance ABS case with quick closing system
- The inside tray is studied to be stored in USAG roller cabinet drawers
- Empty inner plastic tray: code U06060300Q

pcs	description	item/size
19	Hexagonal sockets / 8-9-10-11-12-13-14-15-16-17-18-19-21-22-23-24-27-30-32	235 1/2 EN
2	Extensions/125-250	236 1/2
1	Reversible ratchet with sealed mechanism	237 B 1/2
1	Universal joint	241 1/2
1	Empty ABS case - size M	606 M

LxPxH mm	kg	code	1
330x215x60	3	U06060304	1



1/2

### 606 1/2" EBP

#### Assortment with hexagonal sockets in ABS case (23 pcs.)

- High resistance ABS case with quick closing system
- The inside tray is studied to be stored in USAG roller cabinet drawers
- Empty inner plastic tray: code U06060300Q

pcs	description	item/size
19	Hexagonal sockets / 8-9-10-11-12-13-14-15-16-17-18-19-21-22-23-24-27-30-32	235 1/2 EN
2	Extensions/125-250	236 1/2
1	Reversible ratchet with socket retaining system	237 1/2 BP
1	Universal joint	241 1/2
1	Empty ABS case - size M	606 M

LxPxH mm	kg	code	1
330x215x60	3	U06060308	1



### 606 S

#### Empty ABS case - size S

- Closing clip

LxPxH mm	code	1
210x130x60	U0606007Q	1



### 606 M

#### Empty ABS case - size M

- Closing clip

LxPxH mm	code	1
330x215x60	U0606008Q	1



## 606 L

### Empty ABS case - size L

- Closing clip and carrying handle

LxPxH mm	code	
435x270x70	U06060009Q	1



$\frac{1}{4}$

## 607 $\frac{1}{4}$ " EB

### Assortment with hexagonal sockets in ABS case (44 pcs.)

- High resistance ABS case with quick closing system
- The inside tray is studied to be stored in USAG roller cabinet drawers
- Empty inner plastic tray: code U05190353Q

pcs	description	item/size
10	Long hexagonal sockets /5-6-7-8-9-10-11-12-13-14	235 1/4 EL
13	Hexagonal sockets /4-4,5-5-5,5-6-7-8-9-10-11-12-13-14	235 1/4 EN
3	Extensions/50-100-150	236 1/4
1	Flexible extension	236 1/4 SN
1	Reversible ratchet with sealed mechanism	237 B 1/4
1	T-handle with sliding square drive	240 1/4
1	Universal joint	241 1/4
1	Spinner with handle	243 1/4
4	Bits for slot-head screws -1/4" / 0,6x4,5-0,8x5,5-1x5,5-1,2x6,5	660
5	Bits for hex socket screws -1/4" / 2,5-3-4-5-6	660 E
3	Bits for PHILLIPS® screws -1/4" / 1-2-3	660 PH
1	Bit-holder sockets	684/1/4
1	Empty ABS case - size L	606 L

LxPxH mm	kg	code	
435x270x70	2,5	U06070104	1



$\frac{1}{4}$   $\frac{1}{2}$

## 607 $\frac{1}{4}$ "- $\frac{1}{2}$ " EA

### Assortment with hexagonal sockets in ABS case (56 pcs.)

- High resistance ABS case with quick closing system
- The inside tray is studied to be stored in USAG roller cabinet drawers
- Empty inner plastic tray: code U05190839Q

pcs	description	item/size
16	Hexagonal sockets /10-11-12-13-14-15-16-17-18-19-21-22-24-27-30-32	235 1/2 EN
10	Hexagonal sockets /5,5-6-7-8-9-10-11-12-13-14	235 1/4 EN
1	Extensions	236 1/2/125
2	Extensions/50-100	236 1/4
1	Reversible ratchet with sealed mechanism (certified IP51)	237 A 1/2
1	Reversible ratchet with sealed mechanism (certified IP51)	237 A 1/4
1	Universal joint	241 1/2
1	Universal joint	241 1/4
1	Spinner with handle	243 1/4
3	Bits for slot-head screws -1/4" / 0,8x5,5-1x5,5-1,2x6,5	660
5	Bits for hex socket screws -1/4" / 3-4-5-6-8	660 E
3	Bits for PHILLIPS® screws -1/4" / 1-2-3	660 PH
3	Bits for POZIDRIV® - SUPADRIV® screws -1/4" / 1-2-3	660 PZ
7	Bits for TORX® Tamper Resistant screws -1/4" / T10-T15-T20-T25-T27-T30-T40	660 STX
1	Bit-holder sockets	684/1/4
1	Empty ABS case - size L	606 L

LxPxH mm	kg	code	
435x270x70	4	U06070312	1



$\frac{1}{4}$

## 607 $\frac{1}{4}$ " EA

### Assortment with hexagonal sockets in ABS case (44 pcs.)

- High resistance ABS case with quick closing system
- The inside tray is studied to be stored in USAG roller cabinet drawers
- Empty inner plastic tray: code U05190353Q

pcs	description	item/size
10	Long hexagonal sockets / 5-6-7-8-9-10-11-12-13-14	235 1/4 EL
13	Hexagonal sockets / 4-4,5-5-5,5-6-7-8-9-10-11-12-13-14	235 1/4 EN
3	Extensions/50-100-150	236 1/4
1	Flexible extension	236 1/4 SN
1	Reversible ratchet with sealed mechanism (certified IP51)	237 A 1/4
1	T-handle with sliding square drive	240 1/4
1	Universal joint	241 1/4
1	Spinner with handle	243 1/4
4	Bits for slot-head screws -1/4" / 0,6x4,5-0,8x5,5-1x5,5-1,2x6,5	660
5	Bits for hex socket screws -1/4" / 2,5-3-4-5-6	660 E
3	Bits for PHILLIPS® screws -1/4" / 1-2-3	660 PH
1	Bit-holder sockets	684/1/4
1	Empty ABS case - size L	606 L

LxPxH mm	kg	code	
435x270x70	2,5	U06070102	1

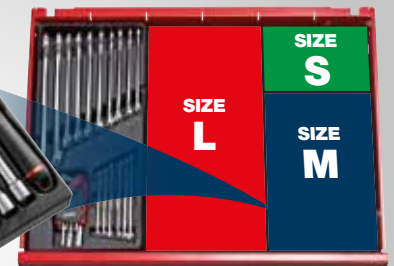

THE INSIDE TRAY IS STUDIED TO BEMODULAR AND CAN BE STORED IN USAG ROLLER CABINET DRAWERS





1/4 1/2

### 607 1/4"-1/2" EB

#### Assortment with hexagonal sockets in ABS case (56 pcs.)

- High resistance ABS case with quick closing system
- The inside tray is studied to be stored in USAG roller cabinet drawers
- Empty inner plastic tray: code U05190839Q

pcs	description	item/size
16	Hexagonal sockets / 10-11-12-13-14-15-16-17-18-19-21-22-24-27-30-32	235 1/2 EN
10	Hexagonal sockets /5,5-6-7-8-9-10-11-12-13-14	235 1/4 EN
1	Extensions	236 1/2/125
2	Extensions/50-100	236 1/4
1	Reversible ratchet with sealed mechanism	237 B 1/2
1	Reversible ratchet with sealed mechanism	237 B 1/4
1	Universal joint	241 1/2
1	Universal joint	241 1/4
1	Spinner with handle	243 1/4
3	Bits for slot-head screws -1/4" / 0,8x5,5-1x5,5-1,2x6,5	660
5	Bits for hex socket screws -1/4" / 3-4-5-6-8	660 E
3	Bits for PHILLIPS® screws -1/4" / 1-2-3	660 PH
3	Bits for POZIDRIV® - SUPADRIV® screws -1/4" / 1-2-3	660 PZ
7	Bits for TORX® Tamper Resistant screws -1/4" / T10-T15-T20-T25-T27-T30-T40	660 STX
1	Bit-holder sockets	684/1/4
1	Empty ABS case - size L	606 L

LxPxH mm	kg	code	
435x270x70	4	U06070314	1



### 607 1/2" A

#### Assortment with bihexagonal sockets in ABS case (25 pcs.)

- High resistance ABS case with quick closing system
- The inside tray is studied to be stored in USAG roller cabinet drawers
- Empty inner plastic tray: code U06070300Q

pcs	description	item/size
19	Bihexagonal sockets /8-9-10-11-12-13-14-15-16-17-18-19-21-22-23-24-27-30-32	235 1/2 N
2	Extensions/125-250	236 1/2
1	Reversible ratchet with sealed mechanism (certified IP51)	237 A 1/2
1	Speed brace with revolving handle	239 1/2 N
1	T-handle with sliding square drive	240 1/2 N
1	Universal joint	241 1/2
1	Empty ABS case - size L	606 L

LxPxH mm	kg	code	
435x270x70	4,5	U06070301	1



### 607 1/2" EA

#### Assortment with hexagonal sockets in ABS case (25 pcs.)

- High resistance ABS case with quick closing system
- The inside tray is studied to be stored in USAG roller cabinet drawers
- Empty inner plastic tray: code U06070300Q

pcs	description	item/size
19	Hexagonal sockets /8-9-10-11-12-13-14-15-16-17-18-19-21-22-23-24-27-30-32	235 1/2 EN
2	Extensions/125-250	236 1/2
1	Reversible ratchet with sealed mechanism (certified IP51)	237 A 1/2
1	Speed brace with revolving handle	239 1/2 N
1	T-handle with sliding square drive	240 1/2 N
1	Universal joint	241 1/2
1	Empty ABS case - size L	606 L

LxPxH mm	kg	code	
435x270x70	4,5	U06070302	1



### 607 1/2" B

#### Assortment with bihexagonal sockets in ABS case (30 pcs.)

- High resistance ABS case with quick closing system
- The inside tray is studied to be stored in USAG roller cabinet drawers
- Empty inner plastic tray: code U06070300Q

pcs	description	item/size
24	Bihexagonal sockets /8-9-10-11-12-13-14-15-16-17-18-19-20-21-22-23-24-26-27-28-29-30-32-34	235 1/2 N
2	Extensions/125-250	236 1/2
1	Reversible ratchet with sealed mechanism	237 B 1/2
1	Speed brace with revolving handle	239 1/2 N
1	T-handle with sliding square drive	240 1/2 N
1	Universal joint	241 1/2
1	Empty ABS case - size L	606 L

LxPxH mm	kg	code	
435x270x70	4,5	U06070303	1



### 607 1/2" EB

#### Assortment with hexagonal sockets in ABS case (30 pcs.)

- High resistance ABS case with quick closing system
- The inside tray is studied to be stored in USAG roller cabinet drawers
- Empty inner plastic tray: code U06070300Q

pcs	description	item/size
24	Hexagonal sockets /8-9-10-11-12-13-14-15-16-17-18-19-20-21-22-23-24-26-27-28-29-30-32-34	235 1/2 EN
2	Extensions/125-250	236 1/2
1	Reversible ratchet with sealed mechanism	237 B 1/2
1	Speed brace with revolving handle	239 1/2 N
1	T-handle with sliding square drive	240 1/2 N
1	Universal joint	241 1/2
1	Empty ABS case - size L	606 L

LxPxH mm	kg	code	
435x270x70	4,5	U06070304	1



1/2

### 607 1 1/2" EA

#### Assortment with hexagonal sockets in ABS case (48 pcs.)

- High resistance ABS case with quick closing system
- The inside tray is studied to be stored in USAG roller cabinet drawers
- Empty inner plastic tray: code U05190841Q

pcs	description	item/size
18	Hexagonal sockets / 8-10-11-12-13-14-15-16-17-18-19-21-22-23-24-27-30-32	235 1/2 EN
2	Extensions/125-250	236 1/2
1	Reversible ratchet with sealed mechanism (certified IP51)	237 A 1/2
1	Universal joint	241 1/2
4	Bits for slot-head screws - 5/16" / 0,8x5,5-1x6,5-1,2x8-1,6x10	661
4	Bits for hex socket screws - 5/16" / 5-6-8-10	661 E
3	Bits for PHILLIPS® screws - 5/16" / 1-2-3	661 PH
3	Bits for POZIDRIV®-SUPADRIV® screws - 5/16" / 1-2-3	661 PZ
6	Bits for TORX® screws - 5/16" / T27-T30-T40-T45-T50-T55	661 TX
5	Bits for hex socket screws - 1/4" / 5-6-7-8-10	664 EL
1	Bit-holder sockets	684/1/2
1	Empty ABS case - size L	606 L

LxPxH mm	kg	code	
435x270x70	4,5	U06070306	1



1/2

### 607 1 1/2" EB

#### Assortment with hexagonal sockets in ABS case (48 pcs.)

- High resistance ABS case with quick closing system
- The inside tray is studied to be stored in USAG roller cabinet drawers
- Empty inner plastic tray: code U05190841Q

pcs	description	item/size
18	Hexagonal sockets / 8-10-11-12-13-14-15-16-17-18-19-21-22-23-24-27-30-32	235 1/2 EN
2	Extensions/125-250	236 1/2
1	Reversible ratchet with sealed mechanism	237 B 1/2
1	Universal joint	241 1/2
4	Bits for slot-head screws - 5/16" / 0,8x5,5-1x6,5-1,2x8-1,6x10	661
4	Bits for hex socket screws - 5/16" / 5-6-8-10	661 E
3	Bits for PHILLIPS® screws - 5/16" / 1-2-3	661 PH
3	Bits for POZIDRIV®-SUPADRIV® screws - 5/16" / 1-2-3	661 PZ
6	Bits for TORX® screws - 5/16" / T27-T30-T40-T45-T50-T55	661 TX
5	Bits for hex socket screws - 1/4" / 5-6-7-8-10	664 EL
1	Bit-holder sockets	684/1/2
1	Empty ABS case - size L	606 L

LxPxH mm	kg	code	
435x270x70	4,5	U06070308	1



1/4

### 608 1/4" EA

#### Assortment with hexagonal sockets in ABS case (37 pcs.)

- High resistance ABS case with quick closing system
- The inside tray is studied to be stored in USAG roller cabinet drawers
- Empty inner foam module: code U05190966Q

pcs	description	item/size
10	Hexagonal sockets / 5,5-6-7-8-9-10-11-12-13-14	235 1/4 EN
2	Extensions/50-100	236 1/4
1	Reversible ratchet with sealed mechanism (certified IP51)	237 A 1/4
1	Universal joint	241 1/4
1	Spinner with handle	243 1/4
3	Bits for slot-head screws - 1/4" / 0,6x4,5-0,8x5,5-1x5,5	660
5	Bits for hex socket screws - 1/4" / 2,5-3-4-5-6	660 E
3	Bits for PHILLIPS® screws - 1/4" / 1-2-3	660 PH
3	Bits for POZIDRIV® - SUPADRIV® screws - 1/4" / 1-2-3	660 PZ
7	Bits for TORX® Tamper Resistant screws - 1/4" / T10-T15-T20-T25-T27-T30-T40	660 STX
1	Bit-holder sockets	684/1/4
1	Empty ABS case - size S	606 S

LxPxH mm	kg	code	
210x130x60	800	U06080101	1



## 237 A

Reversible ratchet



YouTube



**Certified IP51**  
Head mechanism protected from dust and water.



**Patented internal mechanism**  
Lasts longer than any other ratchet.



**Head thickness reduced**  
Better accessibility.





1/4

**608 1/4" EB**

**Assortment with hexagonal sockets in ABS case (37 pcs.)**

- High resistance ABS case with quick closing system
- The inside tray is studied to be stored in USAG roller cabinet drawers
- Empty inner foam module: code U05190966Q

pcs	description	item/size
10	Hexagonal sockets /5,5-6-7-8-9-10-11-12-13-14	235 1/4 EN
2	Extensions/50-100	236 1/4
1	Reversible ratchet with sealed mechanism	237 B 1/4
1	Universal joint	241 1/4
1	Spinner with handle	243 1/4
3	Bits for slot-head screws -1/4" / 0,6x4,5-0,8x5,5-1x5,5	660
5	Bits for hex socket screws -1/4" / 2,5-3-4-5-6	660 E
3	Bits for PHILLIPS® screws -1/4" / 1-2-3	660 PH
3	Bits for POZIDRIV® - SUPADRIV® screws -1/4" / 1-2-3	660 PZ
7	Bits for TORX® Tamper Resistant screws -1/4" / T10-T15-T20-T25-T27-T30-T40	660 STX
1	Bit-holder sockets	684/1/4
1	Empty ABS case - size S	606 S

LxPxH mm	kg	code	
210x130x60	800	U06080102	1



**608 1/4" EAK**

**Assortment with hexagonal sockets in ABS case (50 pcs.)**

- High resistance ABS case with quick closing system
- The inside tray is studied to be stored in USAG roller cabinet drawers
- Empty inner foam module: code U05191020Q

pcs	description	item/size
13	Hexagonal sockets / 4-4,5-5-5,5-6-7-8-9-10-11-12-13-14	235 1/4 EN
1	Reversible ratchet with revolving handle	237 1/4 AK
1	Spinner with handle	243 1/4
1	Flexible spinner with handle	243 1/4 SN
1	T-handle key with jointed square drive	273 1/4 Q
31	Assortment with bits and reversible ratchet (31 pcs.)	606 1/4 SK
1	Bit-holder sockets	684/1
1	Empty ABS case - size L	606 L

LxPxH mm	code	
435x270x70	U06080305	1



**608 3/8" EA**

**Assortment with hexagonal sockets in ABS case (20 pcs.)**

- High resistance ABS case with quick closing system
- The inside tray is studied to be stored in USAG roller cabinet drawers
- Empty inner foam module: code U05190928Q

pcs	description	item/size
15	Hexagonal sockets /7-8-9-10-11-12-13-14-15-16-17-18-19-21-22	235 3/8 E
2	Extensions/125-250	236 3/8
1	Reversible ratchet with sealed mechanism (certified IP51)	237 A 3/8
1	T-handle with sliding square drive	240 3/8 N
1	Universal joint	241 3/8
1	Empty ABS case - size L	606 L

LxPxH mm	kg	code	
435x270x70	1,5	U06080202	1



**608 3/8" EB**

**Assortment with hexagonal sockets in ABS case (20 pcs.)**

- High resistance ABS case with quick closing system
- The inside tray is studied to be stored in USAG roller cabinet drawers
- Empty inner foam module: code U05190928Q

pcs	description	item/size
15	Hexagonal sockets /7-8-9-10-11-12-13-14-15-16-17-18-19-21-22	235 3/8 E
2	Extensions/125-250	236 3/8
1	Reversible ratchet with sealed mechanism	237 B 3/8
1	T-handle with sliding square drive	240 3/8 N
1	Universal joint	241 3/8
1	Empty ABS case - size L	606 L

LxPxH mm	kg	code	
435x270x70	1,5	U06080204	1



**608 1/2" EA**

**Assortment with hexagonal sockets in ABS case (23 pcs.)**

- High resistance ABS case with quick closing system
- The inside tray is studied to be stored in USAG roller cabinet drawers
- Empty inner foam module: code U05190942Q

pcs	description	item/size
18	Hexagonal sockets / 8-10-11-12-13-14-15-16-17-18-19-21-22-23-24-27-30-32	235 1/2 EN
2	Extensions/125-250	236 1/2
1	Reversible ratchet with sealed mechanism (certified IP51)	237 A 1/2
1	T-handle with sliding square drive	240 1/2 N
1	Universal joint	241 1/2
1	Empty ABS case - size L	606 L

LxPxH mm	kg	code	
435x270x70	3	U06080302	1

**608 1/4" EAK**  
THE TOP FOR HARD TO REACH AREAS



T-handle key with jointed square drive



Flexible spinner with handle



Reversible ratchet with revolving handle



Hinged ratchet for bits



1/2

### 608 1/2" EB

#### Assortment with hexagonal sockets in ABS case (23 pcs.)

- High resistance ABS case with quick closing system
- The inside tray is studied to be stored in USAG roller cabinet drawers
- Empty inner foam module: code U05190942Q



pcs	description	item/size
18	Hexagonal sockets / 8-10-11-12-13-14-15-16-17-18-19-21-22-23-24-27-30-32	235 1/2 EN
2	Extensions/125-250	236 1/2
1	Reversible ratchet with sealed mechanism	237 B 1/2
1	T-handle with sliding square drive	240 1/2 N
1	Universal joint	241 1/2
1	Empty ABS case - size L	606 L

LxPxH mm	kg	code	img
435x270x70	3	U06080304	1



1/4

### 609 1/4" EB

#### Assortment with hexagonal sockets and bits in bimaterial box (38 pcs.)

- Compact bimaterial box with soft-touch covering
- Metal closing clip
- Socket size engraved inside
- Compact dimensions: 30% less bulky than the standard boxes



pcs	description	item/size
10	Hexagonal sockets / 5,5-6-7-8-9-10-11-12-13-14	235 1/4 EN
2	Extensions/50-100	236 1/4
1	Reversible ratchet with sealed mechanism	237 B 1/4
1	Universal joint	241 1/4
1	Spinner with handle	243 1/4
3	Bits for slot-head screws -1/4" / 0,6x4,5-1x5,5-1,2x6,5	660
5	Bits for hex socket screws -1/4" / 2-3-4-5-6	660 E
3	Bits for PHILLIPS® screws -1/4" / 1-2-3	660 PH
3	Bits for POZIDRIV® - SUPADRIV® screws -1/4" / 1-2-3	660 PZ
1	Socket-holder bit -1/4"	660 Q
7	Bits for TORX® Tamper Resistant screws -1/4" / T10-T15-T20-T25-T27-T30-T40	660 STX
1	Bit-holder sockets	684/1/4
1	Empty bimaterial box	609 1/4 V1

LxPxH mm	gr	code	img
155x95x50	900	U06090002	1



### 609 1/4" EBP

#### Assortment with hexagonal sockets and bits in bimaterial box (38 pcs)

- Compact bimaterial box with soft-touch covering
- Metal closing clip
- Socket size engraved inside
- Compact dimensions: 30% less bulky than the standard boxes

pcs	description	item/size
10	Hexagonal sockets / 5,5-6-7-8-9-10-11-12-13-14	235 1/4 EN
2	Extensions/50-100	236 1/4
1	Reversible ratchet with socket retaining system	237 1/4 BP
1	Universal joint	241 1/4
1	Spinner with handle	243 1/4
3	Bits for slot-head screws -1/4" / 0,6x4,5-1x5,5-1,2x6,5	660
5	Bits for hex socket screws -1/4" / 2-3-4-5-6	660 E
3	Bits for PHILLIPS® screws -1/4" / 1-2-3	660 PH
3	Bits for POZIDRIV® - SUPADRIV® screws -1/4" / 1-2-3	660 PZ
1	Socket-holder bit -1/4"	660 Q
7	Bits for TORX® Tamper Resistant screws -1/4" / T10-T15-T20-T25-T27-T30-T40	660 STX
1	Bit-holder sockets	684/1/4
1	Empty bimaterial box	609 1/4 V1

LxPxH mm	gr	code	img
155x95x50	900	U06090030	1



### 609 1/4" V1

#### Empty bimaterial box

- For assortments 609 1/4 EB, 609 1/4 EBP

LxPxH mm	code	img
155x95x50	U06090001Q	1



3/8

### 609 3/8" B

#### Assortment with bihexagonal sockets in bimaterial box (18 pcs.)

- Bimaterial box with soft-touch covering
- Content always under control
- Metal closing clip
- Socket size engraved inside
- Steel handle: the extension contained in the set is also the box handle

pcs	description	item/size
14	Bihexagonal sockets / 8-9-10-11-12-13-14-15-16-17-18-19-21-22	235 3/8
2	Extensions/125-250	236 3/8
1	Reversible ratchet with sealed mechanism	237 B 3/8
1	Universal joint	241 3/8
1	Empty bimaterial box	609 3/8 V1

LxPxH mm	kg	code	img
280x150x50	2	U06090016	1



3/8

### 609 3/8" EB

#### Assortment with hexagonal sockets in bimaterial box (18 pcs.)

- Bimaterial box with soft-touch covering
- Content always under control
- Metal closing clip
- Socket size engraved inside
- Steel handle: the extension contained in the set is also the box handle.



pcs	description	item/size
14	Hexagonal sockets / 8-9-10-11-12-13-14-15-16-17-18-19-21-22	235 3/8 E
2	Extensions/125-250	236 3/8
1	Reversible ratchet with sealed mechanism	237 B 3/8
1	Universal joint	241 3/8
1	Empty bimaterial box	609 3/8 V1

LxPxH mm	kg	code	img
280x150x50	2	U06090012	1



### 609 3/8" V1

#### Empty bimaterial box

- For assortments 609 3/8 B, 609 3/8 EB

LxPxH mm	code	
280x150x50	U06090002QR	1



1/2



### 609 1/2" EB

#### Assortment with hexagonal sockets in bimaterial box (21 pcs.)

- Bimaterial box with soft-touch covering
- Content always under control
- Metal closing clip
- Socket size engraved inside
- Steel handle: the extension contained in the set is also the box handle
- Modularity: the box has the same dimensions as a toolholding tray and can be stored in H 60 mm drawers



pcs description	item/size
17 Hexagonal sockets / 8-10-11-12-13-14-15-16-17-18-19-21-22-24-27-30-32	235 1/2 EN
2 Extensions/125-250	236 1/2
1 Reversible ratchet with sealed mechanism	237 B 1/2
1 Universal joint	241 1/2
1 Empty bimaterial box	609 1/2 V1

LxPxH mm	kg	code	
335x180x55	3,7	U06090022	1



### 609 1/2" V1

#### Empty bimaterial box

- For assortments 609 1/2 B, 609 1/2 EB, 609 1/2 EBP

LxPxH mm	code	
335x180x55	U06090003Q	1



1/4

### 610 1/4" EFK

#### Assortment with short hexagonal sockets and reversible ratchet in bimaterial box (11 pcs.)

- Compact bimaterial box with soft-touch covering
- Socket size engraved inside
- Metal closing clip
- Reversible ratchet with articulated head 237 FK 1/4"
- Sockets: 5,5-6-7-8-9-10-11-12-13-14 mm
- Short sockets: 50% less bulky than the standard ones

pcs description	item/size
10 Short hexagonal sockets / 5,5-6-7-8-9-10-11-12-13-14	235 1/4 ERN
1 Reversible ratchet for short sockets	237 1/4 FK

LxPxH mm	gr	code	
120x60x30	265	U06100001	1



1/2



### 609 1/2" B

#### Assortment with bihexagonal sockets in bimaterial box (21 pcs.)

- Bimaterial box with soft-touch covering
- Content always under control
- Metal closing clip
- Socket size engraved inside
- Steel handle: the extension contained in the set is also the box handle
- Modularity: the box has the same dimensions as a toolholding tray and can be stored in H 60 mm drawers



pcs description	item/size
17 Bihexagonal sockets / 8-10-11-12-13-14-15-16-17-18-19-21-22-24-27-30-32	235 1/2 N
2 Extensions/125-250	236 1/2
1 Reversible ratchet with sealed mechanism	237 B 1/2
1 Universal joint	241 1/2
1 Empty bimaterial box	609 1/2 V1

LxPxH mm	kg	code	
335x180x55	3,7	U06090026	1



1/2



### 609 1/2" EBP

#### Assortment with hexagonal sockets in bimaterial box (21 pcs)

- Bimaterial box with soft-touch covering
- Content always under control
- Metal closing clip
- Socket size engraved inside
- Steel handle: the extension contained in the set is also the box handle
- Modularity: the box has the same dimensions of a toolholding tray and can be stored in h 60 mm drawers



pcs description	item/size
17 Hexagonal sockets / 8-10-11-12-13-14-15-16-17-18-19-21-22-24-27-30-32	235 1/2 EN
2 Extensions/125-250	236 1/2
1 Reversible ratchet with socket retaining system	237 1/2 BP
1 Universal joint	241 1/2
1 Empty bimaterial box	609 1/2 V1

LxPxH mm	kg	code	
335x180x55	3,7	U06090032	1



1/4

### 612 1/4" EA

#### Assortment in sheet steel box with hexagonal sockets (19 pcs.)

- Metal closing clip
- The inside tray is studied to be stored in USAG roller cabinet drawers
- Empty inner plastic tray: code U06060100Q
- Empty sheet steel box: code U06120001Q



pcs description	item/size
13 Hexagonal sockets / 4-4,5-5-5,5-6-7-8-9-10-11-12-13-14	235 1/4 EN
2 Extensions/50-100	236 1/4
1 Reversible ratchet with sealed mechanism (certified IP51)	237 A 1/4
1 T-handle with sliding square drive	240 1/4
1 Universal joint	241 1/4
1 Spinner with handle	243 1/4
1 Plastic tray (empty)	519/606AV
1 Sheet steel box (empty) - size S	612 S

LxPxH mm	kg	code	
203x120x48	1,5	U06120006	1



1/4

### 612 1/4" EB

#### Assortment in sheet steel box with hexagonal sockets (19 pcs.)

- Metal closing clip
- The inside tray is studied to be stored in USAG roller cabinet drawers
- Empty inner plastic tray: code U06060100Q
- Empty sheet steel box: code U06120001Q

pcs	description	item/size
13	Hexagonal sockets /4-4,5-5-5,5-6-7-8-9-10-11-12-13-14	235 1/4 EN
2	Extensions/50-100	236 1/4
1	Reversible ratchet with sealed mechanism	237 B 1/4
1	T-handle with sliding square drive	240 1/4
1	Universal joint	241 1/4
1	Spinner with handle	243 1/4
1	Plastic tray (empty)	519/606AV
1	Sheet steel box (empty) - size S	612 S

LxPxH mm	kg	code	
203x120x48	1,5	U06120007	1



3/8

### 612 3/8" EB

#### Assortment in sheet steel box with hexagonal sockets (18 pcs.)

- Closing clip and carrying handle
- The inside tray is studied to be stored in USAG roller cabinet drawers
- Empty inner plastic tray: U05190711Q
- Empty sheet steel box: code U06120002Q

pcs	description	item/size
14	Hexagonal sockets /8-9-10-11-12-13-14-15-16-17-18-19-21-22	235 3/8 E
2	Extensions/125-250	236 3/8
1	Reversible ratchet with sealed mechanism	237 B 3/8
1	Universal joint	241 3/8
1	Plastic tray (empty)	519/604BAV
1	Sheet steel box (empty) - size M	612 M

LxPxH mm	kg	code	
320x205x207	2,8	U06120009	1



1/2

### 612 1/2" EA

#### Assortment in sheet steel box with hexagonal sockets (23 pcs.)

- Closing clip and carrying handle
- The inside tray is studied to be stored in USAG roller cabinet drawers
- Empty inner plastic tray: code U06060300Q
- Empty sheet steel box: code U06120004Q

pcs	description	item/size
19	Hexagonal sockets /8-9-10-11-12-13-14-15-16-17-18-19-21-22-23-24-27-30-32	235 1/2 EN
2	Extensions/125-250	236 1/2
1	Reversible ratchet with sealed mechanism (certified IP51)	237 A 1/2
1	Universal joint	241 1/2
1	Plastic tray (empty)	519/606CAV
1	Sheet steel box (empty) - size M	612 M

LxPxH mm	kg	code	
320x205x57	4,5	U06120010	1



3/8

### 612 3/8" EA

#### Assortment in sheet steel box with hexagonal sockets (18 pcs.)

- Closing clip and carrying handle
- The inside tray is studied to be stored in USAG roller cabinet drawers
- Empty inner plastic tray: code U05190711Q
- Empty sheet steel box: code U06120002Q

pcs	description	item/size
14	Hexagonal sockets /8-9-10-11-12-13-14-15-16-17-18-19-21-22	235 3/8 E
2	Extensions/125-250	236 3/8
1	Reversible ratchet with sealed mechanism (certified IP51)	237 A 3/8
1	Universal joint	241 3/8
1	Plastic tray (empty)	519/604BAV
1	Sheet steel box (empty) - size M	612 M

LxPxH mm	kg	code	
320x205x57	2,8	U06120008	1



3/8

### 612 3/8" S13

#### Assortment with crowfoot wrenches in sheet steel case (13 pcs)

- Closing clip and carrying handle
- The inside tray is studied to be stored in USAG roller cabinet drawers
- Empty bi-colour foam module: code U05190985Q
- Empty sheet steel box: code U06120002Q

pcs	description	item/size
2	Extensions/125-250	236 3/8
1	T-handle with sliding square drive	240 3/8 N
1	Universal joint	241 3/8
9	Crow-foot wrenches / 10-11-12-13-14-17-19-22-24	257 3/8
1	Bi-colour foam module (empty)	519 M 612S13V
1	Sheet steel box (empty) - size M	612 M

LxPxH mm	kg	code	
188x311x45	2,6	U06120100	1



1/2

### 612 1/2" EB

#### Assortment in sheet steel box with hexagonal sockets (23 pcs.)

- Closing clip and carrying handle
- The inside tray is studied to be stored in USAG roller cabinet drawers
- Empty inner plastic tray: code U06060300Q
- Empty sheet steel box: code U06120004Q

pcs	description	item/size
19	Hexagonal sockets / 8-9-10-11-12-13-14-15-16-17-18-19-21-22-23-24-27-30-32	235 1/2 EN
2	Extensions/125-250	236 1/2
1	Reversible ratchet with sealed mechanism	237 B 1/2
1	Universal joint	241 1/2
1	Plastic tray (empty)	519/606CAV
1	Sheet steel box (empty) - size M	612 M

LxPxH mm	kg	code	
320x205x57	4,5	U06120011	1



1/2

### 612 1/2" CEB

#### Assortment in sheet steel box with hexagonal sockets (22 pcs.)

- Closing clip and carrying handle
- The inside tray is studied to be stored in USAG roller cabinet drawers
- Empty bi-colour foam module: code U05190347Q
- Empty sheet steel box: code U06120003Q

pcs	description	item/size
17	Bihexagonal sockets / 10-11-12-13-14-15-16-17-18-19-20-21-22-24-27-30-32	235 1/2 N
2	Extensions/125-250	236 1/2
1	Reversible ratchet with sealed mechanism	237 B 1/2
1	T-handle with sliding square drive	240 1/2 N
1	Universal joint	241 1/2
1	Plastic tray (empty)	519/613CEBV

LxPxH mm	kg	code	
320x205x57	4,5	U06120030	1



1/2

### 612 1/2" CLB

#### Assortment in sheet steel box with hexagonal and bihexagonal sockets (35 pcs.)

- Closing clip and carrying handle
- The inside tray is studied to be stored in USAG roller cabinet drawers
- Empty bi-colour foam module: code U05190988Q
- Empty sheet steel box: code U06120004Q

pcs	description	item/size
10	Long bihexagonal sockets / 10-12-13-14-17-19-22-24-27-30	235 1/2 LN
20	Bihexagonal sockets /8-9-10-11-12-13-14-15-16-17-18-19-20-21-22-23-24-27-30-32	235 1/2 N
2	Extensions/125-250	236 1/2
1	Reversible ratchet with sealed mechanism	237 B 1/2
1	T-handle with sliding square drive	240 1/2 N
1	Universal joint	241 1/2
1	Bi-colour foam module (empty)	519 M 612CLAV
1	Sheet steel box (empty) - size XL	612 XL

LxPxH mm	kg	code	
425x395x83	9	U06122013	1



1/2

### 612 1/2" MPB

#### Assortment in sheet steel box with bihexagonal sockets (35 pcs.)

- Closing clip and carrying handle
- The inside tray is studied to be stored in USAG roller cabinet drawers
- Empty bi-colour foam module: code U05190986Q
- Empty sheet steel box: code U06120004Q

pcs	description	item/size
15	Bihexagonal sockets / 10-11-12-13-14-15-16-17-18-19-22-24-27-30-32	235 1/2 N
15	Bihexagonal sockets, inch sizes / 3/8-7/16-1/2-9/16-5/8-11/16-3/4-13/16-7/8-15/16-1-1 1/16-1 1/8-1 3/16-1 1/4	235 1/2 PN
2	Extensions/125-250	236 1/2
1	Reversible ratchet with sealed mechanism	237 B 1/2
1	T-handle with sliding square drive	240 1/2 N
1	Universal joint	241 1/2
1	Bi-colour foam module (empty)	519 M 612CMPAV
1	Sheet steel box (empty) - size XL	612 XL

LxPxH mm	kg	code	
425x395x83	7,5	U06122015	1



1/2

### 612 1/2" CLA

#### Assortment in sheet steel box with hexagonal and bihexagonal sockets (35 pcs.)

- Closing clip and carrying handle
- The inside tray is studied to be stored in USAG roller cabinet drawers
- Empty bi-colour foam module: code U05190988Q
- Empty sheet steel box: code U06120004Q

pcs	description	item/size
10	Long bihexagonal sockets / 10-12-13-14-17-19-22-24-27-30	235 1/2 LN
20	Bihexagonal sockets / 8-9-10-11-12-13-14-15-16-17-18-19-20-21-22-23-24-27-30-32	235 1/2 N
2	Extensions/125-250	236 1/2
1	Reversible ratchet with sealed mechanism (certified IP51)	237 A 1/2
1	T-handle with sliding square drive	240 1/2 N
1	Universal joint	241 1/2
1	Bi-colour foam module (empty)	519 M 612CLAV
1	Sheet steel box (empty) - size XL	612 XL

LxPxH mm	kg	code	
425x395x83	9	U06122012	1



1/2

### 612 1/2" MPA

#### Assortment in sheet steel box with bihexagonal sockets (35 pcs.)

- Closing clip and carrying handle
- The inside tray is studied to be stored in USAG roller cabinet drawers
- Empty bi-colour foam module: code U05190986Q
- Empty sheet steel box: code U06120004Q

pcs	description	item/size
15	Bihexagonal sockets / 10-11-12-13-14-15-16-17-18-19-22-24-27-30-32	235 1/2 N
15	Bihexagonal sockets, inch sizes / 3/8-7/16-1/2-9/16-5/8-11/16-3/4-13/16-7/8-15/16-1-1 1/16-1 1/8-1 3/16-1 1/4	235 1/2 PN
2	Extensions/125-250	236 1/2
1	Reversible ratchet with sealed mechanism (certified IP51)	237 A 1/2
1	T-handle with sliding square drive	240 1/2 N
1	Universal joint	241 1/2
1	Bi-colour foam module (empty)	519 M 612CMPAV
1	Sheet steel box (empty) - size XL	612 XL

LxPxH mm	kg	code	
425x395x83	7,5	U06122014	1



3/4

### 612 3/4" B

#### Assortment in sheet steel box with bihexagonal sockets (17 pcs.)

- Closing clip and carrying handle
- The inside tray is studied to be stored in USAG roller cabinet drawers
- Empty bi-colour foam module: code U05190990Q
- Empty sheet steel box: code U06120004Q

pcs	description	item/size
13	Bihexagonal sockets /22-23-24-26-27-28-30-32-36-38-41-46-50	235 3/4 N
2	Extensions/200-400	236 3/4
1	Reversible ratchet with sealed mechanism	237 B 3/4
1	T-handle with sliding square drive	240 3/4 N
1	Bi-colour foam module (empty)	519 M 612EBV
1	Sheet steel box (empty) - size XL	612 XL

LxPxH mm	kg	code	
425x395x83	13	U06120016	1



3/4

### 612 3/4" EB

#### Assortment in sheet steel box with hexagonal sockets (17 pcs.)

- Closing clip and carrying handle
- The inside tray is studied to be stored in USAG roller cabinet drawers
- Empty bi-colour foam module: code U05190990Q
- Empty sheet steel box: code U06120004Q

pcs	description	item/size
13	Hexagonal sockets /22-23-24-26-27-28-30-32-36-38-41-46-50	235 3/4 EN
2	Extensions/200-400	236 3/4
1	Reversible ratchet with sealed mechanism	237 B 3/4
1	T-handle with sliding square drive	240 3/4 N
1	Bi-colour foam module (empty)	519 M 612EBV
1	Sheet steel box (empty) - size XL	612 XL

LxPxH mm	Kg	code	
425x395x83	13	U06120017	1



1

### 612 1" ESI

#### Assortment in sheet steel box with hexagonal sockets (12 pcs.)

- Closing clip and carrying handle
- The inside tray is studied to be stored in USAG roller cabinet drawers
- Empty bi-colour foam module: code U05190993Q
- Empty sheet steel box: code U06120005Q

pcs	description	item/size
8	Hexagonal sockets /46-50-55-60-65-70-75-80	235 1 EN
2	Extensions	236 1/200-415
1	Reversible ratchet	237 1 SI
1	T-handle with sliding square drive	240 1 N
1	Bi-colour foam module (empty)	519 M 612ESIV
1	Sheet steel box (empty) - size XXL	612 XXL

LxPxH mm	Kg	code	
575x435x127	26	U06120019	1



### 612 S

#### Sheet steel box (empty) - size S

- Closing clip

LxPxH mm	kg	code	
203x120x48	800	U06120001Q	1



### 612 M

#### Sheet steel box (empty) - size M

- Closing clip and carrying handle

LxPxH mm	Kg	code	
320x205x57	1,4	U06120002Q	1



### 612 L

#### Sheet steel box (empty) - size L

- Closing clip and carrying handle

LxPxH mm	Kg	code	
430x205x60	2,1	U06120003Q	1



### 612 XL

#### Sheet steel box (empty) - size XL

- Closing clip and carrying handle

LxPxH mm	Kg	code	
425x395x83	3,3	U06120004Q	1



3/4

### 612 3/4" PB

#### Assortment in sheet steel box with bihexagonal sockets, inch sizes (17 pcs.)

- Closing clip and carrying handle
- The inside tray is studied to be stored in USAG roller cabinet drawers
- Empty bi-colour foam module: code U05190990Q
- Empty sheet steel box: code U06120004Q

pcs	description	item/size
13	Bihexagonal sockets, inch sizes / 7/8-15/16-1-1 1/16-1 1/8-1 1/4-1 5/16-1 7/16-1 1/2-1 5/8-1 13/16-1 7/8-2	235 3/4 PN
2	Extensions/200-400	236 3/4
1	Reversible ratchet with sealed mechanism	237 B 3/4
1	T-handle with sliding square drive	240 3/4 N
1	Bi-colour foam module (empty)	519 M 612EBV
1	Sheet steel box (empty) - size XL	612 XL

LxPxH mm	Kg	code	
425x395x83	13	U06120018	1



1

### 612 1" EPSI

#### Assortment in sheet steel box with hexagonal sockets, inch sizes (12 pcs.)

- Closing clip and carrying handle
- The inside tray is studied to be stored in USAG roller cabinet drawers
- Empty bi-colour foam module: code U05190993Q
- Empty sheet steel box: code U06120005Q

pcs	description	item/size
8	Hexagonal sockets, inch sizes / 1 13/16-2-2 3/16-2 3/8-2 5/8-2 3/4-3-3 1/8	235 1 EPN
2	Extensions	236 1/200-415
1	Reversible ratchet	237 1 SI
1	T-handle with sliding square drive	240 1 N
1	Bi-colour foam module (empty)	519 M 612ESIV
1	Sheet steel box (empty) - size XXL	612 XXL

LxPxH mm	Kg	code	
575x435x127	26	U06120020	1



## 612 XXL

### Sheet steel box (empty) - size XXL

- Closing clip and two carrying handles

LxPxH mm	kg	code	
575x435x127	5,1	U06120005Q	1



## 618

### Ratchet tap wrenches

- Short model with two jaws, ratchet for clockwise, counter-clockwise, or fixed position operation

n°	mm	L mm	code	
1	2,6÷5,5	85	U06180001	5
2	4,6÷8	110	U06180002	5



## 618 A

### Spare jaws

- For 618 and 618 L

n°	gr	code	
1	5	U06180011	1
2	11	U06180012	1



## 618 L

### Ratchet tap wrenches

- Long model with two jaws, ratchet for clockwise, counter-clockwise, or fixed position operation

n°	mm	L mm	code	
1	2,6÷5,5	255	U06180101	1
2	4,6÷8	315	U06180102	1



## 618 M

DIN 1814

### Manual tap wrenches

- Manual model with removable sliding bar and anti-slip end  
- Aluminium body with steel jaws

n°	capacity mm	L mm	code	
1	M1÷M10	175	U06180041	1
2	M3.5÷M12	277	U06180042	1
3	M5÷M20	375	U06180043	1



## 618 MF1

### Assortment with taps and tap wrenches in sheet steel case (40 pcs.)

- Taps:
- Sizes: M3-M4-M5-M6-M7-M8-M9-M10-M12 (27 pcs)
- Tap wrenches: references 618 M1 and 618 M2
- Assortment with 3 taps, coarse pitch, metric thread for hard metal
- High-speed steel HSS
- Finish-ground thread
- Right-handed coarse pitch ISO metric thread
- Machining tolerances: 6H
- Tap wrenches:
- Sizes: M3-M4-M5-M6-M7-M8-M9-M10-M12 (9 pcs)
- Die stocks: skus 832.1P and 832.1P1/2
- Chrome Vanadium high-speed steel HSS with heat treatment 62/64 HRc (234 daN/mm<sup>2</sup>)
- Right-handed coarse pitch ISO metric thread
- Tapered screw that allows an easily adjustment based on threading diameters
- Empty bi-colour foam module: U05191055Q
- Empty sheet steel box: U06120004Q

LxPxH mm	kg	code	
425x395x83	4,7	U06180050	1



## 618 MF2

### Assortment with taps in sheet steel case (29 pcs.)

- Taps sizes: M3-M4-M5-M6-M7-M8-M9-M10-M12 (27 pz)
- Tap wrenches: references 618 M1 and 618 M2
- Assortment with 3 taps, coarse pitch, metric thread for hard metal
- High-speed steel HSS
- Finish-ground thread
- Right-handed coarse pitch ISO metric thread
- Machining tolerances: 6H
- Empty bi-colour foam module: U05191056Q
- Empty sheet steel box: U06120003Q

LxPxH mm	kg	code	
430x205x57	2,6	U06180051	1



## 618 P

### Die stocks

- Alloy die casting body
- Locking screws for a perfect centring of the die
- Grey hammered finish



n°	capacity mm	L mm	code	
1	M3÷M9	220	U06180045	1
2	M10÷M12	325	U06180046	1



## 622 K/S1

### Thread repair assortment

- To restore damaged threads -M5x0.8 - M6x1 - M8x1.25 - M10x1.5 - M12x1.75
- It contains HSS-G drills 13/64 - 6,3 - 21/64 - 10,3 - 31/64
- Composed of Inserts/Taps/Tools for insert installation/ Tang break-off tools (up to Ø 8 mm)
- Supplied in plastic case

M	LxPxH mm	code	
M5÷M12	360x210x50	U06220000	1



## 622 A

### Spare threads

- Box with 10 pcs. of the same size

M	code	
5x0,8	U06220005Q	1
6x1,00	U06220006Q	1
8x1,25	U06220008Q	1
10x1,50	U06220010Q	1
12x1,75	U06220012Q	1
14x1,25 (3/8)	U06220014Q	1
14x1,25 (3/4)	U06220015Q	1
C12x1,25 (1/2)	U06220021Q	1
C12x1,25 (3/4)	U06220022Q	1



## 622 K12

### Thread repair kit for plugs

- To restore damaged threads M12-1,25
- Composed of inserts/tap/tool for installation of inserts and tang break-off
- Supplied in plastic case

M	LxPxH mm	code	
M12x1,25	190x70x30	U06220012	1

## 622 K14

### Thread repair kit for plugs

- To restore damaged threads M14-1,25
- Composed of Inserts/Tap/Tool for installation of inserts and tang break-off
- Supplied in plastic case



M	LxPxH mm	code	
M14x1,25	190x70x30	U06220014	1



## 630 AN

### Roll-up bag for home maintenance (19 pcs.)

- Nylon bag with belt fastener

pcs	description	item/size
1	Combination pliers	150 CX/180
1	Lay-on slip-joint adjustable pliers	178 N/250
1	Pincers for cement layers	199/225
1	Scissors for electricians	207 A
8	Double ended open jaw wrenches /6x7-8x9-10x11-12x13-14x15-16x17-18x19-20x22	252 N
1	Phase-testing screwdriver 110÷250V	321 F
2	Screwdrivers for slot-head screws /0,8x4x100-1,2x6,5x150	322
2	Screwdrivers for PHILLIPS® screws /1x100-2x125	322 PH
1	Hammers for mechanics	382/300
1	Oilers	418/70
1	Empty roll-up bag	630 AV

kg	code	
2,7	U06300010	1



## 630 BN

### Roll-up bag for motorcycle maintenance (20 pcs.)

- Nylon bag with belt fastener

pcs	description	item/size
1	Combination pliers	150 CX/180
1	T-handle spark plug wrenches with jointed socket	278 N/20,8
7	Set of 7 angled hexagon keys /2-2,5-3-4-4,5-5-6	280 S7
7	Combination wrenches/8-10-11-13-14-17-19	285
1	Reversible screwdriver for slot-head and PHILLIPS® screws	322 R/1x6x75
1	Oilers	418/70
2	Tyre levers	427/300
1	Empty roll-up bag	630 AV

kg	code	
2,2	U06300012	1



## 630 CN

### Roll-up bag for car maintenance (18 pcs.)

- Nylon bag with belt fastener

pcs	description	item/size
1	Combination pliers	150 CX/180
2	Hexagonal sockets/19-21	235 1/2 EN
1	Extensions	236 1/2/75
1	T-handle with sliding square drive	240 1/2 N
8	Double ended open jaw wrenches /6x7-8x9-10x11-12x13-14x15-16x17-18x19-20x22	252 N
1	T-handle spark plug wrenches with jointed socket	278 N/20,8
1	Reversible screwdriver for slot-head and PHILLIPS® screws	322 R/1x6x75
1	Hammers for mechanics	382/200
1	Oilers	418/70
1	Strap wrench for oil filters	444
1	Empty roll-up bag	630 AV

kg	code	
3	U06300014	1



## 630 AV

### Empty roll-up bag

- For assortments 630 AN, 630 BN, 630 CN, 630 DN

code	
U06300001	1



## 630 EN

### Folding bag for electrotechnics (17 pcs.)

- Plastic bag

pcs	description	item/size
1	Insulating tape	073/15x10
1	Half-round extra-long nose pliers with straight jaws	133 AX/160
1	Wire strippers	147 AX/160
1	Combination pliers	150 AX/160
1	Diagonal cutting nippers	185 AX/160
1	Scissors for electricians	207 A
1	Adjustable wrenches with quick adjustment	294 AD/150
1	Phase-testing screwdriver 110÷250V	321 F
4	Screwdrivers for slot-head screws/0,5x3x75-0,8x4x100-1x5,5x125-1x2x6,5x150	322
2	Screwdrivers for PHILLIPS® screws /1x80-2x125	322 PH
1	Chisels	362/150
1	Centre punches	368/4x125
1	Hammers for mechanics	382/200
1	Empty roll-up bag	630 EV

kg	code	
2,4	U06300018	1



## 630 EV

### Empty roll-up bag

- For assortment 630 EN

code	
U06300004	1



## 640 A

### Organizer (empty)

- Transparent cover: contents visible
- 8 removable compartments one of which can be further divided with the 2 dividers provided
- Compartments are blocked when cover is closed
- Plastic closing clips

LxPxH mm	kg	code	
422x335x106	1,5	U06400001	1



## 641 TA

### Tool box 16" (empty)

- One-hand opening system
- High resistant plastic material
- 2 compartments for small objects on the cover
- Possibility to close with a padlock (not supplied)
- Foldaway handle
- Inside removable tray

LxPxH mm	kg	code	
394x220x162	1,2	U06410004	1



## 641 TB

### Tool box 19" (empty)

- One-hand opening system
- High resistant plastic material
- 2 compartments for small objects on the cover
- Possibility to close with a padlock (not supplied)
- Foldaway handle
- Inside removable tray

LxPxH mm	kg	code	
486x266x236	2,1	U06410005	1





## 641 TC

### Tool box 24" (empty)

- One-hand opening system
- High resistant plastic material
- 2 compartments for small objects on the cover
- Possibility to close with a padlock (not supplied)
- Foldaway handle
- Inside removable tray

LxPxH mm	kg	code	
595x281x260	2,8	U06410006	1



## 646/2A

### Tool box 646/2V with assortment (30 pcs.)

- Sliding and removable tray
- Preset for padlock
- Sheet steel casing, anaphoretic process
- Inside dimensions: 447x207x102 mm

pcs	description	item/size
1	Lock-grip pliers with concave jaws	134/250
1	Combination pliers	150 CX/180
1	Lay-on slip-joint adjustable pliers	178 N/250
1	Diagonal cutting nippers	185 CX/160
17	Set of 17 combination wrenches /6-7-8-9-10-11-12-13-14-15-16-17-18-19-20-21-22	285 SE17
1	Adjustable wrenches with quick adjustment	294 AD/250
3	Screwdrivers for slot-head screws /0,5x3x75-0,8x4x100-1,2x6,5x150	324
2	Screwdrivers for PHILLIPS® screws / 1x75-2x100	324 PH
1	Chisels	362/150
1	Centre punches	368/4x125
1	Hammers for mechanics	382/300
1	Simple tool box (empty)	646/2V

LxPxH mm	kg	code	
480x240x110	6,5	U06460005	1



## 646/2V

### Simple tool box (empty)

- Sliding and removable tray
- Preset for padlock
- Sheet steel casing, anaphoretic process
- Inside dimensions: 447x207x102 mm

LxPxH mm	kg	code	
480x240x110	2,7	U06460001	1

## 646/2LV

### Simple tool box, long version (empty)

- Sliding and removable tray
- Preset for padlock
- Sheet steel casing, anaphoretic process
- Inside dimensions: 537x207x102 mm

LxPxH mm	kg	code	
565x220x110	3	U06460002	1



## 646/3A

### Tool box 646/3V with assortment (66 pcs.)

- Preset for padlock
- Sheet steel casing, anaphoretic process
- Inside dimensions: lower compartment 447x207x102 mm, compartments 447x103x52 mm

pcs	description	item/size
1	Combination pliers	150 CX/180
1	Lay-on slip-joint adjustable pliers	178 N/250
1	Heavy-duty diagonal cutting nippers	188 CX /160
21	Bihexagonal sockets /10-11-12-13-14-15-16-17-18-19-20-21-22-23-24-25-26-27-28-29-30-32	235 1/2 N
2	Extensions/125-250	236 1/2
1	T-handle with sliding square drive	240 1/2 N
1	Universal joint	241 1/2
13	Set of 13 double ended open jaw wrenches /6x7-8x9-10x11-12x13-14x15-16x17-18x19-20x22-21x23-24x26-25x28-27x29-30x32	252 N/SR13
13	Set of 13 offset bihexagonal ring wrenches /6x7-8x9-10x11-12x13-14x15-16x17-18x19-20x22-21x23-24x26-25x28-27x29-30x32	283 SE13
1	Adjustable wrenches with quick adjustment	294 AD/250
4	Screwdrivers for slot-head screws /0,5x3x75-0,8x4x100-1x5,5x125-1,2x6,5x150	324
2	Screwdrivers for PHILLIPS® screws / 1x75-2x100	324 PH
1	Chisels	362/150
1	Cross cut chisel	364/150
1	Drift punches	366/3x125
1	Centre punches	368/4x125
1	Hammers for mechanics	382/300
1	Cantilever tool box, three compartments (empty)	646/3V

LxPxH mm	kg	code	
480x220x185	10	U06460010	1



## 646/3V

### Cantilever tool box, three compartments (empty)

- Preset for padlock
- Sheet steel casing, anaphoretic process
- Inside dimensions: lower compartment 447x207x102 mm, compartments 447x103x52 mm

LxPxH mm	kg	code	
480x220x185	3,2	U06460101	1

## 646/3LV

### Long cantilever tool box, three compartments (empty)

- Preset for padlock
- Sheet steel casing, anaphoretic process
- Inside dimensions: lower compartment 537x207x102 mm, compartments 537x103x52 mm

LxPxH mm	kg	code	
565x220x185	3,7	U06460102	1



## 646/5A

### Cantilever tool box 646/5V with basic assortment 496 A2 (74 pcs.)

- Preset for padlock
- Sheet steel casing, anaphoretic process
- Inside dimensions: lower compartment 447x207x100 mm, compartments 447x103x52 mm

pcs	description	item/size
1	Basic assortment (74 pcs.)	496 A2
1	Cantilever tool box, five compartments (empty)	646/5V

LxPxH mm	kg	code	
480x240x220	20,6	U06460015	1



### 646/5AP

#### Cantilever tool box 646/5V with basic assortment 496 AP2, inch sizes (59 pcs.)

- Preset for padlock
- Sheet steel casing, anaphoretic process
- Inside dimensions:  
lower compartment 447x207x100 mm,  
compartments 447x103x52 mm

pcs description	item/size
1 Basic assortment (59 pcs.)	496 AP2
1 Cantilever tool box, five compartments (empty)	646/5V

LxPxH mm	kg	code	
480x240x220	19,6	U06460016	1



### 646/5V

#### Cantilever tool box, five compartments (empty)

- Preset for padlock
- Sheet steel casing, anaphoretic process
- Inside dimensions:  
lower compartment 447x207x100 mm  
compartments 447x103x52 mm

LxPxH mm	kg	code	
480x240x220	4,3	U06460201	1



**NEW**



### 646/5L

#### Long cantilever tool box 646/5LV with assortment (183 pz)

- Preset for padlock
- Sheet steel casing, anaphoretic process
- Inside dimensions:  
lower compartment 537x207x100 mm  
compartments 537x103x52 mm

pcs description	item/size
1 Combination pliers	150 AX/180
1 Box-joint adjustable pliers	180 C/250
1 Hacksaw	201
1 Scissors for electricians, steel blades	207 C
16 Set of 16 combination wrenches	285 J/B16
1 Adjustable wrenches with quick adjustment	294 AD/200
3 Screwdrivers for slot-head screws / 0,8x4x100-1x5,5x100-0,6x3,5x75	322
2 Screwdrivers for PHILLIPS® screws / 1x100-2x125	322 PH
1 Hammers for mechanics	382/400
34 Assortment with hexagonal sockets and bits in modular box 601 1/4 J34	
22 Assortment with hexagonal sockets in modular box 601 1/2 J22	
100 Assortment of bits with special shapes - 1/4"	692 J100
1 Long cantilever tool box, five compartments (empty)	646/5LV

LxPxH mm	kg	code	
565x240x220	16,6	U06468002E	1



### 646/5LV

#### Long cantilever tool box, five compartments (empty)

- Preset for padlock
- Sheet steel casing, anaphoretic process
- Inside dimensions:  
lower compartment 537x207x100 mm,  
compartments 537x103x52 mm

LxPxH mm	kg	code	
565x240x220	4,9	U06460301	1

UNI-ISO 1173 DIN 3126 C 6,3

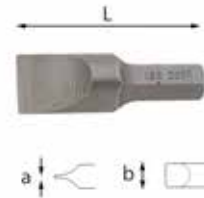

**660**

ISO 2351-1 ISO 1173

#### Bits for slot-head screws -1/4"

- Special Silicon Chrome Vanadium steel
- Oiled, sandblasted finish

axb mm	L mm	code	
0,5x4	25	U06600011	5
0,6x4,5	25	U06600012	5
0,8x5,5	25	U06600013	5
1x5,5	25	U06600014	5
1,6x8	25	U06600016	5
1,2x6,5	25	U06600015	5



**660 E**

ISO 2351-3 ISO 1173

#### Bits for hex socket screws -1/4"

- Special Silicon Chrome Vanadium steel
- Oiled, sandblasted finish

mm	L mm	code	
1,5	25	U06600408	5
2	25	U06600409	5
2,5	25	U06600401	5
3	25	U06600402	5
4	25	U06600403	5
5	25	U06600404	5
6	25	U06600405	5
7	25	U06600411	5
8	25	U06600406	5
10	25	U06600410	5



**660 PH**

ISO 2351-2 ISO 1173

#### Bits for PHILLIPS® screws -1/4"

- Special Silicon Chrome Vanadium steel
- Oiled, sandblasted finish

n°	L mm	code	
0	25	U06600107	5
1	25	U06600101	5
2	25	U06600102	5
3	25	U06600103	5
4	32	U06600105	5



### 660 PZ ISO 2351-2 ISO 1173

#### Bits for POZIDRIV® - SUPADRIV® screws -1/4"

- Special Silicon Chrome Vanadium steel
- Oiled, sandblasted finish

n°	L mm	code	
0	25	U06600207	5
1	25	U06600201	5
2	25	U06600202	5
3	25	U06600203	5
4	32	U06600205	5



### 660 TX ISO 1173

#### Bits for TORX® screws -1/4"

- Special Silicon Chrome Vanadium steel
- Oiled, sandblasted finish

n°	L mm	code	
T6	25	U06600301	5
T7	25	U06600302	5
T8	25	U06600303	5
T9	25	U06600304	5
T10	25	U06600305	5
T15	25	U06600306	5
T20	25	U06600307	5
T25	25	U06600308	5
T27	25	U06600309	5
T30	25	U06600310	5
T40	25	U06600311	5



### 660 STX ISO 1173

#### Bits for TORX® Tamper Resistant screws -1/4"

- For safety screws
- Special Silicon Chrome Vanadium steel
- Oiled, sandblasted finish

n°	L mm	code	
T10	25	U06600325	5
T15	25	U06600326	5
T20	25	U06600327	5
T25	25	U06600328	5
T27	25	U06600329	5
T30	25	U06600330	5
T40	25	U06600331	5



### 660 TPH ISO 1173

#### Bits for PHILLIPS® screws -1/4"

- Wear-resistant Titanium nitride coating
- Special Silicon Chrome Vanadium steel
- Gilt finish with oiled, sandblasted drive

n°	L mm	code	
1	25	U06600561	5
2	25	U06600562	5
3	25	U06600563	5



### 660 TAPH ISO 1173

#### Bits for PHILLIPS® screws -1/4"

- Wear-resistant Titanium nitride coating
- Anti-slip knurling
- Special Silicon Chrome Vanadium steel
- Gilt finish with oiled, sandblasted drive

n°	L mm	code	
1	25	U06600566	5
2	25	U06600567	5
3	25	U06600568	5



### 660 TPZ ISO 1173

#### Bits for POZIDRIV®-SUPADRIV® screws -1/4"

- Wear-resistant Titanium nitride coating
- Special Silicon Chrome Vanadium steel
- Gilt finish with oiled, sandblasted drive

n°	L mm	code	
1	25	U06600571	5
2	25	U06600572	5
3	25	U06600573	5



### 660 Q ISO 1173 ISO 1174-1

#### Socket-holder bit -1/4"

- Special Silicon Chrome Vanadium steel
- Oiled, sandblasted finish

"	L mm	code	
1/4	25	U06600400	5

### UNI-ISO 1173 DIN 3126 C 7,94



### 661 ISO 2351-1 ISO 1173

#### Bits for slot-head screws - 5/16"

- Special Silicon Chrome Vanadium steel
- Oiled, sandblasted finish

axb mm	L mm	code	
0,8x5,5	41	U06610001	5
1,2x6,5	41	U06610002	5
1,2x8	41	U06610003	5
1,6x10	41	U06610004	5
2x12	41	U06610005	5



### 661 E ISO 2351-3 ISO 1173

#### Bits for hex socket screws - 5/16"

- Special Silicon Chrome Vanadium steel
- Oiled, sandblasted finish

mm	L mm	code	
3	30	U06610401	5
4	30	U06610402	5
5	30	U06610403	5
6	30	U06610404	5
7	30	U06610407	5
8	30	U06610405	5
10	30	U06610406	5



### 661 PH ISO 2351-2 ISO 1173

#### Bits for PHILLIPS® screws - 5/16"

- Special Silicon Chrome Vanadium steel
- Oiled, sandblasted finish

n°	L mm	code	
1	32	U06610101	5
2	32	U06610102	5
3	32	U06610103	5
4	38	U06610104	5



### 661 PZ ISO 2351-2 ISO 1173

#### Bits for POZIDRIV®-SUPADRIV® screws - 5/16"

- Special Silicon Chrome Vanadium steel
- Oiled, sandblasted finish

n°	L mm	code	
1	32	U06610201	5
2	32	U06610202	5
3	32	U06610203	5
4	38	U06610204	5



### 661 TX ISO 1173

#### Bits for TORX® screws - 5/16"

- Special Silicon Chrome Vanadium steel
- Oiled, sandblasted finish

n°	L mm	code	
T27	35	U06610301	5
T30	35	U06610302	5
T40	35	U06610303	5
T45	35	U06610304	5
T50	35	U06610305	5
T55	35	U06610306	5



**664** 1/4 ISO 2351-1 ISO 1173

**Bits for slot-head screws - 1/4"**

- Direct fitting for electric and pneumatic tools
- Special Silicon Chrome Vanadium steel
- Oiled, sandblasted finish

axb mm	L mm	code	
0,5x3	50	U06640001	5
0,6x4	50	U06646002	5
0,6x4,5	50	U06640003	5
0,8x5	50	U06646004	5
0,8x5,5	50	U06646005	5
1x6	50	U06640006	5
1,2x8	50	U06640008	5
1,6x9	50	U06640009	5



**664 B** 1/4 ISO 1173

**Socket bits for hexagonal screws - 1/4"**

- Direct fitting for electric and pneumatic tools
- Special Silicon Chrome Vanadium steel
- Burnished finish

mm	L mm	code	
5,5	66	U06640002	5
7	66	U06640004	5
8	66	U06640005	5
10	66	U06640007	5
13	66	U06640010	5



**664 B/S7** 1/4

**Assortment with magnetic socket bits for hexagonal screws (7 pcs.) - 1/4"**

- Compact plastic box
- Base with foam cut-out
- Direct fitting for electric and pneumatic tools
- Hexagonal opening with magnet inside
- Magnetic socket bits: sizes 5,5-6-7-8-10-12-13 mm

LxPxH mm	gr	code	
138x98x30	300	U06640015	1



**664 E** 1/4 ISO 2351-3 ISO 1173

**Bits for hex socket screws - 1/4"**

- Direct fitting for electric and pneumatic tools
- Special Silicon Chrome Vanadium steel
- Oiled, sandblasted finish

mm	L mm	code	
3	50	U06640301	5
4	50	U06640302	5
5	50	U06640303	5
6	50	U06640304	5
8	50	U06640305	5
10	50	U06640306	5



**664 EL** 1/4 ISO 1173 ISO 2936

**Bits for hex socket screws - 1/4"**

- Direct fitting for electric and pneumatic tools
- Special Silicon Chrome Vanadium steel
- Oiled, sandblasted finish

mm	L mm	code	
2	70	U06640516	5
3	70	U06640517	5
4	70	U06640518	5
5	70	U06640519	5



**664 PH** 1/4 ISO 2351-2 ISO 1173

**Bits for PHILLIPS® screws - 1/4"**

- Direct fitting for electric and pneumatic tools
- Special Silicon Chrome Vanadium steel
- Oiled, sandblasted finish

n°	L mm	code	
1	50	U06640101	5
2	50	U06640102	5
3	50	U06640103	5
4	50	U06640104	5
1	75	U06640106	5
2	75	U06640107	5
1	100	U06640108	5
2	100	U06640109	5



**664 PZ** 1/4 ISO 2351-2 ISO 1173

**Bits for POZIDRIV®-SUPADRIV® screws - 1/4"**

- Direct fitting for electric and pneumatic tools
- Special Silicon Chrome Vanadium steel
- Oiled, sandblasted finish

n°	L mm	code	
1	50	U06640201	5
2	50	U06640202	5
3	50	U06640203	5
4	50	U06640204	5
1	75	U06640206	5
2	75	U06640207	5
1	100	U06640208	5
2	100	U06640209	5



**664 S4/75** 1/4

**Assortment in blister - 1/4" (4 pcs.)**

pcs	description	item/size
2	Bits for PHILLIPS® screws - 1/4"	664 PH/75
2	Bits for POZIDRIV®-SUPADRIV® screws - 1/4"	664 PZ/75

gr	code	
100	U06640110	1



**664 S4/100** 1/4

**Assortment in blister - 1/4" (4 pcs.)**

pcs	description	item/size
2	Bits for PHILLIPS® screws - 1/4"	664 PH/100
2	Bits for POZIDRIV®-SUPADRIV® screws - 1/4"	664 PZ/100

gr	code	
120	U06640210	1



### 664 TX

ISO 1173

#### Bits for TORX® screws - 1/4"

- Direct fitting for electric and pneumatic tools
- Special Silicon Chrome Vanadium steel
- Oiled, sandblasted finish

n°	L mm	code	
T6	70	U06640496	5
T7	70	U06640497	5
T8	70	U06640498	5
T9	70	U06640499	5
T10	70	U06640500	5
T15	70	U06640502	5
T20	70	U06640503	5
T25	70	U06640504	5
T27	70	U06640505	5
T30	70	U06640506	5
T40	70	U06640507	5



### 664 IP

ISO 1173

#### Bits for TORX PLUS® screws - 1/4"

- Direct fitting for electric and pneumatic tools
- Special Silicon Chrome Vanadium steel
- Oiled, sandblasted finish

n°	L mm	code	
IP6	70	U06640508	5
IP7	70	U06640509	5
IP8	70	U06640510	5
IP9	70	U06640511	5
IP10	70	U06640512	5
IP15	70	U06640513	5
IP20	70	U06640514	5
IP25	70	U06640515	5



### 664 Q

ISO 3317 ISO 1173

#### Socket-holder adapters - 1/4"

- Model with retaining pin (IMPACT)
- Direct fitting for electric and pneumatic tools
- Special Silicon Chrome Vanadium steel
- Oiled, sandblasted finish

"	L mm	code	
1/4	50	U06640401	5
3/8	50	U06640403	5



### 664 QS

ISO 3317 ISO 1173

#### Socket-holder adapters - 1/4"

- Model with retaining ball (MANUAL)
- Direct fitting for electric and pneumatic tools
- Special Silicon Chrome Vanadium steel
- Oiled, sandblasted finish

"	L mm	code	
1/4	50	U06640405	5
3/8	50	U06640406	5



### 664 S25

#### Assortment with long bits for impact wrenches - 1/4" (25 pcs.)

- Plastic box
- Base with foam cut-out
- Bits size and shape marked on the base
- Direct fitting for electric and pneumatic tools
- Magnetic bit-holder adapter included
- Contents:
  - 4 bits for slot-head screws 3-4-5-6 mm
  - 5 bits for PHILLIPS® screws PH 1-2(x2)-3(x2)
  - 5 bits for POZIDRIV® screws PZ 1-2(x2)-3(x2)
  - 5 bits for hex socket screws 2-3-4-5-5,5 mm
  - 5 bits for TORX® screws T15-T20-T25-T30-T40
  - 1 magnetic bit-holder adapter

LxPxH mm	g	code	
215x150x45	800	U06640111	1

### 5,5 UNI-ISO 1173 DIN 3126 A 5,5



### 670

ISO 1173 DIN 7427

#### Bit-holder adapter - 5,5 mm

- Direct fitting for electric and pneumatic tools
- Special Silicon Chrome Vanadium steel
- Oiled, sandblasted finish

"	L mm	code	
1/4	60	U06700001	1



### 670 MG

ISO 1173 DIN 7427

#### Magnetic bit-holder adapter - 5,5 mm

- Direct fitting for electric and pneumatic tools
- Special Silicon Chrome Vanadium steel
- Oiled, sandblasted finish

"	L mm	code	
1/4	79	U06700102	1

### 1/4 UNI-ISO 1173 DIN 3126 E 6,3



### 672

ISO 1173 DIN 7427

#### Bit-holder adapter - 1/4"

- Direct fitting for electric and pneumatic tools
- Special Silicon Chrome Vanadium steel
- Oiled, sandblasted finish

"	L mm	code	
1/4	60	U06720001	1



### 672 A

ISO 1173

#### Bit-holder adapter - 1/4"

- Model with quick-release sleeve
- Direct fitting for electric and pneumatic tools
- Special Silicon Chrome Vanadium steel
- Oiled, sandblasted finish with burnished collar

"	L mm	code	
1/4	51	U06720201	1



### 672 AMG

ISO 1173

#### Magnetic bit-holder adapter - 1/4"

- Model with quick-release sleeve
- Direct fitting for electric and pneumatic tools
- Special Silicon Chrome Vanadium steel
- Oiled, sandblasted finish with burnished collar

"	L mm	code	
1/4	52	U06720302	1



### 672 MG

ISO 1173 DIN 7427

#### Magnetic bit-holder adapter - 1/4"

- Direct fitting for electric and pneumatic tools
- Special Silicon Chrome Vanadium steel
- Oiled, sandblasted finish

"	L mm	code	
1/4	60	U06720102	1

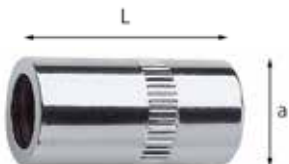

**684** ISO 1173 ISO 1174

**Bit-holder sockets**

- Socket 684/1 for use with bits of 660 series on manual tools
- Socket 684/6 for use with bits of 661 series on manual tools
- Special Chrome Vanadium steel
- Polished Chrome plated finish

n°	"	"	axL mm	code	
1	1/4	1/4	11x22	U06840001	1
6	1/2	5/16	23x37	U06840006	1



**685** ISO 1173 ISO 1177

**Impact bit-holder sockets**

- Socket 685/1 and 3 for use with bits of 660 series on electric and pneumatic tools
- Socket 685/4 and 6 for use with bits of 661 series on electric and pneumatic tools
- Socket 685/8 for use with bits of 687 series on electric and pneumatic tools
- Special Chrome Vanadium steel
- Phosphatized finish
- Employ safety pin 235 MCA/2 (U02350202Q) and locking ring 235 MDA/1 (U02350221Q) for 685/3 and 685/4
- Employ safety pin 235 MCA/4 (U02350204Q) and locking ring 235 MDA/4 (U02350224Q) for 685/6 and 685/8

n°	"	"	axL mm	code	
4	3/8	5/16	19x37	U06850004	1
6	1/2	5/16	25x40	U06850006	1
8	1/2	1/2	22x37	U06850008	1



**685 A** ISO 1173 ISO 1174

**Impact bit-holder sockets**

- Model with quick-release sleeve
- Socket 685 A/1 and 3 for use with bits of 660 series on electric and pneumatic tools
- Socket 685 A/4 and 6 for use with bits of 661 series on electric and pneumatic tools
- Special Chrome Vanadium steel
- Oiled sandblasted finish with burnished collar
- Employ safety pin 235 MCA/2 (U02350202Q) and locking ring 235 MDA/1 (U02350221Q) for 685 A/3 and 685 A/4
- Employ safety pin 235 MCA/4 (U02350204Q) and locking ring 235 MDA/4 (U02350224Q) for 685 A/6

n°	"	"	axL mm	code	
1	1/4	1/4	14x30	U06850101	1
3	3/8	1/4	19x43	U06850103	1
4	3/8	5/16	20x50	U06850104	1
6	1/2	5/16	24x50	U06850106	1

**ISO 1173 C 7,94**



**686** ISO 1173

**Impact bits for slot-head screws - 5/16" connection**

- To be used with electric or pneumatic tools
- Burnished finish

axb mm	L mm	code	
0,8x5,5	41	U06860001	1
1,2x6,5	41	U06860002	1
1,2x8	41	U06860003	1
1,6x10	41	U06860004	1
2x12	41	U06860005	1
2,5x14	41	U06860006	1



**686 E** ISO 1173

**Impact bits for hexagonal screws - 5/16" connection**

- To be used with electric or pneumatic tools
- Burnished finish

n°	L mm	code	
4	30	U06860035	1
5	30	U06860036	1
6	30	U06860037	1
8	30	U06860038	1
10	30	U06860039	1



**686 PH** ISO 1173

**Impact bits for PHILLIPS® screws - 5/16" connection**

- To be used with electric or pneumatic tools
- Burnished finish

n°	L mm	code	
1	32	U06860020	1
2	32	U06860021	1
3	32	U06860022	1
4	32	U06860023	1



**686 PZ** ISO 1173

**Impact bits for POZIDRIV® - SUPADRIV® screws - 5/16" connection**

- To be used with electric or pneumatic tools
- Burnished finish

n°	L mm	code	
2	32	U06860025	1
3	32	U06860026	1
4	32	U06860027	1



**686 TX** ISO 1173

**Impact bits for TORX® screws - 5/16" connection**

- To be used with electric or pneumatic tools
- Burnished finish

n°	L mm	code	
T20	35	U06860050	1
T25	35	U06860051	1
T27	35	U06860052	1
T30	35	U06860053	1
T40	35	U06860054	1
T45	35	U06860055	1
T50	35	U06860056	1
T55	35	U06860057	1

**ISO 1173 C 12,7**



**687** ISO 1173

**Impact bits for slot-head screws - 1/2" connection**

- To be used with electric or pneumatic tools
- Burnished finish

axb mm	L mm	code	
2x12	50	U06870001	1
2,5x15	50	U06870002	1
2,5x16	50	U06870003	1



**687 E** ISO 1173

**Impact bits for hexagonal screws - 1/2" connection**

- To be used with electric or pneumatic tools
- Burnished finish

mm	L mm	code	
3	50	U06870010	1
4	50	U06870011	1
5	50	U06870012	1
6	50	U06870013	1
7	50	U06870014	1
8	50	U06870015	1
10	50	U06870016	1
11	50	U06870017	1
12	50	U06870018	1
14	50	U06870019	1
17	50	U06870020	1
19	50	U06870021	1



**687 TX** ISO 1173

**Impact bits for TORX® screws - 1/2" connection**

- To be used with electric or pneumatic tools
- Burnished finish

n°	L mm	code	
T25	50	U06870040	1
T27	50	U06870041	1
T30	50	U06870042	1
T40	50	U06870043	1
T45	50	U06870044	1
T50	50	U06870045	1

## 687 TX

n°	L mm	code	
T55	50	U06870046	1
T60	50	U06870047	1
T70	50	U06870048	1



1/2

## 687 1/2" C16

### Assortment with IMPACT bits in ABS case (16 pcs.)

- High resistance ABS case with quick closing system
- The inside tray is studied to be stored in USAG roller cabinet drawers
- Empty inner plastic tray: code U05190687Q

pcs	description	item/size
1	Impact bit-holder sockets	685/1/2-1/2
1	Impact bit-holder sockets	685/1/2-5/16
3	Impact bits for PHILLIPS® screws - 5/16" connection	686 PH/2-3-4
5	Impact bits for TORX® screws - 1/2" connection /T30-T40-T45-T50-T55	687 TX
1	Plastic tray (empty)	519/687C16V
1	Empty ABS case - size S	606 S

LxPxH mm	g	code	
210x130x60	668	U06870100	1



## 685 B

### Holder for impact bits

- Socket 685 B/1 and 685 B/3 for use with bits of 688 E series on electric and pneumatic tools
- Socket 685 B/4 and 685 B/6 for use with bits of 689 E series on electric and pneumatic tools
- Special Chrome Vanadium steel
- Phosphatized finish
- Employ safety pin 235 MCA/8 (U02350207Q) and locking ring 235 MDA/8 (U02350227Q) for 685 B/1
- Employ safety pin 235 MCA/9 (U02350208Q) and locking ring 235 MDA/9 (U02350228Q) for 685 B/3 and 685 B/4
- Employ safety pin 235 MCA/10 (U02350209Q) and locking ring 235 MDA/10 (U02350229Q) for 685 B/6

n°	"	Ø	axL mm	code	
1	3/4	7/8	44x54	U06850110	1
3	1	7/8	54x60	U06850115	1
4	1	1 1/2	58x70	U06850120	1

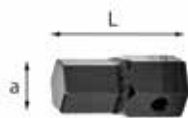

## 688 E

### Impact bits for hexagonal screws - 7/8" connection

- To be used with electric or pneumatic tools
- Burnished finish

● mm	a mm	L mm	code	
12	21	50	U06880001	1
14	21	50	U06880002	1
17	21	50	U06880003	1
19	21	50	U06880004	1
22	20	50	U06880005	1
24	21	50	U06880006	1



## 689 E

### Impact bits for hexagonal screws - 1.1/2" connection

- To be used with electric or pneumatic tools
- Burnished finish

● mm	a mm	L mm	code	
27	27	75	U06890027	1
30	30	76	U06890030	1
32	35	78	U06890032	1



3/4

## 688 3/4" MD6

### Assortment with IMPACT bits in ABS case (16 pcs.)

- High resistance ABS case with quick closing system
- The inside tray is studied to be stored in USAG roller cabinet drawers
- Empty inner plastic tray: code U05190743Q

pcs	description	item/size
1	Holder for impact bits/3/4-7/8	685 B
5	Impact bits for hexagonal screws - 7/8" connection/12-17-19-22-24	688 E
1	Empty ABS case - size S	606 S

LxPxH mm	g	code	
210x130x60	1,4	U06880010	1



## 690 1/4" C28

### Assortment with bits in ABS case (28 pcs.)

- Magnetic bit-holder included
- High resistance ABS case with quick closing system
- The inside tray is studied to be stored in USAG roller cabinet drawers
- Empty inner plastic tray: code U06900002Q

pcs	description	item/size
3	Bits for slot-head screws -1/4" / 0,6x4,5-1x5,5-1,2x6,5	660
6	Bits for hex socket screws -1/4" / 2-2,5-3-4-5-6	660 E
4	Bits for PHILLIPS® screws -1/4" / 1-2-3-4	660 PH
4	Bits for POZIDRIV® - SUPADRIV® screws -1/4" / 1-2-3-4	660 PZ
6	Bits for TORX® Tamper Resistant screws -1/4"/T10-T15-T20-T25-T30-T40	660 STX
4	Bits for TORX® screws -1/4"/ T6-T7-T8-T9	660 TX
1	Magnetic bit-holder with grip	690 A 1/4/180
1	Plastic tray (empty)	519/690C28V
1	Empty ABS case - size S	606 S

LxPxH mm	g	code	
210x130x60	700	U06900015	1



## 690 A 1/4"

### Magnetic bit-holder with grip

- Ergonomic three-material grip with soft coating, resistant to oils and chemicals
- Chrome Vanadium steel body
- Chrome plated finish

L mm	a mm	g	handle size	code	
180	63	120	M3	U06900102	1
245	128	150	M3	U06900103	1



## 692 J32

### Assortment with bits and reversible ratchet - 1/4" (32 pcs.)

- Compact plastic box
- Base with shaped foam
- Magnetic bit-holder adapter and magnetic reversible ratchet included

#### pcs description

4	Bits for slot-head screws 4-5,5-6,5-8
3	Bits for PHILLIPS® screws PH 1-2-3
3	Bits for POZIDRIV® screws PZ 1-2-3
4	Bits for hex socket screws 3-4-5-6 mm
9	TORX® bits T8-T10-T15-T20(x2)-T25(x2)-T30-T40
7	TORX® tamper resistant bits T10-T15-T20-T25-T27-T30-T40
1	Magnetic bit-holder adapter 1/4"
1	Magnetic reversible ratchet 1/4"

LxPxH mm	g	code	
138x98x30	280	U06920042	1



## 692 J49

### Assortment with bits - 1/4" (49 pcs.)

- Compact plastic box
- Base with shaped foam
- Magnetic bit-holder adapter included

#### pcs description

6	Bits for slot-head screws 4-4,5-5,5-6,5(x2)-8
6	Bits for PHILLIPS® screws PH 1(x2)-2(x3)-3
7	Bits for POZIDRIV® screws PZ 1(x2)-2(x3)-3(x2)
9	Bits for hex socket screws 2-3(x2)-4(x2)-5(x2)-6(x2) mm
10	TORX® bits T10(x2)-T15(x2)-T20(x2)-T25(x2)-T30(x2)
10	TORX® Tamper Resistant bits T10-T15(x2)-T20(x2)-T25(x2)-T30(x2)-T40
1	Magnetic bit-holder adapter 1/4"

LxPxH mm	g	code	
138x98x30	280	U06920041	1



## 692 J100

### Assortment of bits with special shapes - 1/4" (100 pcs.)

- It contains standard and special bits for working on appliances, electronic equipments, etc ...
- Plastic box
- Bits retaining system inside
- Bits size and shape marked inside
- 2 magnetic bit-holder adapters included

#### pcs description

9	Bits for slot-head screws 3-4-4,5-5,5-6-6,5-7-8
8	Bits for PHILLIPS® screws PH 00-0-1(x2)-2(x2)-3-4
5	Bits for POZIDRIV® screws PZ 1-2(x2)-3-4
10	Bits for hex socket screws 1,5-2-2,5-3-4-5-5,5-6-7-8 mm
10	Bits for hex socket screws 1/16-5/64-3/32-7/64-1/8-9/64-5/32-3/16-7/32-1/4
10	TORX® bits T8-T9-T10-T15-T20-T25-T27-T30-T40-T45
9	TORX® Tamper Resistant bits T8-T10-T15-T20-T25-T27-T30-T35-T40
4	Tri-Wing bits 1-2-3-4
5	Spanner bits 4-6-8-10-12
3	Torq-set bits 6-8-10
5	Square bits 0-1-2(x2)-3
5	Clutch bits 1/8-5/32-3/16-1/4-5/16
3	Bits XZN M5-M6-M8
6	Bits for hex socket screws with holes 2-2,5-3-4-5-6
6	Bits for hex socket screws with holes 5/64-3/32-7/64-1/8-9/64-5/32
2	Magnetic bit-holder adapter 1/4"

LxPxH mm	g	code	
215x150x45	900	U06920043	1



## 692 S11

### Assortment in plastic box - 1/4" (11 pcs.)

pcs description	item/size
3 Bits for slot-head screws -1/4" / 0,6x4,5-0,8x5,5-1,2x6,5	660
4 Bits for PHILLIPS® screws -1/4" / 0-1-2-3	660 PH
3 Bits for POZIDRIV® - SUPADRIV® screws -1/4"/1-2-3	660 PZ
1 Magnetic bit-holder adapter - 1/4"	672 MG

g	code	
100	U06920021	1



## 692 STX/S11

### Assortment in plastic box - 1/4" (11 pcs.)

pcs description	item/size
10 Bits for TORX® Tamper Resistant screws -1/4" / 10-15-20(x2)-25(x2)-27-30-40(x2)	660 STX
1 Magnetic bit-holder adapter - 1/4"	672 MG

g	code	
110	U06920026	1



## 692 SP1

### Assortment of bits (8 pcs.)

- Set of bits with central hole to disassemble air mass gauges and injection pumps
- Composed by a bit holder (1/4 - 5/16") and 7 bits (TS-10 / TS-15 / TS-20 / TS-25 / TS-27 / TS-30 / TS-40)

g	code	
120	U06920001	1



## 692 SP3

### Assortment with Ribe bits with hole - XZN - TORX® Tamper Resistant (40 pcs.)

- Set with 40 short and long bits for RIBE screws with hole, XZN, TORX® Tamper Resistant composed by:
- Ribe with hole M5-6-7-8-9-10-12 L=30mm) (M5-6-7-8-9-10-12 L=75mm)
- XZN (M5-6-8-10-12 L=30mm) (M5-6-8-10-12 L=75mm)
- TORX® Tamper Resistant (STX20-25-30-40-45-50-55 L=30mm) (STX20-25-30-40-45-50-55 L=75mm)
- 10mm connection
- Two adapters 3/8"-1/2"
- Supplied in metal box with inside tray

LxPxH mm	kg	code	
340x170x40	2,2	U06920032	1





### 692 RB

#### Bits for splined hexagonal screws (RIBE with hole)

- Manual use
- Silicon Vanadium Steel
- 10 mm connection
- Inserts contained within the 692 SP3 kit

n°	L mm	code	
4-5-6	30	U06920010Q	1
7-8-9	30	U06920011Q	1
10-12-13	30	U06920012Q	1
4-5-6	75	U06920013Q	1
7-8-9	75	U06920014Q	1
10-12-13	75	U06920015Q	1



### 692 ZXN

#### Bits for ZXN screws

- Manual use
- Silicon Vanadium Steel
- 10 mm connection
- Inserts contained within the 692 SP3 kit

n°	L mm	code	
5-6-8	30	U06920016Q	1
10-12	30	U06920017Q	1
5-6-8	75	U06920018Q	1
10-12	75	U06920019Q	1



### 692 TX

#### Bits for TORX® Tamper Resistant screws

- Manual use
- Silicon Vanadium Steel
- 10 mm connection
- Inserts contained within the 692 SP3 kit

n°	L mm	code	
20-25-30	30	U06920020Q	1
40-45	30	U06920021Q	1
50-55	30	U06920022Q	1
20-25-30	75	U06920023Q	1
40-45	75	U06920024Q	1
50-55	75	U06920025Q	1



### 692 A

#### Set with 2 bit-holder sockets

- Manual use
- Silicon Vanadium Steel
- To be used with 10 mm hexagonal inserts
- Bit holder bushes contained in the 692 SP3 kit

code	
U06920026Q	1



### 695 1/2"

#### Impact screwdriver

- For loosening rusted or locked screws
- Driving direction can be adjusted by turning the grip
- Special Chrome Vanadium steel
- Zinc Chrome plated finish

L mm	a mm	code	
160	32	U06950001	1



### 700 1/2" C6

#### Assortment with impact screwdriver in ABS case (6 pcs.)

- High resistance ABS case with quick closing system
- The inside tray is studied to be stored in USAG roller cabinet drawers
- Empty inner plastic tray: code U07000002Q

pcs	description	item/size
2	Bits for slot-head screws - 5/16" / 1,2x8-1,6x10	661
2	Bits for PHILLIPS® screws - 5/16" / 2-3	661 PH
1	Impact bit-holder sockets	685/6
1	Impact screwdriver	695 1/2
1	Plastic tray (empty)	519/700V
1	Empty ABS case - size S	606 S

LxPxH mm	kg	code	
210x130x60	1,2	U07000085	1



### 746

#### Crimping pliers for non-insulated open and closed terminals

- Model with screw-cutter, wire-cutter and wire-stripper
- PVC handgrip
- Body in cut sheet steel

L mm	mm²	code	
235	0,5÷1 1,5÷2,5 4÷6	U07460001	5



### D 746

#### Crimping pliers for non-insulated open and closed terminals

L mm	mm²	code	
235	0,5÷1 1,5÷2,5 4÷6	U07460001D	1



### 747

#### Crimping pliers for pre-insulated terminals

- Model with screw-cutter, wire-cutter and wire-stripper
- PVC handgrip
- Body in cut sheet steel

L mm	mm²	code	
235	0,5÷1 1,5÷2,5 4÷6	U07470001	5



### 748

DIN 46247-46248

#### Crimping pliers for non-insulated open terminals

- Jaws in microcast steel
- Body in pressed sheet steel

L mm	mm²	code	
227	0,25÷0,5 0,5÷1,0 1,5÷2,5 4÷6	U07480001	1



### D 748

#### Crimping pliers for non-insulated open terminals

L mm	mm²	code	
227	0,25÷0,5 0,5÷1,0 1,5÷2,5 4÷6	U07480001D	1



### 749 DIN 46230-46234

#### Crimping pliers for non-insulated closed terminals

- Jaws in microcast steel
- Body in pressed sheet steel

L mm	mm <sup>2</sup>	code	
227	0,1-0,35 0,5-1,0 1,5-2,5 4-6 10-16	U07490001	1



### D 749

#### Crimping pliers for non-insulated closed terminals

L mm	mm <sup>2</sup>	code	
227	0,1-0,35 0,5-1,0 1,5-2,5 4-6 10-16	U07490001D	1



### 751

#### Crimping pliers for pre-insulated terminals

- Rack model for progressive and calibrated crimping pressure, with automatic jaw opening at the end of tightening
- PVC handgrips
- Jaws in microcast steel
- Sheet steel body

L mm	mm <sup>2</sup>	code	
215	0,5÷1 1,5÷2,5 4÷6	U07510002	1



### D 751

#### Crimping pliers for pre-insulated terminals

L mm	mm <sup>2</sup>	code	
215	0,5÷1 1,5÷2,5 4÷6	U07510002D	1



### 753

#### Crimping pliers for cable tip terminals

- Rack-type model with frontal insertion and automatic reopening of jaws at the end of the compression
- PVC handles
- Jaws in microcast steel
- Body in pressed sheet steel

L mm	mm <sup>2</sup>	code	
225	0,25÷6	U07530002	1



### 753 A

#### Crimping pliers for cable tip terminals

- Rack-type model for reducing the compression effort
- Ergonomic PVC grip which facilitates one-handed tightening
- Stainless steel mould with 5 shapes
- Sheet steel body

L mm	mm <sup>2</sup>	code	
228	0,5÷1-1,5-2,5-4-6	U07530003	1



### 753 KA

#### Self-adjusting crimping pliers for square terminals

- For insulated and non-insulated terminals
- Capacity 0,14-10 mm<sup>2</sup>/AWG 26-8
- Opening system for multiple consecutive operations
- Allows to crimp applying little force on the handles
- Low weight and compact size for easy handling

mm <sup>2</sup>	L mm	code	
0,14÷10	230	U07530004	1



### 754 A

#### Crimping pliers with interchangeable moulds

- Moulds easy to be replaced
- Handles at 90° for greater visibility during use
- Big levers for a reduced effort and for use with one or two hands
- Supplied with 2 moulds:
  - for pre-insulated terminals, 0,1 to 6 mm<sup>2</sup> / AWG 26-10 (green, yellow)
  - for pre-insulated terminals, 0,5-2,5 mm<sup>2</sup> / AWG 22-14 (blue, red)

mm <sup>2</sup>	L mm	code	
0,1÷6 - 0,5÷2,5	230	U07540002	1



### 754 MA

#### Spare mould

- For pre-insulated terminals 0,5-2,5 mm<sup>2</sup>/AWG 22-14 (blue, red)

mm <sup>2</sup>	code	
0,5÷2,5	U07540002Q	1



### 754 MB

#### Spare mould

- For pre-insulated terminals 0,1-6 mm<sup>2</sup>/AWG 26-10 (green, yellow)

mm <sup>2</sup>	code	
0,1÷6	U07540003Q	1



### 754 MC

#### Spare mould

- For cable-tip terminals 0,25-10 mm<sup>2</sup>/AWG 24-8

mm <sup>2</sup>	code	
0,25÷10	U07540004Q	1



### 754 MD

#### Spare mould

- For non-insulated cable-tip terminals 0,5-6 mm<sup>2</sup>/AWG 22-10

mm <sup>2</sup>	code	
0,5÷6	U07540005Q	1



### 765

#### Cable ties pliers

- Model for nylon straps up to 9 mm wide

- Blade for cutting the projecting length

- Body in pressed sheet steel

L mm	code	
195	U07650001	1

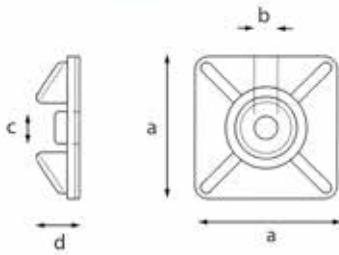

## 765 A CE

LVD 2014/35/EU

### Two-way baseplates

- Model with adhesive for strips up to 4.8 mm wide
- Material: ABS
- Good resistance to bases, greases
- Limited resistance to acids
- Not resistant to solvents, thinners, petroleum products
- Pack of 100 pcs.

characteristics	size
Self-extinguishing	UL 94 - HB
Humidity absorption	0,1%
Operating temperature (°C)	-10° ÷ +60°C

n°	colour	axbxc mm	d mm	code	
1	neutro	27x6x4,8	8	U07650072	1
2	nero	27x6x4,8	8	U07650074	1

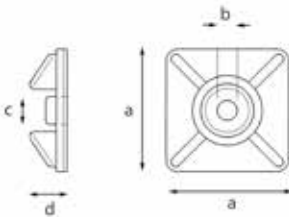

## 765 B CE

LVD 2014/35/EU

### Two-way baseplates

- Model without adhesive for strips up to 4.8 mm wide
- Material: ABS
- Good resistance to bases, greases
- Limited resistance to acids
- Not resistant to solvents, thinners, petroleum products
- Pack of 100 pcs.

characteristics	size
Self-extinguishing	UL 94 - HB
Humidity absorption	0,1%
Operating temperature (°C)	-10° ÷ +60°C

a mm	b mm	c mm	d mm	code	
27	6	4,8	6,5	U07650076	1

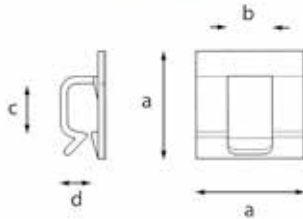

## 765 C CE

LVD 2014/35/EU

### Supports for round cables

- Model with adhesive
- Material: Polyamide 6.6
- Excellent resistance to aromatic solvents, oils, greases, petroleum products
- Good resistance to bases
- Limited resistance to acids
- Not resistant to phenols and chlorinated solvents
- Pack of 100 pcs.

characteristics	size
Self-extinguishing	UL 94 - V2
Humidity absorption	2,7 ÷ 2,8%
Operating temperature (°C)	-40° ÷ +85° C

n°	axbxc mm	d mm	code	
5	19x10x6	5	U07650101	1
8	27x12x12	8	U07650102	1

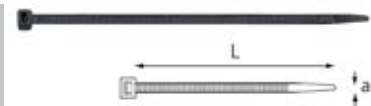

## 765 EN CE

LVD 2014/35/EU

### Cable ties

- Material: Polyamide 6.6
- Excellent resistance to aromatic solvents, oils, greases, petroleum products
- Good resistance to bases
- Limited resistance to acids
- Not resistant to phenols and chlorinated solvents
- Pack of 100 pieces

characteristics	size
Self-extinguishing	UL 94 - V2
Humidity absorption	2,7% - 2,8% (23°C - 50% R.H.)
Installation temperature	-10°C ÷ +60°C
Operating temperature (°C)	-40°C ÷ +85°C

axL mm	Ø max	code	
2,5x98	21	U07650051	1
2,6x135	32	U07650060	1
2,6x200	52	U07650061	1
3,6x140	35	U07650052	1
3,6x200	50	U07650062	1
3,6x290	80	U07650063	1
4,8x178	45	U07650053	1
4,8x200	50	U07650054	1
4,8x290	79	U07650055	1
4,8x360	100	U07650056	1
7,8x240	63	U07650057	1
7,8x365	100	U07650058	1
7,8x540	158	U07650064	1
7,8x750	200	U07650059	1



## 767

### Universal cross-type wrench

- For cabinets and technical fittings
- 9 different shapes
- Double sockets orientable and reversible
- Slot-head and PHILLIPS® shape with tap and hanging chain
- Hanging hole

à gr	code	
200	U07670001	1



## 810 N

ISO 6789

### Torque wrenches with reversible ratchet

- Adjustable torque model for clockwise tightening
- Accuracy ± 4% of the preset torque value
- Readings in Nm
- Sensible and audible alarm on reaching preset torque value
- Automatic resetting on pressure release after disengagement
- Supplied with test certificate

capacity Nm	resolution Nm	"	L mm	code	
1÷5	0,05	1/4	197	U08104000	1
5÷25	0,05	1/4	290	U08104001	1



ISO 6789

## 810 SA

ASME B107.300-2021

### Direct read torque wrench with reversible ratchet

- Click torque wrench
- Automatic resetting: ready to be use after the click
- Adjustable torque for clockwise tightening
- Accuracy  $\pm$  4% of the preset torque value
- Direct read system: you can see quickly the preset torque value
- Spring compressor mechanism
- Inside mechanism protected by the steel tube
- Double readings: Nm/ft.lb
- Reversible ratchet with 72 theet mechanism
- Ergonomic handle with soft touch feeling, resistant to oils and chemicals
- No slipping design of the handle
- Delivered in plastic tube packaging
- Calibration certificate and REACH (SVHC) declaration included

capacity Nm	resolution Nm	"	L mm	code	
10÷50	0,25	3/8	350	U08105002	1
20÷100	0,5	1/2	410	U08105003	1
40÷200	1	1/2	475	U08105005	1
68÷340	1	1/2	630	U08105006	1



ISO 6789

## 811 N

### Torque rod

- Adjustable torque model for use in combination with fittings from the 811-series
- For clockwise and counterclockwise tightening by turning the fittings 180°
- 9x12 or 14x18 mm fittings
- Accuracy  $\pm$  4% of the preset torque value
- Readings in Nm
- Sensible and audible alarm on reaching preset torque value
- Automatic resetting on pressure release after disengagement
- Supplied with test certificate

capacity Nm	resolution Nm	mm	L mm	code	
1÷5	0,05	9x12	185	U08114000	1
5÷25	0,05	9x12	270	U08114001	1



ISO 6789

## 811 SA

ASME B107.300-2021

### Direct read torque bar

- Click torque wrench
- Model without ratchet for use in combination with fittings from the 811 series
- 9x12 or 14x18 mm fittings
- Automatic resetting: ready to be use after the click
- Adjustable torque for clockwise tightening
- Accuracy  $\pm$  4% of the preset torque value
- Direct read system: you can see quickly the preset torque value
- Spring compressor mechanism
- Inside mechanism protected by the steel tube
- Double readings: Nm/ft.lb
- Ergonomic handle with soft touch feeling, resistant to oils and chemicals
- No slipping design of the handle
- Delivered in plastic tube packaging
- Calibration certificate and REACH (SVHC) declaration included

capacity Nm	resolution Nm	mm	L mm	code	
10÷50	0,25	9x12	335	U08115002	1
20÷100	0,5	9x12	395	U08115003	1
40÷200	1	14x18	460	U08115004	1
68÷340	1	14x18	615	U08115006	1



ISO 6789

## 811 NE

### Torque wrenches with removable reversible ratchet

- Adjustable torque model for use in combination with fittings from the 811-series
- For clockwise and counterclockwise tightening by turning the fittings 180°
- 9x12 or 14x18 mm fittings
- Accuracy  $\pm$  4% of the preset torque value
- Readings in Nm
- Sensible and audible alarm on reaching preset torque value
- Automatic resetting on pressure release after disengagement
- Supplied with test certificate
- Complete with reversible ratchet 811 E with 72 teeth

capacity Nm	resolution Nm	"	mm	L mm	code	
1÷5	0,05	1/4	9x12	185	U08114009	1
5÷25	0,05	1/4	9x12	300	U08114010	1



ISO 6789

## 811 SE

ASME B107.300-2021

### Direct read torque wrench with removable ratchet

- Click torque wrench
- Model with removable ratchet for use also in combination with fittings from the 811 series
- 9x12 or 14x18 mm fittings
- Automatic resetting: ready to be use after the click
- For clockwise and counterclockwise tightening by turning the ratchet head 180°
- Adjustable torque for clockwise tightening
- Accuracy  $\pm$  4% of the preset torque value
- Direct read system: you can see quickly the preset torque value
- Spring compressor mechanism
- Inside mechanism protected by the steel tube
- Double readings: Nm/ft.lb
- Ergonomic handle with soft touch feeling, resistant to oils and chemicals
- No slipping design of the handle
- Delivered in plastic tube packaging
- Calibration certificate and REACH (SVHC) declaration included

capacity Nm	resolution Nm	"	mm	L mm	code	
10÷50	0,25	3/8	9x12	370	U08115012	1
20÷100	0,25	3/8	9x12	430	U08115013	1
20÷100	0,25	1/2	9x12	430	U08115015	1
40÷200	0,5	1/2	14x18	510	U08115017	1
68÷340	1	1	14x18	665	U08115018	1



ISO 6789

## 811 LB

### Click-type torque bars

- Model without ratchet for use in combination with fittings from the 811 series
- 9x12 or 14x18 mm fittings
- Automatic resetting: ready to be use after the click
- Adjustable torque for clockwise tightening
- Accuracy  $\pm$  2% of the preset torque value
- Spring compressor mechanism
- Reliability of mechanism: 50.000 cycles (wrenches up to 200 Nm)
- Inside mechanism protected by the steel tube
- Single reading scale (Nm) engraved on the wrench body
- Ergonomic handle with soft touch feeling, resistant to oils and chemicals
- Steel adjustment ring
- Delivered in plastic tube packaging

capacity Nm	resolution Nm	mm	L mm	code	
10÷50	1	9x12	357	U08115021	1
20÷100	1	9x12	437	U08115023	1
40÷200	1	14x18	515	U08115024	1
70÷350	2	14x18	725	U08115025	1



**NEW**



**811 LBE**

ISO 6789

**Click torque wrench with removable ratchet**

- Model with removable ratchet for use also in combination with fittings from the 811 series
- 9x12 or 14x18 mm fittings
- Automatic resetting: ready to be use after the click
- Adjustable torque for clockwise tightening
- Accuracy  $\pm 2\%$  of the preset torque value
- Spring compressor mechanism
- Reliability of mechanism: 50.000 cycles (wrenches up to 200 Nm)
- Inside mechanism protected by the steel tube
- Single reading scale (Nm) engraved on the wrench body
- Reversible ratchet head with 72 teeth mechanism (811 E)
- Ergonomic handle with soft touch feeling, resistant to oils and chemicals
- Steel adjustment ring
- Delivered in plastic tube packaging

capacity Nm	resolution Nm	"	O mm	L mm	code	
10÷50	1	3/8	9x12	407	U08115026	1
20÷100	1	3/8	9x12	487	U08115027	1
20÷100	1	1/2	9x12	487	U08115028	1
40÷200	1	1/2	14x18	565	U08115029	1
70÷350	2	1/2	14x18	775	U08115032	1



1/2

**811 NE 200**

**Assortment with torque wrench in sheet steel case (7 pcs.)**

- Closing clip and carrying handle
- The inside tray is studied to be stored in USAG roller cabinet drawers
- Empty bi-colour foam module: code U05190995Q, U05190996Q
- Empty sheet steel box: code U06120004Q

pcs	description	item/size
1	Reversible ratchet with 72 teeth	811 E/1/2
5	Open jaw wrenches/13-17-19-22-24	811 G
1	Torque rod	811 N/40÷200
1	Bi-colour foam module (empty)	519 M 811GV
1	Bi-colour foam module (empty)	519 M 811NDV
1	Sheet steel box (empty) - size XL	612 XL

LxPxH mm	kg	code	
425x395x83	6	U08112005	1

**811 E**



**Reversible ratchet with 72 teeth**

- 811 E 3/4" reversible ratchet for 812 N 600

"	O mm	code	
1/4	9x12	U08110010	1
3/8	9x12	U08111010	1
R1/2	9x12	U08112010	1
1/2	14x18	U08112011	1
3/4	14x18	U08113010	1

**811 F**



**Open jaw wrenches**

- Fitting 9x12 mm

O mm	code	
8	U08115005	1
10	U08115007	1
12	U08115009	1
13	U08115010	1
14	U08115011	1
17	U08115014	1
19	U08115016	1

**811 G**



**Open jaw wrenches**

- Fitting 14x18 mm

O mm	code	
13	U08115030	1
14	U08115031	1
17	U08115034	1
19	U08115036	1
22	U08115039	1
24	U08115041	1

**811 H**



**Bihexagonal ring wrenches**

- Fitting 9x12 mm

O mm	code	
8	U08115105	1
10	U08115107	1
12	U08115109	1
13	U08115110	1
14	U08115111	1
17	U08115114	1
19	U08115116	1

**811 K**



**Bihexagonal ring wrenches**

- Fitting 14x18 mm

O mm	code	
13	U08115130	1
14	U08115131	1
17	U08115134	1
19	U08115136	1
22	U08115139	1
24	U08115141	1



by **FACOM**

NF EN ISO 6789

ISO 6789 DIN EN ISO 6789

**811 RF**

**Manual click wrenches with removable ratchet**

- Accuracy  $\pm 6\%$  of the preset torque value
- Graduated in daNm
- Numbered keys supplied in plastic case with ratchet and ISO 6789 calibration certificate

capacity daNm	"	L mm	code	
4÷20	1/2	470	U08114935	1



by **FACOM**

NF EN ISO 6789

ISO 6789 DIN EN ISO 6789

**811 RAL**

**Click torque wrenches with dual lbf.in or lbf.ft and Nm graduation**

- Model with 72 teeth and an angle of action of 5°
- Accuracy  $\pm 2\%$  of the preset torque value
- Reliability of mechanism: 50.000 cycles
- Dual lbf.in or lbf.ft and Nm graduation
- Reversible ratchet
- To be used with 9x12 or 14x18 mm fittings
- Full metal wrenches with knurled handle
- Numbered wrenches supplied with ISO 6789 calibration certificate
- Supplied in a plastic box with ratchet

capacity Nm	capacity lbf.in	capacity lbf.ft	resolution lbf.in	resolution lbf.ft	"
340	-	30-250	-	1	1/2

capacity Nm	O mm	L mm	code	
40,6÷340	14x18	600	U08114620	1



by **FACOM**

NF EN ISO 6789 ISO 6789

DIN EN ISO 6789

**811 RB**

**"Non vernier" adjustable click torque wrenches**

- Accuracy  $\pm 4\%$  of the preset torque value
- Reliability of mechanism: 100.000 cycles
- Torque adjustment with a key on a control bench (see torque controllers range)
- Wrenches supplied with ISO 6789 calibration certificate
- The wrenches can be preset and used for tightening and untightening
- To be used with 9x12 or 14x18 mm fittings
- Metal knurled handle
- Numbered wrenches supplied with a protective plastic tube

capacity Nm	lbf.in	capacity lbf.ft
1-5	10-50	-
5-25	45-220	-
10-50	90-440	-
20-100	-	15-74
60-340	-	44-250

capacity Nm	O mm	L mm	code	
1÷5	9x12	200	U08114621	1
5÷25	9x12	250	U08114622	1
10÷50	9x12	331	U08114623	1
20÷100	9x12	399	U08114625	1
60÷340	14x18	618	U08114627	1

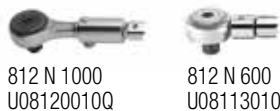

812 N 1000  
U08120010Q

812 N 600  
U08113010

## 812 N

ISO 6789

### Torque wrenches with reversible ratchet

- Adjustable torque model for clockwise and counterclockwise tightening by turning the ratchet 180°
- Accuracy  $\pm 4\%$  of the preset torque value
- Readings in Nm
- Sensible and audible alarm on reaching preset torque value
- Automatic resetting on pressure release after disengagement
- Safety block after setting torque
- Supplied in sheet steel box with test certificate
- Ratchet with male square drive 3/4"

capacity Nm	resolution Nm	L mm	code	
120÷600	2	1050	U08120006	1
200÷1000	4	1490	U08120010	1



## 812 NA

### Spare ratchet

- Reversible ratchet for 812 N 1000
- Can be used with handle 237 3/4"PR

"	mm	code	
3/4	14x18	U08120010Q	1



by FACOM

NF EN ISO 6789

## 812 R

ISO 6789 DIN EN ISO 6789

### High-torque wrenches without accessories

- Accuracy  $\pm 4\%$  of the preset torque value
- Two reading scales: Nm and lbf.ft
- Large size dial
- Light alarm when reaching the preset torque value
- Cylindrical connection: diameter 30 mm
- Numbered wrenches supplied with ISO 6789 calibration certificate

Nm	capacity lbf.ft	resolution Nm
180-900	150-650	25
300-1500	250-1100	50

capacity Nm	L mm	kg	code	
180÷900	595	3,6	U08124601	1
300÷1500	595	4,6	U08124602	1

## 812 RP

by FACOM

### Handle

- Telescopic handle that gives up to 3 m leverage including length of wrench
- To be used with torque wrench U08124603 (500-2.500 Nm)
- Supplied with fasteners

kg	code	
8,2	U08124805	1



by FACOM

NF EN ISO 6789 ISO 6789

DIN EN ISO 6789

## 812 RA

### High-torque wrenches with square drive

- Accuracy  $\pm 4\%$  of the preset torque value
- Two reading scales: Nm and lbf.ft
- Large size dial
- Light alarm when reaching the preset torque value
- Cylindrical connection: diameter 30 mm
- Numbered wrenches supplied with ISO 6789 calibration certificate
- Supplied in metal case 760x220x140 mm

capacity Nm	capacity Lbf.ft	"	L mm
500-2.500	300-1.800	1	724

capacity Nm	L max mm	kg	code	
500÷2500	-	13	U08124703	1



by FACOM

NF EN ISO 6789 ISO 6789

DIN EN ISO 6789

## 812 RB

### High-torque wrenches with ratchet and square drive

- Accuracy  $\pm 4\%$  of the preset torque value
- Two reading scales: Nm and lbf.ft
- Large size dial
- Light alarm when reaching the preset torque value
- Cylindrical connection: diameter 30 mm
- Numbered wrenches supplied with ISO 6789 calibration certificate
- Supplied in metal case 760x220x140 mm

capacity Nm	capacity Lbf.ft	"	L mm
180-900	150-650	3/4	595
300-1.500	250-1.100	3/4	595
500-2.500	300-1.800	1	724

capacity Nm	L mm	kg	code	
180÷900	1019	7,9	U08124801	1
300÷1500	1019	8	U08124802	1
500÷2500	-	18	U08124803	1



by FACOM

ISO 6789

## 813 A

### Electronic torque wrenches

- Accuracy  $\pm 2\%$  of the preset torque value between 20% and 100% wrench capacity
- Measuring mode: peak or follower
- Measuring unit: Nm, lbf.ft, lbf.in and Kg.cm
- To be used with 9x12 or 14x18 mm fittings
- Numbered wrenches supplied with ISO 6789 calibration certificate
- Possibility to preset 9 torque values
- Memory 250 values with PC USB link
- Supplied in plastic case

capacity Nm	"	L mm	code	
1,5÷30	9x12	360	U08134601	1
6,7÷135	9x12	375	U08134602	1
10÷200	14x18	474	U08134604	1



by FACOM

ISO 6789

## 813 B

### Electronic torque wrenches with ratchet

- Accuracy  $\pm 2\%$  of the preset torque value between 20% and 100% wrench capacity
- Measuring mode: peak or follower
- Measuring unit: Nm, lbf.ft, lbf.in and Kg.cm
- To be used with 9x12 or 14x18 mm fittings
- Numbered wrenches supplied with ISO 6789 calibration certificate
- Possibility to preset 9 torque values
- Memory 250 values with PC USB link
- Supplied in plastic case with ratchet

capacity Nm	"	mm	L mm	code	
1,5÷30	1/4	9x12	360	U08134701	1
6,7÷135	3/8	9x12	375	U08134702	1
6,7÷135	1/2	9x12	375	U08134703	1
10÷200	1/2	14x18	474	U08134704	1
17÷340	1/2	14x18	495	U08134705	1



## 814 A

### Torque-angle digital adapter

- Torque and angle tightening with digital precision using conventional tools
- For CW and CCW tightening
- Torque accuracy:  $\pm 4\%$
- Angle accuracy:  $\pm 2\%$
- Measuring mode: peak/track
- Measuring unit: Nm/ft.lb/in.lb/kgcm/degree
- Visible (LED) and audible (BUZZER) indicators when preset target value is reached
- 9 presettable target values
- 50 memory slots for measured values
- Supplied in ABS case with calibration certificates
- Power supply: 2 batteries AAA (included)

capacity Nm	"	resolution Nm	mm	code	
6,8÷135	1/2	0,1 Nm	80	U08140003	1
10÷200	1/2	0,1 Nm	80	U08140004	1
17 ÷340	1/2	0,1 Nm	80	U08140005	1



**824 A**

**ISO 6789**

### Torque screwdrivers

- Adjustable torque model for clockwise tightening, for use in combination with bits from the 660 series or, using an adapter, with sockets from the 1/4" manual series
- Accuracy ± 6% of the preset torque value
- Readings in Nm
- Automatic disengagement on reaching the preset torque value
- Automatic resetting after 120°
- Supplied with regulation key and test certificate

capacity Nm	resolution Nm	L mm	code	
0,5÷2,5	0,1	145	U08240004	1
2÷10	0,5	167	U08240006	1



**824 A/20**

**ISO 6789 DIN EN ISO 6789**

by **FACOM**

### Torque screwdriver for micromechanics

- Adjustable torque model for clockwise tightening, for use in combination with bits 4 mm connection from the FACOM "0" series
- Accuracy ± 6% of the preset torque value
- Readings in Ncm
- Automatic disengagement on reaching the preset torque value
- Automatic resetting after 120°
- Supplied with regulation key and test certificate

capacity Nm	resolution Nm	L mm	g	code	
4÷20	0,05	96,5	75	U08240005	1



**824 A/75**

**ISO 6789**

### Torque screwdriver for micromechanics

- Adjustable torque model for clockwise tightening, for use in combination with bits from the 660 series or, using an adapter, with sockets from the 1/4" manual series
- Accuracy ± 6% of the preset torque value
- Readings in Ncm
- Automatic disengagement on reaching the preset torque value
- Automatic resetting after 120°
- Supplied with regulation key and test certificate

capacity Nm	resolution Nm	L mm	g	code	
15÷75	0,5	135	130	U08240003	1

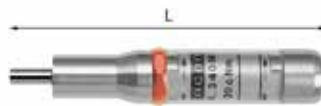

**824 B1**

by **FACOM**

### Production torque screwdrivers with fix torque

- Production torque screwdrivers, ideal when the same tightening values must be repeated
- The desired torque must be pre-set on a control bench
- To be used with the bits with 4 mm connection of series FACOM "0"
- U08240012 to be used in combination with the inserts of the 660 series or, by means of a coupling, with the 1/4" manual sockets
- Accuracy ± 6% of the preset torque value
- Automatic reset on reaching the preset torque value
- Automatic reset after 120°
- Supplied with adjustment key and test certificate

capacity Nm	capacity lbf.in	Ø mm	L mm	g	code	
4÷20	0,35÷1,7	21	96,5	75	U08240011	1
15÷75	1,30÷6,50	23	130	130	U08240012	1



**824 B2**

**ISO 6789 DIN EN ISO 6789**

by **FACOM**

### Production torque screwdrivers with fix torque

- Production torque screwdrivers, ideal when the same tightening values must be repeated
- The desired torque must be pre-set on a control bench
- To be used in conjunction with the 660 series inserts or, with a of connection, to the 1/4" sockets, manual series
- Accuracy ± 6% of the preset torque value
- Automatic reset on reaching the preset torque value
- Automatic reset after 120°
- Supplied with adjustment key and test certificate

capacity Nm	L mm	code	
0,5÷2,5	145	U08240021	1
2÷10	167	U08240022	1



**824 C**

by **FACOM**

### Ratchet handle for torque screwdrivers

- For quick-action use of torque screwdrivers
- Can be used with torque screwdrivers USAG 824 A and 824 B2

g	code	
85	U08240025	1



**824 SK23**

### Universal kit for replacement of cutting plates (23 pcs.)

- Allows to replace the cutting plates used on rotary tools of milling machines
- Contains 2 adjustable torque screwdrivers to optimize torque setting
- Contains all the dimensions of inserts TORX®, TORX PLUS® and hexagonal necessary to replace inserts
- The correct tightening prevents damage to the screw and guarantees longer duration of cutting inserts
- Assortment supplied in ABS box
- Bi-colour foam inside with size marking for quick check of the contents

pcs	description	item/size
4	Bits for hex socket screws - 1/4" / 2-3-4-5	664 EL
8	Bits for TORX PLUS® screws - 1/4" / IP6-IP7-IP8-IP9-IP10-IP15-IP20-IP25	664 IP
8	Bits for TORX® screws - 1/4" / T6-T7-T8-T9-T10-T15-T20-T25	664 TX
1	Magnetic bit-holder adapter - 1/4"	672 AMG
1	Torque screwdrivers	824 A/1,4÷10
1	Torque screwdrivers	824 A/0,5÷2,5
1	Bi-colour foam module (empty)	519 M 824SK23V
1	Empty ABS case - size L	606 L

LxPxH mm	kg	code	
435x270x70	2	U08240007	1



by **FACOM**

**827 A**

**ISO 6789**

### Electronic digital torque controller

- To be used to check the calibration of torque wrenches and screwdrivers
- Large LCD screen with light and audible signals that help reduce the risk of error and allow for clear readability
- Right-handed and left-handed operation
- Reading accuracy +/- 1% clockwise and +/- 3% counterclockwise
- Units of measure: Nm, lbf.ft, lbf.in and Kg.cm
- Measurement modes: trace, peak and first peak
- Possibility to preadjust a limit value and a tolerance shown by a LED indicator (orange, green, red)
- Connection with USB cable
- Supplied with plastic case and calibration certificate

capacity Nm	"	mm	code	
0,5÷5	1/4	-	U08270005	1
5÷50	3/8	-	U08270006	1
35÷350	1/2	-	U08270007	1
100÷1000	-	27	U08270008	1

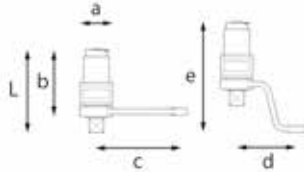

### 828/3000

#### Torque multiplier

- Ratchet model with inversion lever for clockwise and counterclockwise tightening
- Non-return safety system for maintaining multiplier tension, thus avoiding dangerous returns at the end of each tightening operation
- Disengagement device to protect the mechanism which activates when the maximum capacity of the multiplier is exceeded
- Supplied in case with straight and offset safety levers and test certificate
- Dimensions (axbxc): 108x196x310 mm
- Dimensions (dxe): 195x285 mm
- Length (L): 224 mm
- Square female: 1/2"
- Square male: 1"

axbxc mm	dxe mm	L mm	□ "	■ "
108x196x310	195x285	224	1/2	1

capacity Nm	multiplication ratio	transmission ratio	code	
3000	27:1	29,752:1	U08280001	1

### 828/6000

#### Torque multiplier

- Ratchet model with inversion lever for clockwise and counterclockwise tightening
- Non-return safety system for maintaining multiplier tension, thus avoiding dangerous returns at the end of each tightening operation
- Disengagement device to protect the mechanism which activates when the maximum capacity of the multiplier is exceeded
- Supplied with a fabric bag with straight and offset safety levers and test certificate
- Dimensions (axbxc): 119x231x300 mm
- Dimensions (dxe): 213x351 mm
- Length (L): 271 mm
- Square female: 1/2"
- Square male: 1 1/2"

axbxc mm	dxe mm	L mm	□ "	■ "
119x231x300	213x351	271	1/2	1 1/2

capacity Nm	multiplication ratio	transmission ratio	code	
6000	27:1	29,752:1	U08280002	1



### 828 X4

#### Torque multiplier

- Light compact model for use in maintenance of industrial vehicles, agricultural machinery and earth-moving equipment
- Supplied in nylon bag with safety lever and test certificate
- Transmission rate 4:1
- Max input torque: 400 Nm
- Multiplication ratio: 1:3,4
- Square female: 1/2"
- Square male: 3/4"

max input torque Nm	multiplication ratio	□ "	■ "
400	1:3,4	1/2	3/4

capacity max Nm	c mm	L mm	code	
1400	85	600	U08280401	1



### 830

#### Angle torque goniometers

- Model for use in combination with torque wrenches to accomplish tightenings with angle control
- Flexible shaft with anchoring magnet
- Polycarbonate goniometer

□ "	scale	resolution Nm	L mm	code	
1/2	0÷360°	2°	410	U08300001	1
3/4	0÷360°	2°	430	U08300002	1



### 831 A

#### Digital angle meter

- Correct measurement of the angle in any position
- For CW and CCW tightening
- Accuracy: ± 2%
- Range: 0 - 360°
- Resolution: 0,1°
- Visible (LED) and audible (buzzer) indicators when preset target value is reached
- 9 presettable target values
- 50 memory slots for measured values
- Supplied in ABS case with calibration certificates
- Power supply: 2 batteries AAA (included)

scale	resolution	LxPxH mm	code	
0 - 360°	0,1°	68x64x40	U08310001	1



### 870

#### Spring-clips pliers

- For hose clips on cooling, heating, fuel ect.

capacity ø mm	L mm	g gr	code	
12÷60	275	400	U08700003	1



### 870/1

#### Spring-clip pliers

- Long model with blocking system and pivoting tips

capacity ø mm	L mm	g gr	code	
15÷56	275	395	U08700004	1



### 870/2

#### Spring-clip pliers

- Short model with blocking system and pivoting tips

capacity ø mm	L mm	g gr	code	
15÷56	215	340	U08700005	1



### 870 C

#### Pliers for fuel hoses

- For petrol and diesel vehicles
- Ergonomic bimaterial handgrip

L mm	code	
175	U08700006	1



### 871

#### Pliers for CORBIN clamps

- Model with choice of axial or 90° grip that can be locked in three different positions

opening max ø mm	L mm	code	
95	220	U08716001	1





## 871/2

### Pliers for CORBIN clamps

- Model with device for adjustment and blocking of the jaw opening and tips that turn up to 180°

opening max Ø mm	L mm	code	
45	285	U08710002	1



## 871 AN

### Pliers for CORBIN clamps

- For cooling, heating and fuel hoses
- Adjustable arm (600 mm) that keeps the set position
- Rack-type system to reduce efforts

capacity Ø mm	code	
18÷54	U08710005	1



## 871 B

### CLICK spring-clips pliers

- Pivoting jaws to 360° for an easy access

L mm	code	
205	U08710004	1



## 871 C

### CLICK spring-clips pliers

- Three-axial heads to work in any position
- To open and close CLICK spring-clips on fuel circuits, intake manifolds and hydraulic circuits
- Steel body, phosphatized finish
- Ergonomic bimaterial handgrip

L mm	code	
180	U08719005P	1



## 871 D

### Pliers for CORBIN clamps

- Model with frontal or side hooking
- Jaws with serrated gripping surface
- Inside spring
- Ergonomic anti-slip handles

L mm	capacity max Ø mm	code	
206	20	U08710001	1



## 874

### Valve guide seal pliers

- For removing valve guide seals

L mm	code	
235	U08740001	1



## 875

### Socket wrenches for lambda probes

- For installing or removing lambda probes

Ø mm	a mm	L mm	code	
22	30	85	U08750002	1
22L	30	110	U08750012	1



## 876 B

### Pliers to extract the rubber holders on exhaust pipes

- To disassemble and extract the rubber holder for exhaust pipes
- Designed to work safely
- Inside spring
- Ergonomic anti-slip handles

L mm	code	
282	U08760002	1



## 876 N

### Ratchet cutter for exhaust pipes

- Perfect for precise cuts without damages on exhaust pipes mounted on cars
- Ratchet mechanism for quick operations
- Easy access
- Uniform cuts with special cutting rolls and inside roll drive
- Cuts thicknesses up to 3 mm (pipe walls)
- Spare blade DE.8-1

capacity Ø mm	L mm	code	
31÷65	260	U08760001	1



## 877 CE

### Compressed air gas extractor

- For suction and extraction from workshop environment of exhaustion gas coming from cars, industrial vehicles and motorcycles
- Adjustable suction power for cars/trucks
- Model with wheels
- Suction cone with adjustable height (10÷100 cm)
- Complies with the 2001/95/CE and 2003/10/CE norms

characteristics	size
Suction capacity	Car - up to 550 m³/h Truck - up to 790 m³/h
Air consumption	Car - up to 330 l/min Truck - up to 430 l/min
Suction hose length (m)	10
Ø dust hose size (mm)	120

LxPxH mm	kg	code	
500x400x1450	9,5	U08770001	1



## 884 C/S6

### Set of six wrenches for injector pipes fittings

- For assembly and disassembly of injectors pipes fittings
- Bihexagonal openings
- Length: 98 mm
- Square drive 1/2"
- Sizes: 12-14-16-17-18-19 mm
- Special steel
- Chrome plated
- Supplied in plastic box

LxPxH mm	kg	code	
275x160x55	1	U08841000	1



**885 E**

**Remover kit for electrode glow plugs, DIESEL**

- Allows the removal of broken electrodes without disassembling the cylinder head
- Specifica for CITROEN - FORD - MAZDA - PEUGEOT - SUZUKI - TOYOTA - VOLVO engines
- For plugs with M8x1 - M9x1 - M10x1 - M10x1,25 threads
- Supplied in plastic case

gr	code	
900	U08850003	1



**885 F**

**Injector cleaning kit**

- Ideal for duct cleaning of injectors mounted on common rail engines
- Kit consists of:
  - 2 wire brushes Ø 20mm and 25mm for cleaning injectors seat (use only in a clockwise direction)
  - 2 brushes (Aluminum and brass) for cleaning the bottom injectors seats
  - 1 extension for the brushes
  - 2 caps to occlude the combustion chamber connection hole
  - 1 handle to insert and remove the occlusion caps
  - 1 adhesive sandpaper kit Ø 16 mm with supports

LxPxH mm	code	
215x130x55	U08850004	1



**886 K**

**Universal kit for diesel Common rail injector removal**

- To remove injectors
- BOSCH (GM 2.2L included)
- SIEMENS (PIEZO V2 included)
- DELPHI
- Multiple connection system (inside/outside) for injectors BOSCH
- Supplied in plastic case

LxPxH mm	kg	code	
600x420x150	11	U08860010	1



**1/2**

**886 RA**

**Sockets for removal of diesel injector electric connections**

- Hexagonal opening

mm	code	
25	Siemens U08860005Q	1
27	Siemens U08860006Q	1
29	Bosch U08860007Q	1
30	Bosch U08860008Q	1



**886 RB10**

**Hexagonal bit 10 mm for electrode removal**

- Hole Ø 7,5 mm

mm	L mm	code	
10	75	U08860009Q	1



**889 F 230**

**Fluorescent inspection lamp**

- Reinforced structure shock-resistant
- Resistant to products and solvents used in car repair garages and industries (DOT, engine oil, gasoline, diesel ...)
- No overheating during operation
- 2 swivelling and adjustable hooks
- 2 Magnets in the rear side

characteristics	size
Light source	FLUO 11 W
Light flux (lm)	320
Light intensity (lux@0,5m)	470
Lamp protection level	IP55
Supply voltage (V)	230
Cable length (m)	10
Cable type	H05 RN-F
Operating temperature (°C)	-20 ÷ 40

LxPxH mm	gr	code	
380x56x44	450	U08890007	1



**NEW**



**889 GR**

**LED compact spotlight**

- Ideal for illuminating wide working areas
- Super compact
- Body in composite material
- Impact resistant
- Equipped with motion detection sensor: once lamp is turned on, it will be possible to activate the sensor by pressing the button with "hand" logo. If no movements around, after about 20 seconds the lamp will turn off, and activating again whenever a movement will be detected (up to 5 meters away)
- Fluorescent reflector to locate the unlit spotlight in very dark areas
- 3 selectable brightness levels
- High resistance reinforced structure
- Magnetic base adjustable in several positions up to 90°
- Mountable on tripod
- Check of charge status with warning light on lamp body (red: charging in progress, green: charge complete)
- Supplied with USB-C cable



characteristics	size
Light source	18 x 0.5W SMD LED
N° lighting modes	3
Light intensity (lux@0,5m)	80-360-720
Light flux (lm)	50-250-500
Light beam distance (m)	8-18-25
Beam angle	120° ±20%
Color Rendering Index (CRI)	80
Protection level	IP54
Shock resistance	IK07
Battery type (supplied)	3.7V Li-ion 2600mAh
Autonomy min-max (hours)	18-3,6-1,8
Recharge time (hours)	2,5
Operating temperature (°C)	0-40
Battery charger (INPUT)	AC 100-240V 50/60HZ 0.2A
Battery charger (OUTPUT)	DC 5.0V 1A

LxPxH mm	gr	code	
91x55x47	286	U08890044	1



NEW



## 889 IL CE

### Articulated LED inspection lamp

- Ideal for illuminating narrow points with limited access
- Body in composite material (black part aluminum - red part polypropylene)
- The torch function is activated by holding down the power button for 2 seconds
- 3 lighting modes: head, front, flashlight
- 4-LED battery level indicator (LEDs flash while charging)
- Jointed and 180° adjustable
- Magnet at the end of the headlamp, to retrieve small metal parts
- Magnetic base and hook clamp
- Supplied with USB-C cable



#### characteristics

characteristics	size
Light source (lamp function)	1 x COB LED (3.1 W)
Light source (head)	1 x SMD LED (1.8 W)
Light source (torch function)	1 x SMD LED (0.5 W)
Light intensity lamp (lux@0,5m)	420
Light intensity head (lux@0,5m)	2300
Light intensity torch (lux@0,5m)	50
Light flux lamp (lm)	400
Light flux head (lm)	50
Light flux torch (lm)	150
Color Rendering Index lamp (CRI)	80
Color Rendering Index head (CRI)	80
Color Rendering Index torch (CRI)	70
Beam angle lamp	120° ±20%
Beam angle head	120° ±20%
Beam angle torch	40° ±20%
Protection level	IP20
Shock resistance	IK07
Battery type (supplied)	3,7V Li-ion 2600mAh
Autonomy head (hours)	35
Autonomy lamp (hours)	3
Autonomy torch (hours)	10
Recharge time (hours)	4
Working temperature (°C)	AC 100-240V 50/60HZ 0,2A
Battery charger (OUTPUT)	DC 5.0V 1A

L max mm	L min mm	P mm	code	
275	160	40	U08890046	1



## 889 KB CE

### Cable reel with inspection lamp

- Model with automatic cable rewind with roller guide
- Cable stop can be inserted every 50 cm
- Shock resistant body with swivelling bracket for attachment to wall
- Polypropylene structure with bimaterial handle
- Cable sheathed in neoprene
- Supplied without bulb

#### characteristics

characteristics	size
Light source	FLUO E27
Power max (W)	15
Lamp protection level	IP65
Cable reel protection level	IP42
Cable length (m)	15
Cable type	H05 RN-F
Supply voltage (V)	230

LxPxH mm	kg	code	
375x290x175	4,0	U08890005	1



## 889 LTE CE

### Frontal LED lamp

- Motion sensor to switch the lamp on and off without touching it
- Two brightness levels selectable
- High resistance plastic body
- Edge bumper
- Can also be used with protective helmets
- Adjustable
- Removable, adjustable elastic band

#### characteristics

characteristics	size
Light source	1 x COB LED
N° lighting modes	2
Light flux (lm)	50-200
Light beam distance (m)	45-90
Protection level	IP54
Shock resistance	IK05
Battery type (supplied)	3 x 1,5V AAA
Autonomy min-max (hours)	24-6,5
Working temperature (°C)	-20 ÷ +70

kg	code	
100	U08890014	1



## 889 RA CE

### LED pocket pen lamp

- Hanging clip
- Magnetic base
- Optional strap with additional magnet
- Switch button
- Shock resistant plastic body

#### characteristics

characteristics	size
Light source	1 x LED
Light intensity (lux@0,5m)	100
Light flux (lm)	36
Protection level	IP54
Battery type (supplied)	3 x 1,5V AAA
Autonomy (hours)	11

L mm	kg	code	
120	115	U08890031	1



## 889 RF CE

### LED flexible lamp

- Ideal for illuminating points with limited access
- Aluminum head with adjustable focus
- Flexible extension
- Magnetic base
- The lamp works with standard batteries or with battery charger 889 UC (not supplied)
- Flexible extension: length: 21 cm
- Total length: 41 cm
- Lamp diameter: 34,5 mm

#### characteristics

characteristics	size
Light source	1 x LED 3W
Light intensity (lux@0,5m)	1551
Light flux (lm)	250
Protection level	IP54
Shock resistance	IK07
Battery type (not supplied)	2 x 1,5V AAA
Autonomy (hours)	15
Operating temperature (°C)	-20 ÷ +40

kg	code	
370	U08890040	1



NEW



### 889 RL CE

#### LED inspection lamp

- Dual use: inspection lamp or torch
- Magnetic base adjustable up to 180°
- Two rear magnets
- Two retractable hooks that can be rotated 360°
- Check of charge status with warning light on lamp body (red: charging in progress, green: charge complete)
- Mountable on tripod
- Supplied with USB-C cable

characteristics	size
Light source (lamp function)	1 x COB LED (4 W)
Light source (torch function)	1 x SMD LED (0,7 W)
Light intensity lamp (lux@0,5m)	80-280
Light intensity torch (lux@0,5m)	800
Light flux lamp (lm)	120-420
Light flux torch (lm)	50
Color Rendering Index (CRI)	80
Light beam distance lamp (m)	15-30
Light beam distance torch (m)	50
Beam angle lamp	120° ±20%
Beam angle torch	20° ±20%
Protection level	IP43
Shock resistance	IK07
Battery type (supplied)	3.7 V Li-Ion 4400 mAh
Autonomy: lamp function (hours)	3(1° step)-10(boost)
Autonomy: torch function (hours)	25
Recharge time (hours)	4,5
Working temperature (°C)	-20 ÷ +40
Caricabatterie (INPUT)	AC 100-240V 50/60HZ 0.2A
Caricabatterie (OUTPUT)	DC 5.0V 1A

LxPxH mm	g	code	
215x27	291	U08890036	1



### 889 RP CE

#### Compact LED rechargeable inspection lamp

- Dual use: inspection lamp or torch
- Magnetic base adjustable up to 180°
- Retractable hook that can be rotated 360°
- Belt hook
- Check of charge status with warning light on lamp body (red: charging in progress, green: charge complete)
- Supplied with wall type charger with USB output

characteristics	size
Light source (lamp function)	1 x 2,5 W COB LED
Light source (torch function)	3 x SMD LED
Light flux: lamp-torch (lm)	180-60
Light intensity (lux@0,5m)	220-90
Beam angle	120°
Light beam distance: lamp-torch (m)	5-10
Color temperature (k)	6500
Color Rendering Index (CRI)	80
Protection level	IP20
Battery type (supplied)	3.7V Li-Ion 1800 mAh
Autonomy min-max (hours)	3-10
Recharge time (hours)	4,5
Operating temperature (°C)	-20 ÷ +50
Battery charger (INPUT)	AC 100-240V 50/60HZ
Battery charger (OUTPUT)	DC 5V 1000 mA

LxPxH mm	g	code	
131x31x62	140	U08890045	1



### 889 RT CE

#### Rechargeable LED spotlight - certified IP67

- Ideal for illuminating wide working areas
- Can be used both indoor and outdoor
- Resistant to water, dust and chemicals
- Shock resistant
- Double mode operation: with or without cable
- Up to 8 hours of use in cordless mode
- 3 selectable brightness levels
- High resistance reinforced structure
- Magnetic base adjustable up to 180°
- Can be mounted on the tripod
- Supplied with 5 m charger cable, with warning light (red: charging in progress, green: charge complete)
- Spare battery charger: code 1004732-64

characteristics	size
Type and number of LED	1 x 10.6W COB LED
N° lighting modes	3
Light intensity (lux@0,5m)	690-1390-2030
Light flux (lm)	500-1000-1500
Light beam distance (m)	26-37-45
Beam angle	120°
Color Rendering Index (CRI)	85
Protection level	IP67
Shock resistance	IK07
Battery type (supplied)	11. V Li-Ion 2600 mAh
Autonomy min-max (hours)	2,5-4-8
Recharge time (hours)	2,5
Operating temperature (°C)	-10 ÷ +40
Battery charger (INPUT)	AC 100-240V 50/60HZ 0.5A
Battery charger (OUTPUT)	DC 12.6V 1.3A

LxPxH mm	Kg	code	
160x63x130	2	U08890038	1



### 889 TS CE

#### Pen-type LED torch in Aluminium - 110 Lumen

- Anodised Aluminium body
- Built-in front glass
- 3 lighting modes: high-medium-strobe
- Hanging clip
- Switch on with back button

characteristics	size
Light source	1 x SMD LED
N° lighting modes	3
Light flux (lm)	110-50-Strobe
Color temperature (k)	6500
Light beam distance (m)	50
Protection level	IP54
Battery type (not supplied)	2 x AAA
Autonomy min-max (hours)	1,5-3
Working temperature (°C)	-20 ÷ +50

LxPxH mm	g	code	
140x15x15	54	U08890070	1



### 889 TM CE

#### Pen-type LED torch in Aluminium - 170 Lumen

- Anodised Aluminium body
- Built-in front glass
- 3 lighting modes: high-medium-strobe
- Hanging clip
- Switch on with back button

characteristics	size
Light source	1 x SMD LED
N° lighting modes	3
Light flux (lm)	170-55-Strobe
Color temperature (k)	6500
Light beam distance (m)	80
Protection level	IP54
Battery type (not supplied)	2 x AA
Autonomy min-max (hours)	1,5-3
Working temperature (°C)	-20 ÷ +50

LxPxH mm	g	code	
152x24x24	64	U08890071	1



### 889 TL CE

#### LED torch in Aluminium - 680 Lumen

- Anodised Aluminium body
- Built-in front glass
- 3 lighting modes: high-medium-strobe
- Adjustable zoom function
- Switch on with back button

characteristics	size
Light source	1 x SMD LED
N° lighting modes	3
Light flux (lm)	680-190-Strobe
Color temperature (k)	7500
Light beam distance (m)	250
Protection level	IP54
Battery type (not supplied)	3 x C
Autonomy min-max (hours)	6-15
Working temperature (°C)	-20 ÷ +50

LxPxH mm	g	code	
213x40x31	210	U08890072	1



### 889 TR CE

#### Rechargeable LED torch in Aluminium - 600 Lumen

- Anodised Aluminium body
- Built-in front glass
- 3 lighting modes: high-medium-strobe
- Switch on with back button
- Check of charge status with warning light on lamp body (red: charging in progress, green: charge complete)
- Supplied with USB cable

characteristics	size
Light source	1 x SMD LED
N° lighting modes	3
Light flux (lm)	600-200-Strobe
Color temperature (k)	6500
Light beam distance (m)	250
Protection level	IP54
Battery type (supplied)	3,7V Li-Ion 2200 mAh
Autonomy min-max (hours)	2-5
Recharge time (hours)	6
Working temperature (°C)	-20 ÷ +50

LxPxH mm	g	code	
156x40x26	170	U08890073	1



## 889 TRQ

### Spare battery

- For lamp 889 TR

code

U08890073Q 1



NEW



## 889 TRE

### Rechargeable LED torch - dual use

- Dual use: inspection lamp or torch
- Resistant to water and dust
- Hanging clip
- Check of charge status with warning light on lamp body (red: charging in progress, green: charge complete)
- Supplied with wall type charger with USB output

characteristics	size
Light source (lamp function)	1 x 1.3W COB LED
Light source (torch function)	1 x 1.3W SMD LED
Light intensity lamp (lux@0,5m)	120-240
Light intensity torch (lux@0,5m)	3300
Light flux lamp (lm)	75-150
Light flux torch (lm)	125
Color Rendering Index (CRI)	80
Light beam distance lamp (m)	10-15
Light beam distance torch (m)	55
Beam angle lamp	100°
Beam angle torch	20°
Protection level	IP67
Shock resistance	IK06
Battery type (supplied)	3.7V Li-poly 750 mAh
Autonomy lamp (hours)	2-4
Autonomy torch (hours)	2
Recharge time (hours)	3,5
Working temperature (°C)	-10 ÷ +40
Battery charger (INPUT)	100-240V 50/60Hz 0.2A MAX
Battery charger (OUTPUT)	DC 5.0V 1.0A 5W

L mm	g	code	
180	85	U08890018	1



## 889 UB

### Rechargeable under bonnet LED inspection lamp

- Ideal to illuminate the engine compartment and the passenger compartment of a car or a commercial vehicle
- Aluminium frame with rubber coated self-locking hooks
- ABS handle
- Supplied with cigarette lighter and battery charger with light (red: charging, green: charge complete)

characteristics	size
Extension: min-max (mm)	1270÷2100
Light source	88 x SMD LED
Light intensity (lux@0,5m)	700
Light flux (lm)	800
Beam angle	120°
Protection level	IP44
Shock resistance	IK07
Battery type (supplied)	7.4 V Li-Ion 2600 mAh
Autonomy (hours)	3/4
Recharge time (hours)	4/5
Operating temperature (°C)	-20 ÷ +50
Battery charger (INPUT)	AC100-240V 50/60 Hz 1.0A Max
Battery charger (OUTPUT)	8.4V 1A

LxPxH mm	kg	code	
1270x90x175	2	U08890034	1



## 889 UC

### Spare charger 230 V

- For lamps 889 RD, 889 RF, 889 RUV and 889 UB
- Can be used also with lamp 889 RC (models up to 2016)

code

U08890032Q 1



## 890

### Battery tester

- For measuring battery charge (6 and 12 V), with turned-off engine, with results within 5 sec
- Allows to check the functioning of the alternator

g	code	
540	U08900001	1



## 890 K

### Digital battery tester with printer

- Measures the state of charge, the capacity and efficiency of the batteries from 6 to 12V, also with "Start & Stop" system
- Checks the alternator efficiency and the starting system from 12V to 24V
- It allows you to test batteries: EFB, flat AGM, SPIRAL AGM, VRLA / GEL, standard Liquid
- LCD screen
- Thermal printer (no ink required)
- 6 languages selectable
- Cables length: 2 m
- Supplied in a plastic case with shock-resistant shell and 2 rolls of paper
- Spare cables: code BAT.TEST-C

characteristics	size
Battery diagnosis (V)	6-12
Charge system (V)	12-24
Start and Stop Battery capacity (Ah)	SAE (CCA): 40÷2000 A, EN: 40÷2100 A, DIN: 25÷1300 A, IEC: 30÷1500 A
Battery capacity (Ah)	SAE (CCA): 40÷3000 A, EN: 40÷2830 A, DIN: 25÷1685 A, IEC: 30÷1985 A
Display	LCD
Battery type (supplied)	4 x AA

LxPxH mm	code	
305x90x205	U08901000	1



## 890 KA

### Paper rolls

- Paper rolls for 890 K (2 pieces)

code   
U08910100Q 1



**892 D**

**Battery fillers**

- Made of plastic: acid-resistant, oil-resistant and solvent-resistant



capacity ml	code	
500	U08920005	1
1000	U08920006	1



**892 E**

**Suction pump for battery liquid**



L mm	code	
280	U08920007	1



**899 N**

**Stethoscope**

- To locate engine defects  
- Plastic grip



shaft mm	code	
230	U08990000	1



**905 A**

**Antifreeze hydrometer**

- Measures antifreeze levels in engine coolant  
- Two scales: for cold or warm engines



L mm	code	
280	U09050003	1



**905 BN**

**Acyd hydrometer for batteries**

- Measures the density of the battery liquid



L mm	code	
230	U09050005	1



**906 N**

**Pump for checking and calibrating diesel engine injectors**

- To check the correct working of injectors and atomization pressure  
- Tank with filter  
- Supplied with connectors 906 NA and 906 NB  
- Fitting for M14 connectors



bar	code	
0÷600	U09060004	1



**906 NA**

**Connection pipe (for Bosch injectors)**



description	code	
M12 x M14	U09060003Q	1



**906 NB**

**Connection pipe (for Bosch injectors)**



description	code	
M14 x M14	U09060004Q	1



**907 N**

**Digital timing light**

- For the stroboscopic visualization of the spark lead marks  
- Suitable for 2 or 4 stroke engines until 2 sparks/rpm  
- Reading memory  
- Supplied in plastic box with cables and crocodile clips



characteristics	size
RPM	400÷19.999
Timing advance	0÷78°/90° (400/465)
DWELL	0÷65 ms 0÷100% 0÷120° (> 600 rpm/min)
Direct and peak voltage (V)	1÷70
Timing revolutions counter	60÷600
Power supply (V)	9,5÷15

kg	code	
1,7	U09070080	1



**907 S**

**Timing light**

- For the stroboscopic visualization of the spark lead marks  
- Suitable for 2 or 4 stroke engines until 2 sparks/rpm  
- Supplied in plastic box with cables and crocodile clips



kg	code	
1,4	U09070082	1



**1**  
**910 E1 1" ■ CE**

**Aluminium impact wrench**

- Reversible model with double hammer mechanism
- Four power settings for thightening and untightening
- Spare rotor blades (6 pieces): code 31K100061

characteristics	size
Square drive (")	1
Bolt capacity	M33
Max torque (Nm)	4068
Torque range (Nm)	850÷1300
Strokes per minute	720
Free speed (rpm)	4500
Average air consumption (l/min)	243
Recommended air pressure (bar)	6,2
Sound level dB(A)	102 ±3
Sound power dB(A)	113 ±3
Vibrations (m/s <sup>2</sup> )	15,20
Air inlet (")	1/2
Ø hose size (mm)	13

LxPxH mm	kg	code	
300x205x290	10,3	U09100020	1

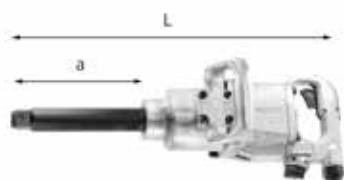

**1**  
**910 EL1 1" ■ CE**

by **ERACOM**

**Aluminium impact wrench**

- Reversible model with double hammer mechanism
- Three power settings for thightening and untightening
- Spare rotor blades (6 pieces): code 31K100048

characteristics	size
Square drive (")	1
Bolt capacity	M33
Max torque (Nm)	4068
Torque in use (Nm min-Max)	850÷1300
Strokes per minute	720
Free speed (rpm)	4400
Average air consumption (l/min)	243
Recommended air pressure (bar)	6,2
Sound level dB(A)	103 ±3
Sound power dB(A)	114 ±3
Vibrations (m/s <sup>2</sup> )	16,70
Air inlet (")	1/2
Ø hose size (mm)	13

LxPxH mm	a mm	kg	code	
523x202x172	170	11,3	U09100023	1



**1/2**  
**913 PC2 1/2" ■ CE**

**Impact ratchet**

- Ultra-compact reversible model with rear air exhaust
- Outside body in high-resistant composite material and steel front housing
- Spare rotor blades: code 31K100142

characteristics	size
Square drive (")	1/2
Bolt capacity	M10
Max torque (Nm)	136
Free speed (rpm)	280
Average air consumption (l/min)	113
Recommended air pressure (bar)	6,2
Sound level dB(A)	99 ±3
Sound power dB(A)	110 ±3
Vibrations (m/s <sup>2</sup> )	9,1
Air inlet (")	1/4
Ø hose size (mm)	10

LxPxH mm	kg	code	
260x43x52	1,2	U09130017	1



**916 B2 ■ CE**

**Air drill (10 mm)**

- Non-reversible pistol-grip model with self-locking chuck, air exhaust through the handle and variable-speed trigger regulator
- Spare rotor blades (4 pieces): code V.103MFAV17

characteristics	size
Power (Kw)	0,45
Free speed (rpm)	2800
Average air consumption (l/min)	124
Recommended air pressure (bar)	6,2
Sound level dB(A)	87,4 ±3
Sound power dB(A)	98,4 ±3
Vibrations (m/s <sup>2</sup> )	7,20
Air inlet (")	1/4
Ø hose size (mm)	10

LxPxH mm	kg	code	
234x44x145	1,45	U09160012	1



**918 B ■ CE**

**Hammer with hexagonal attachment**

- Model with adjustable speed and variable-spend trigger, with connection for chisels with hexagonal shank 918 BH

characteristics	size
Ø shank (mm)	10
Strokes per minute	3000
Piston stroke (mm)	67
Average air consumption (l/min)	90
Recommended air pressure (bar)	6,2
Sound level dB(A)	102,6 ±3
Sound power dB(A)	113 ±3
Vibrations (m/s <sup>2</sup> )	8,01
Air inlet (")	1/4
Ø hose size (mm)	10

LxPxH mm	kg	code	
171x50x160	1,6	U09180006	1



**918 M1**

**Spare spring (for 918 B)**

kg	code	
55	U09180020Q	2



**920 AN1 ■ CE**

**Roto-orbital sander (orbit 5 mm)**

- Model with adjustable speed and power regulator for intermediate sanding and finishing
- Supplied with pad for Velcro disks 920 AH1
- Spare rotor blades (6 pieces): code V.252FSAV32B

characteristics	size
Power (Kw)	0,19
Ø Pad capacity	152
Orbit (mm)	5
Free speed	10000
Average air consumption (l/min)	105
Recommended air pressure (bar)	6,2
Sound level dB(A)	78,9 ±3
Sound power dB(A)	79,9 ±3
Vibrations (m/s <sup>2</sup> )	11,8
Air inlet (")	1/4
Ø hose size (mm)	10

LxPxH mm	kg	code	
221x152x106	800	U09200011	1



NEW

## 920 A1

### Pads with 6 holes for Velcro disks

- For sander 920 AN1

n°	Ø mm	code	
1	152	U09200012Q	1



## 921 A CE

### Angle grinders

- Model with adjustable speed and power regulator
- Front air exhaust
- Removable side handle
- Adjustable protection carter
- Spare rotor blades (4 pieces): code V.462FSAV25

characteristics	size
Disk diameter (mm)	100 (125)
Ø disk connection (mm)	16 (24)
Power (Kw)	0,75
Free speed (rpm)	12000
Average air consumption (l/min)	120
Air inlet (")	1/4
Ø hose size (mm)	10
Recommended air pressure (bar)	6,2
Sound level (free/working) (dB(A))	86 / 94
Vibrations (m/s <sup>2</sup> )	2,5

n°	L mm	kg	code	
4 (Ø 125mm)	220	1,9	U09210012	1



## 921 B1 CE

### Straight die grinder - 0,4 CV (300W)

- It can be used for drilling, weld breaking, smoothing the sharp edges as well as for deburring, polishing, grinding, grooving, removing material, sanding etc
- Snap safety lever
- Supplied with 6 mm collet
- Front air exhaust
- Spare rotor blades (4 pieces): code V.345FSAV14
- Spare collet 6 mm: code V.345FSAV03

characteristics	size
Free speed (rpm)	20000
Power (CV-W)	0,4-300
Collet size (mm)	6
Average air consumption (l/min)	113
Recommended air pressure (bar)	6,2
Sound level dB(A)	93,3 ±3
Sound power dB(A)	104,3 ±3
Vibrations (m/s <sup>2</sup> )	2,5
Air inlet (")	1/4
Ø hose size (mm)	10

LxPxH mm	kg	code	
142x40x62	600	U09210015	1



## 922 B1 CE

### Straight grinder - 0.3 CV (220 W)

- It can be used for drilling, weld breaking, smoothing the sharp edges as well as for deburring, polishing, grinding, grooving, removing material, sanding etc
- Double bearing system inside to ensure longer service life
- Body and handle in resistant anti-slip material insulated against cold and vibrations
- Adjustable speed
- Snap safety lever
- Supplied with 6 mm collet
- Rear air exhaust
- Spare rotor blades (4 pieces): code N444798
- Spare collet 6 mm: code N444782

characteristics	size
Free speed (rpm)	30000
Power (CV-W)	0,3-220
Collet size (mm)	6
Average air consumption (l/min)	76
Recommended air pressure (bar)	6,2
Sound level dB(A)	84,8 ±3
Sound power dB(A)	99,5 ±3
Vibrations (m/s <sup>2</sup> )	2,42
Air inlet (")	1/4
Ø hose size (mm)	10

LxPxH mm	kg	code	
160x39x70	440	U09220001	1



## 922 B2 CE

### Straight grinder - 0.5 CV (368 W)

- Powerful 0,5 CV motor for high productivity
- It can be used for drilling, weld breaking, smoothing the sharp edges as well as for deburring, polishing, grinding, grooving, removing material, sanding etc
- Double internal bearing system to ensure a longer tool life
- Body and handle in resistant anti-slip material insulated against cold and vibrations
- Adjustable speed
- Snap safety lever
- Supplied with 6 mm collet
- Rear air exhaust
- Spare rotor blades (4 pieces): code N444850
- Spare collet 6 mm: code N444782

characteristics	size
Free speed (rpm)	25000
Power (CV-W)	0,5-368
Collet size (mm)	6
Average air consumption (l/min)	113
Recommended air pressure (bar)	6,2
Sound level dB(A)	85,4 ±3
Sound power dB(A)	99,8 ±3
Air inlet (")	1/4
Ø hose size (mm)	10
Vibrations (m/s <sup>2</sup> )	1,86

LxPxH mm	kg	code	
177x48x77	675	U09220002	1



## 922 BL1 CE

### Long anvil straight grinder - 0.3 CV (220 W)

- Model with extended shaft, length 126 mm
- For working in confined spaces inside castings, for removing cracks and weldings in the corners
- Double internal bearing system to ensure a longer tool life
- Body and handle in resistant anti-slip material insulated against cold and vibrations
- Adjustable speed
- Snap safety lever
- Supplied with 6 mm collet
- Rear air exhaust
- Spare rotor blades (4 pieces): code N444798
- Spare collet 6 mm: code N444782

characteristics	size
Free speed (rpm)	28000
Power (CV-W)	0,3-220
Collet size (mm)	6
Average air consumption (l/min)	76
Recommended air pressure (bar)	6,2
Sound level dB(A)	83,3 ±3
Sound power dB(A)	94,3 ±3
Air inlet (")	1/4
Vibrations (m/s <sup>2</sup> )	2,86
Ø hose size (mm)	10

LxPxH mm	kg	code	
255x39x70	664	U09220003	1

## RANGE OF GRINDERS 922

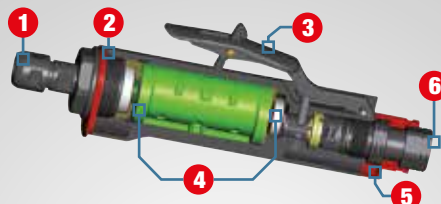

1. Collet size 6 mm.
2. Body and handle in anti-slip material.
3. Safety snap lever.
4. Double bearing system for longer life.
5. Rear air exhaust.
6. 1/4" threaded connection".

## WATCH THE VIDEO

Go to our YouTube channel or frame the QR Code



YouTube





## 922 BP1 CE

### 90° Angle grinder - 0.3 CV (220 W)

- Model with head angled at 90°
- It can be used for removing weld lines and burrs, for grinding welded areas, of sanding, deburring, finishing, cutting, etc.
- Double internal bearing system to ensure a longer tool life
- Body and handle in resistant antislip material insulated against cold and vibrations
- Adjustable speed
- Snap safety lever
- Supplied with 6 mm collet
- Rear air exhaust
- Spare rotor blades (4 pieces): code N444798
- Spare collet 6 mm: code N444782

characteristics	size
Free speed (rpm)	23000
Power (CV-W)	0,3-220
Collet size (mm)	6
Average air consumption (l/min)	76
Recommended air pressure (bar)	6,2
Sound level dB(A)	85,9 ±3
Sound power dB(A)	96,9 ±3
Vibrations (m/s <sup>2</sup> )	4,54
Air inlet (")	1/4
Ø hose size (mm)	10

LxPxH mm	♠ gr	code	
165x27x75	555	U09220004	1



## 923 A CE

by **FRACOM**

### Reciprocating saw

- Model with adjustable speed, for use with blades 923 AH/1-2

characteristics	size
Strokes/minute	10000
Average air consumption (l/min)	230
Air inlet (")	1/4
Recommended air pressure (bar)	6,2
Sound level dB(A)	83,5 ±3
Sound power dB(A)	94,5 ±3
Vibrations (m/s <sup>2</sup> )	17,1
Ø hose size (mm)	10

LxPxH mm	♠ gr	code	
270x40x40	800	U09230002	1



## 923 AH

### Blades (for 923 A)

- High Speed Steel
- For sheet steel cutting (923 AH1), light alloy/plastic/wood (923 AH2)

n°	teeth/inch	L mm	code	
1	32	90	U09230001Q	5
2	24	90	U09230002Q	5



## 925 A

### Silicone gun

- Model with device to stop the flow of material
- Aluminium body

L mm	code	
340	U09250002	1



## 927 MN CE

### Blow gun with gauge

- Model with double valve, Aluminium body and graduated scale in bar/psi
- Complies with CEE 86/217 standard

characteristics	size
Scale	0÷10 bar/0÷140 psi
Inner head Ø (mm)	6
Air inlet (")	1/4

L mm	hose mm	code	
197	440	U09270003	1



## 926 A CE

### Oleo-pneumatic riveter

- Supplied with four interchangeable nozzles and service key

characteristics	size
Capacity Ø (Al/inox) (mm)	2,4÷4,8
Stroke (mm)	14
Average air consumption (l/min)	113
Recommended air pressure (bar)	6,2
Vibrations (m/s <sup>2</sup> )	1,3
Air inlet (")	1/4
Ø hose size (mm)	10

L mm	♠ gr	code	
230	1,6	U09260001	1



## 927 B

### Progressive blow gun in shockproof plastic material

- Connection thread made in the plastic body
- Stainless steel tube
- The shape of the gun has been designed to allow a particularly comfortable use of the operating lever
- The dispensing device requires only 7 N of effort

characteristics	size
Average air consumption at 6 bar (l/min)	460
Air inlet (brass) (")	1/4
Sound level at 6 bar (dB(A))	≤ 85
Working temperature (°C)	-10 ÷ +40

L mm	L1 mm	♠ gr	code	
246	108	110	U09270006	1



1/2



## 928 AC1 1/2 CE

### Aluminium impact wrench

- Steel front casing
- Aluminum motor housing
- Reversible model with double hammer mechanism
- 7 torque settings, in both directions of rotation
- Progressive trigger
- Soft-touch bi-material handle
- Silencer and air exhaust integrated in the handle
- Spare rotor blades (6 pieces): code N573357

characteristics	size
Square drive (")	1/2
Bolt capacity	M16
Max torque (Nm)	1490
Torque in use (Nm min-Max)	135÷380
Strokes per minute	1120
Free speed (rpm)	6500
Average air consumption (l/min)	147
Recommended air pressure (bar)	6,2
Sound level dB(A)	90 ±3
Sound power dB(A)	101 ±3
Vibrations (m/s <sup>2</sup> )	5,2
Air inlet (")	1/4
Ø internal hose (mm)	10

LxPxH mm	♠ Kg	code	
190x70x193	2,8	U09280014	1



3/4

### 928 D1 3/4" ■ CE

#### Aluminium impact wrench

- Reversible model with double hammer mechanism
- Six power settings for tightening and untightening
- Spare rotor blades (6 pieces): code 31K100021

characteristics	size
Square drive (")	3/4
Bolt capacity	M24
Max torque (Nm)	1700
Torque in use (Nm min-Max)	500÷1050
Strokes per minute	790
Free speed (rpm)	5700
Average air consumption (l/min)	193
Recommended air pressure (bar)	6,2
Sound level dB(A)	98,4 ±3
Sound power dB(A)	109,4 ±3
Vibrations (m/s <sup>2</sup> )	9,1
Air inlet (")	3/8
Ø hose size (mm)	13

LxPxH mm	kg	code	
222x93x233	5,6	U09280015	1



3/4

### 928 PD1 3/4" ■ CE

#### Impact wrench (composite material frame)

- Reversible model with double hammer, air exhaust through the handle, power regulator
- Ultra-light casing in high-resistant composite material and steel front housing
- Spare rotor blades (6 pieces): code 31K100037

characteristics	size
Square drive (")	3/4
Bolt capacity	M27
Max torque (Nm)	1950
Torque in use (Nm min-Max)	200÷750
Strokes per minute	850
Free speed (rpm)	6360
Average air consumption (l/min)	125
Recommended air pressure (bar)	6,2
Sound level dB(A)	99,1 ±3
Sound power dB(A)	110,1 ±3
Vibrations (m/s <sup>2</sup> )	10,7
Air inlet (")	3/8
Ø hose size (mm)	13

LxPxH mm	kg	code	
221x86x213	3,9	U09280065	1



1/2

### 929 PC1/C12 ●

#### Assortment with hexagonal sockets and impact wrench in modular box (12 pcs.)

- Plastic box
- Ergonomic integrated handle
- Double metal closing clip
- Empty sheet steel box: code U09290005Q

pcs	description	item/size
10	Impact hexagonal sockets / 10-13-17-18-19-22-24-27-30-32	235 1/2 M
2	Lock pins	235 MCA/4-6
2	Safety rings	235 MDA/4-6
1	Impact extensions	236 1/2 M/125
1	Magnesium impact wrench	929 PC1 1/2

LxPxH mm	code	
415x283x92	U09290005	1



3/4

### 928 DN/S12 ●

#### Assortment with impact wrench in sheet steel case (13 pcs.)

- Closing clip and carrying handle
- The inside tray is studied to be stored in USAG roller cabinet drawers
- Empty bi-colour foam module: code U05191000Q
- Empty sheet steel box: code U06120005Q

pcs	description	item/size
8	Impact hexagonal sockets / 17-19-22-24-27-30-32-36	235 3/4 M
1	Lock pins	235 MCA/8
1	Safety rings	235 MDA/8
2	Impact extensions/100-250	236 3/4 M
1	Sheet steel box (empty) - size XXL	612 XXL
1	Aluminium impact wrench	928 D1 3/4
1	Bi-colour foam module (empty)	519 M 928SV

LxPxH mm	kg	code	
575x435x217	16,5	U09280016	1



1/2

### 929 PC1 1/2" ■ CE

#### Magnesium impact wrench

- Magnesium alloy casing: lightweight and powerful
- Aluminum motor housing
- Reversible model with double hammer mechanism
- 3 tightening torque settings, always maximum untightening power
- Inversion and adjustment by Aluminium lever
- Progressive trigger
- Rubber side bumpers
- Balanced weight for maximum comfort
- Soft-touch bi-material handle
- Silencer and air exhaust integrated in the handle
- Spare rotor blades (8 pieces): code 1004755-67

characteristics	size
Square drive (")	1/2
Bolt capacity	M16
Max torque (Nm)	1600
Torque in use (Nm min-Max)	280÷440
Strokes per minute	1300
Free speed (rpm)	7000
Average air consumption (l/min)	172
Recommended air pressure (bar)	6,2
Sound level dB(A)	93 ±3
Sound power dB(A)	104 ±3 dB(A)
Vibrations (m/s <sup>2</sup> )	6,2
Air inlet (")	1/4
Ø internal hose (mm)	10

LxPxH mm	kg	code	
162x75x212	2	U09290001	1



### 930 G

#### Lubricating oil for airtools

- For lubrication line or directly on the airtool

characteristics	size
Density to 20° (Kg/m <sup>3</sup> )	877
Viscosity to 40°C	65
Viscosity to 100°C (cSt)	8,7
Viscosity index	110
Freezing point (°C)	-23

ml	code	
500	U09300032	1



### 934 B

#### Male threaded universal quick couplers with balls

- Brass body, Nickel plated, with grip in shock resistant plastic

thread "	code	
1/4	U09340004	5
3/8	U09340005	5
1/2	U09340006	5



### 934 C

#### Female threaded universal quick couplers with balls

- Brass body, Nickel plated, with grip in shock resistant plastic

thread	code	
1/4	U09340007	5
3/8	U09340008	5



### 935 B

#### Male threaded nipples for quick couplers

- Cylindrical thread
- Brass body, Nickel plated

thread	code	
1/4	U09350005	5



### 936 A

#### Universal quick couplers with balls and spiral spring

- Brass body, Nickel plated, with grip in shock resistant plastic

hose Ø mm	code	
6x8	U09360007	5
8x10	U09360008	5



### 937 B

#### Self-storing RILSAN hoses with bayonet connector and nipple for quick coupler

characteristics	size
Operating temperature (°C)	-40 ÷ +80
Recommended air pressure (bar)	6-6L: 29 / 8-8L: 18 / 10-10L: 17
Bursting pressure	6-6L: 63 / 8-8L: 50 / 10-10L: 39

n°	Ø tube mm	L mm	code	
10L	10x12	15	U09370015	1



### 939 C1

#### Air hose reel 10 mm

- Model with automatic hose rewind with holding device
- Shock resistant plastic casing with swivel bracket for attachment to wall
- Conformity to Machine Regulation 2006/42/CE and to the norms ISO EN 12100-1 e ISO EN 12100-2
- Can also be used outdoors
- Glossy polyurethane hose

characteristics	size
Hose length (m)	16
Ø internal hose (mm)	10
Max pressure (bar)	15
Length of feeding hose (m)	1,5
Output threaded male connector	3/8

LxPxH mm	kg	code	
450x400x230	8,0	U09390004	1



### 943 PC1 1/2"

#### Magnesium impact wrench with LED - the top

- Magnesium alloy casing: ultralight and powerful
- Aluminium motor housing
- Removable LED unit rechargeable with USB cable (3.7V 180 mAh Li-Ion battery)
- Reversible model with double hammer mechanism
- 3 tightening torque settings, always maximum untightening power
- Inversion and adjustment by Aluminium lever
- Progressive trigger
- Rubber side bumpers
- Balanced weight for maximum comfort
- Soft-touch bi-material handle
- Silencer and air exhaust integrated in the handle
- Spare rotor blades (8 pieces); code 1004755-63

characteristics	size
Square drive (")	1/2
Bolt capacity	M20
Max torque (Nm)	1898
Torque in use (Nm min-Max)	320÷460
Strokes per minute	1200
Free speed (rpm)	6500
Average air consumption (l/min)	172
Recommended air pressure (bar)	6,2
Sound level dB(A)	94 ±3
Sound power dB(A)	105 ±3
Vibrations (m/s²)	6,4
Air inlet (")	1/4
Ø internal hose (mm)	10

LxPxH mm	kg	code	
162x75x212	2,2	U09430001	1



### 943 PC1/C12

#### Assortment with hexagonal sockets and impact wrench in modular box (12 pcs.)

- Plastic box
- Ergonomic integrated handle
- Double metal closing clip
- Empty sheet steel box: code U09290005Q

pcs	description	item/size
10	Impact hexagonal sockets / 10-13-17-18-19-22-24-27-30-32	235 1/2 M
2	Lock pins	235 MCA/4-6
2	Safety rings	235 MDA/4-6
1	Impact extensions	236 1/2 M/125
1	Magnesium impact wrench with LED - the top	943 PC1 1/2

LxPxH mm	code	
415x283x92	U09430005	1



### 943 PC2 1/2"

#### Magnesium impact wrench with LED - extra compact

- Magnesium alloy casing: lightweight and powerful
- Aluminium motor housing
- Compact dimensions allow use in small spaces
- Removable LED unit rechargeable with USB cable (3.7V 180 mAh Li-Ion battery)
- Reversible model with double hammer mechanism
- 3 tightening torque settings, always maximum untightening power
- Inversion and adjustment by Aluminium lever
- Progressive trigger
- Rubber side bumpers
- Balanced weight for maximum comfort
- Soft-touch bi-material handle
- Silencer and air exhaust integrated in the handle
- Spare rotor blades (8 pieces); code 1004755-64

characteristics	size
Square drive (")	1/2
Bolt capacity	M16
Max torque (Nm)	950
Torque in use (Nm min-Max)	200÷270
Strokes per minute	1400
Free speed (rpm)	10000
Average air consumption (l/min)	167
Recommended air pressure (bar)	6,2
Sound level dB(A)	95 ±3
Sound power dB(A)	107 ±3
Vibrations (m/s²)	3,9
Air inlet (")	1/4
Ø internal hose (mm)	10

LxPxH mm	kg	code	
144x62x197	1,4	U09430002	1



1/2

### 942 PC3 1/2" ■ CE

#### Extra-compact impact wrench

- Extra compact structure: 11 cm length
- Reversible model with JUMBO percussion system
- Air exhaust through the handle
- 3 tightening torque settings, always maximum untightening power
- High resistance resin body
- Bi-material soft touch handle
- Side protections for engine carter
- Balanced weight for maximum comfort even for intensive use
- Spare rotor blades (6 pieces): code 1004760-65

characteristics	size
Square drive (")	1/2
Bolt capacity	M16
Max torque (Nm)	861
Torque range (Nm)	150-220
Strokes per minute	1650
Free speed (rpm)	10000
Average air consumption (l/min)	127
Recommended air pressure (bar)	6,2
Sound level dB(A)	91,1 ±3
Sound power dB(A)	108,1 ±3
Vibrations (m/s <sup>2</sup> )	9,57
Air inlet (")	1/4
Ø hose size (mm)	10

LxPxH mm	kg	code	
111x61,5x173	1,3	U09420012	1



1/2

### 942 PC3/C7 ■

#### Assortment with hexagonal sockets and impact wrench in modular box (7 pcs.)

- Plastic box
- Ergonomic integrated handle
- Double metal closing clip
- Empty sheet steel box: code U09420015Q

pcs	description	item/size
6	Impact hexagonal sockets / 13-17-19-21-22-24	235 1/2 M
1	Lock pins	235 MCA/4
1	Safety rings	235 MDA/4
1	Extra-compact impact wrench	942 PC3 1/2

LxPxH mm	code	
375x186x80	U09420015	1



3/4

### 942 PD1 3/4" ■ CE

#### Impact wrench (Titanium structure)

- Reversible model with double hammer
- One-piece motor
- Air exhaust through the handle
- 3 tightening torque settings, always maximum untightening power
- High-resistant material with Titanium front housing
- Soft-touch bimaterial handle
- Side soft bumpers
- Balanced weight for maximum comfort even for intensive use
- Spare rotor blades (6 pieces): code 30M100111

characteristics	size
Square drive (")	3/4
Bolt capacity	M27
Max torque (Nm)	2115
Torque in use (Nm min-Max)	500÷800
Strokes per minute	950
Free speed (rpm)	5300
Average air consumption (l/min)	200
Recommended air pressure (bar)	6,2
Sound level dB(A)	97,8 ±3
Sound power dB(A)	108,8 ±3
Vibrations (m/s <sup>2</sup> )	5,06
Air inlet (")	3/8
Ø hose size (mm)	10

LxPxH mm	kg	code	
227x97x227	3,8	U09420004	1



1

### 942 PE1 1" ■ CE

#### Impact wrench (composite material frame)

- Lightweight and balanced for easy use, only 6.8 Kg
- Reversible model with double hammer
- Progressive trigger
- Air exhaust through the handle
- 2 tightening torque settings, always maximum untightening power
- Soft-touch bimaterial grip
- Additional soft-touch bimaterial handle allows strong and firm grip
- Socket retaining system on square drive with holding ring and hole to be used with lock pin and safety ring
- Spare rotor blades (6 pieces): code 30M200147

characteristics	size
Square drive (")	1
Bolt capacity	M38
Max torque (Nm)	3390
Torque in use (Nm min-Max)	203÷1627
Strokes per minute	900
Free speed (rpm)	5000
Average air consumption (l/min)	440
Recommended air pressure (bar)	6,2
Sound level dB(A)	100,9 ±3
Sound power dB(A)	111,9 ±3
Vibrations (m/s <sup>2</sup> )	10,6
Air inlet (")	1/2
Ø hose size (mm)	19

LxPxH mm	kg	code	
243x96x249	6,8	U09420005	1



1

### 942 PE2 1" ■ CE

by EFFCON

#### Reversible straight impact wrench with long anvil (composite material frame)

- Lightweight and balanced for easy use, only 8 Kg
- Reversible model with double hammer
- Progressive trigger
- Air exhaust through the handle, at 45°
- 2 tightening torque settings, always maximum untightening power
- Soft-touch bimaterial grip
- Additional soft-touch bimaterial handle allows strong and firm grip
- Socket retaining system on square drive with holding ring and hole to be used with lock pin and safety ring
- Spare rotor blades (6 pieces): code 30M200147

characteristics	size
Square drive (")	1
Bolt capacity	M38
Max torque (Nm)	3390
Torque in use (Nm min-Max)	203÷1627
Strokes per minute	1000
Free speed (rpm)	5000
Average air consumption (l/min)	480
Recommended air pressure (bar)	6,2
Sound level dB(A)	104,4 ±3
Sound power dB(A)	115,4 ±3
Vibrations (m/s <sup>2</sup> )	14,75
Air inlet (")	1/2
Ø hose size (mm)	19

LxPxH mm	kg	code	
346x101x97	8	U09420009	1



# 1

## 942 PEL2 1" ■ CE

### Reversible straight impact wrench with long anvil (composite material frame)

- Lightweight and balanced for easy use, only 9 Kg
- Reversible model with double hammer
- Long-reach anvil for access in hard to reach areas
- Progressive trigger
- Air exhaust through the handle, at 45°
- 2 tightening torque settings, always maximum untightening power
- Soft-touch bimaterial grip
- Additional soft-touch bimaterial handle allows strong and firm grip
- Socket retaining system on square drive with holding ring and hole to be used with lock pin and safety ring
- Spare rotor blades (6 pieces): code 30M100147

characteristics	size
Square drive (")	1
Max torque (Nm)	3390
Torque in use (Nm min-Max)	203÷1627
Strokes per minute	1000
Free speed (rpm)	5000
Average air consumption (l/min)	480
Recommended air pressure (bar)	6,2
Sound level dB(A)	105 ±3
Sound power dB(A)	116 ±3
Vibrations (m/s <sup>2</sup> )	15,6
Air inlet (")	1/2
Ø hose size (mm)	19

LxPxH mm	kg	code
493x97x101	9	U09420007 1



## 960 DIN 862 ISO 13385-1

### Vernier caliper to 1/20 mm

- Beam and vernier of hardened stainless steel with protruding sliding guides
- Matt Chrome beam and vernier, anti-reflective
- Monobloc slider with lever lock
- Supplied in a plastic sheath

blades n°	vernier mm/inch	a mm	L mm	code
150/6"	0,05/ 1/128"	40	232	U09600010 1



## 960 C DIN 862 ISO 13385-1

### Vernier calipers to 1/50 mm

- Beam and vernier of hardened stainless steel with protruding sliding guides
- Matt Chrome beam and vernier, anti-reflective
- Tapered nose for inside measurement (from 10 mm)
- Micrometric adjustment with screw lock
- Supplied in a wooden case

capacity mm	vernier mm	a mm	L mm	code
200/8	0,02	65	330	U09600020 1
300/12	0,02	90	460	U09600021 1



## 960 D DIN 862 ISO 13385-1

### Digital vernier caliper 1/100

- Stainless steel body
- Reading scale mm/inch
- Digit height: 9 mm
- Depth measurement with shaft 3,6x1,3 mm
- Slider screw lock
- Supplied in a plastic case

capacity mm	vernier mm/inch	a mm	L mm	code
150/6"	0,01/0,0005"	40	235	U09600015 1

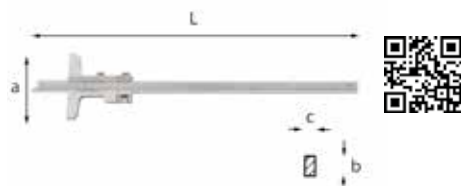

## 963 DIN 862 ISO 13385-2

### Sliding depth gauges to 1/50 mm

- Beam and vernier of hardened stainless steel with protruding sliding guides
- Matt Chrome beam and vernier, anti-reflective
- Micrometric adjustment with screw lock
- Supplied in a wooden case

capacity mm	vernier mm	axL mm	bxc mm	code
200	0,02	80x290	14x4	U09630001 1
300	0,02	80x390	14x4	U09630002 1



## 966 Thickness gauges

- Conic-shaped blades with rounded tips

blades n°	blades thickness mm	L mm	code
8	0,05÷0,50	100	U09660001 5
13	0,05÷1,00	100	U09660002 5
20	0,05÷1,00	100	U09660003 5



## 966 L Thickness gauges with long blades

- Conic-shaped blades with rounded tips

blades n°	blades thickness mm	L mm	code
19	0,04÷1,00	155	U09660004 1



## 967 DIN 862 ISO 3611

### Micrometers for outside measurement to 1/100 mm

- Anvil made of hardened steel, contact surfaces with hard metal inserts
- Matt Chrome bow frame and thimble, anti-reflective
- Friction-operated thimble and lever lock
- Supplied in a wooden case with setting gauge and calibration key

capacity mm	resolution mm	a mm	L mm	code
0÷25	0,01	6,5	126	U09670001 1
25÷50	0,01	6,5	153	U09670002 1
50÷75	0,01	6,5	180	U09670003 1
75÷100	0,01	6,5	206	U09670004 1

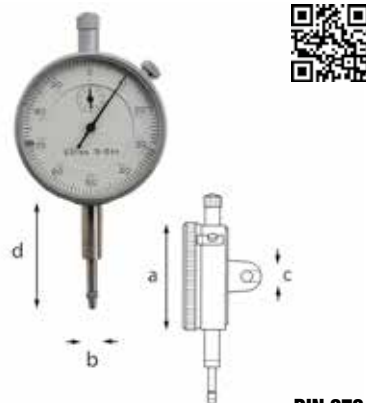

## 968 DIN 878

### Dial indicator to 1/100 mm

- Rack-type feeler of hardened stainless steel, threaded tip (M 2,5) for interchangeable styluses
- Matt Chrome steel casing, anti-reflective
- White rotating dial with adjustable tolerance markers and transparent shatterproof protection glass
- Micrometric screw for manual zero-setting
- Supplied in a wooden case

capacity mm	resolution mm	axbxc mm	d mm	code
10	0,01	58x8x6	40	U09680001 1



## 968 M Magnetic support for dial indicators

- Magnetic adherence force: 600 N
- Intermediate beam height: 150 mm
- Dial indicator clamp Ø: 6-8 mm
- Joints with quick-sliding jaws
- Lever switch

h max mm	base mm	Ø mm	Ø1 mm	code
365	70x65x50	10	12	U09680010 1



969

DIN 2270

**Dial indicator to 1/100 mm with contact stylus**

- Matt Chrome monobloc steel body, anti-reflective
- Hard metal stylus,  $\varnothing$  2,5 mm
- High-precision clockwork with ruby bearing
- Feeler tiltable to 220° perpendicular to the dial
- Automatic inversion of measuring direction
- Zero-setting by dial rotation
- Supplied in a wooden case with feeler shafts  $\varnothing$  4 and 8 mm

capacity mm	resolution mm	scale	b mm	code	
0,8	0,01	0-40	12,5	U09690001	1

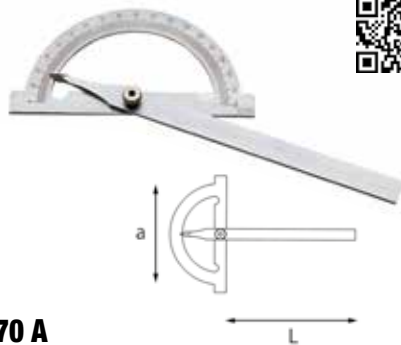

970 A

**Standard steel protractors**

- Matt Chrome plated scale, anti-reflective
- Screw lock

a mm	scale	resolution	L mm	code	
120	0°÷180°	1°	150	U09700001	1
150	0°÷180°	1°	200	U09700002	1
200	0°÷180°	1°	300	U09700003	1

970 CN

**Universal protractor**

- Sliding rule and hook of hardened stainless steel
- Matt Chrome plated scale and vernier, anti-reflective, with magnifying glass
- Sliding rule with 45° and 60° ends
- Supplied in a plastic case

scale	vernier	shaft mm	code	
4x90°	1/12°-5°	300	U09700009	1



972

**Precision dividers**

- Fast opening model with fine adjustment screw
- Straight tips made of special hardened steel
- Ground finish

blades n°	L mm	code	
200	245	U09720002	1
250	295	U09720003	1



974

**Scriber**

- Monobloc scriber made of special hardened steel
- Plastic grip
- One straight tip and one tip bent at 110°
- Burnished finish

L mm	code	
220	U09740001	5



974 A

**Carbide scriber**

- Monobloc steel scriber, pen-type with pocket clip
- Tungsten carbide tip
- Galvanized finish

L mm	code	
150	U09740002	5



974 BN

**Retractable carbide scriber**

- Pen-type steel body with pocket clip
- Double-dressed retractable tip of tungsten carbide

$\varnothing$ tip mm	L mm	code	
2	150	U09740013	2



974 BNR

**Spare tip**

- For scribers 974 BN

gr	code	
1	U09740013Q	5



974 M

**Carpenter's pencil**

L mm	code	
178	U09740020	10



976

DIN 875

**Standard squares**

- Precision class DIN 875/2
- Normalized steel with ground faces and edges

L mm	a mm	bxc mm	code	
100	70	20x8	U09760003	1
150	100	25x8	U09760004	1
200	130	30x8	U09760005	1
250	165	35x8	U09760006	1
300	200	35x8	U09760007	1

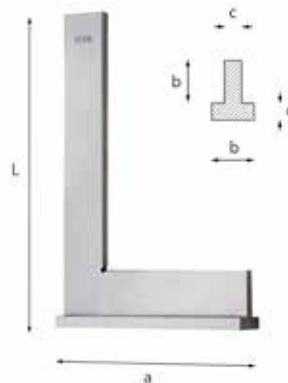

976 C

DIN 875

**Back squares**

- Precision class DIN 875/2
- Normalized steel with ground faces and edges

L mm	a mm	bxc mm	code	
100	70	20x8	U09760013	1
150	100	25x8	U09760014	1
200	130	30x8	U09760015	1
250	165	35x8	U09760016	1
300	200	35x8	U09760017	1



978 A

MID 2014/32/UE

**Flexible graduated rules**

- Precision class II
- Matt Chrome stainless steel, anti-reflective
- Double graduation photoengraved on both sides (on one side only for 1000 mm rule)

L mm	scale	section mm	code	
150	mm/ 1/2 mm	13x0,5	U09780002	5
200	mm/ 1/2 mm	13x0,5	U09780003	5
300	mm/ 1/2 mm	13x0,5	U09780005	5
500	mm/ 1/2 mm	20x0,5	U09780006	2
1000	mm/ 1/2 mm	25x0,5	U09780007	2



### 978 B

MID 2014/32/UE

#### Semi-rigid graduated rules

- Precision class II
- Matt Chrome stainless steel, anti-reflective
- Double graduation photoengraved on both sides (on one side only for 1000 mm rule)

L mm	scale	section mm	code	
300	mm/ 1/2 mm	30x0,8	U09780015	2
500	mm/ 1/2 mm	30x0,8	U09780016	2
1000	mm/ 1/2 mm	30x0,8	U09780017	2



### 981 A

MID 2014/32/UE

#### Professional tape rules with shockproof covering

- Precision class II
- Shockproof ABS casing
- The coating ensures maximum grip while using
- The outside rubber protects casing from dust and oils
- Anti-slip up to a slope of 42 ° (support surface)
- Steel belt coated with anti-reflective nylon, anti-corrosion and anti-wear nylon
- The stiffness of the tape, before bending, is guaranteed up to 3 meters
- Multi-grip metal hook fixed to the tape with 3 rivets
- Stop button with automatic tape rewind
- Stainless steel clip

L mm	scale	tape width mm	code	
3	mm	19	U09810036	1
5	mm	28	U09810037	1
8	mm	28	U09810038	1



### 981 C

#### Tape rules with ABS casing

- Precision class II
- Ergonomic ABS casing
- Steel tape coated with anti-reflective, anti-corrosion and anti-wear nylon
- The stiffness of the tape, before bending, is guaranteed up to 1.5 meters
- Metal hook fixed to the tape with two rivets
- Stop button and automatic tape rewind
- Stainless steel clip

L mm	scale	tape width mm	code	
3	mm	16	U09810003	1



### 982 A 20

#### Steel tape rules

- Precision class II
- Closed casing of shatterproof ABS
- Hardened steel tape, anti-corrosion and anti-wear treated
- Rewinding system with winding handle
- Graduation in black on enamelled yellow background with meter indication in red

L mm	scale	tape width mm	code	
20	mm - cm	13	U09820016	1



### 982 AL

#### Steel tape rule with handle

- Precision class II
- Aluminium body, handle of shatterproof plastic
- Hardened steel tape, anti-corrosion and anti-wear treated
- Rewinding system with winding handle
- Graduation in black on enamelled yellow background with meter indication in red
- Supplied in a plastic case

L mm	scale	tape width mm	code	
50	cm	13	U09820017	1



### 982 FV

MID 2014/32/UE

#### Fiberglass tape rules

- Precision class III
- Closed casing of shatterproof ABS
- Fiberglass tape, PVC-coated
- Rewinding system with winding handle
- Graduation on both sides, black on white background with meter indication in red

L mm	scale	tape width mm	code	
10	cm	15	U09820018	1
20	cm	15	U09820019	1



### 984

#### Aluminium levels

- Body of profiled Aluminium, enamelled
- Shatterproof vials (5 years guarantee)
- Fluorescent liquid, unaffected by temperatures from -50° to +50°C
- Non-dispersing bubble
- Adjustable horizontal vial

L mm	base mm	precision	code	
150	22	0,057° = 1 mm/m	U09840001	1
400	22	0,057° = 1 mm/m	U09840002	1
500	22	0,057° = 1 mm/m	U09840003	1
600	22	0,057° = 1 mm/m	U09840004	1
800	22	0,057° = 1 mm/m	U09840005	1



### 984 MN

#### Aluminium levels with magnetic base

- Enamelled Aluminium body with ground base
- Shatterproof vials (5 years guarantee)
- Fluorescent liquid, unaffected by temperatures from -50°C to +50°C
- Non-dispersing bubble
- Adjustable and replaceable horizontal vial

L mm	base mm	precision	code	
300	22	0,057° = 1 mm/m	U09840024	1
400	22	0,057° = 1 mm/m	U09840025	1
500	22	0,057° = 1 mm/m	U09840026	1



### 984 RH

#### Spare horizontal vial

- For levels 984 and 984 MN

LxPxH mm	g	code	
87x16,5x16	14	U09840002Q	1



### 984 L

DIN 877

#### Straight precision level

- For checking and positioning machine tool
- Cast-iron body with ground prismatic base
- Adjustable horizontal vial
- Supplied in a wooden case

L mm	base mm	precision	code	
200	40	0,05 mm/m	U09840032	1



### 984 Q

DIN 877

#### Square frame precision levels

- For checking and positioning machine tools
- Cast-iron body with ground prismatic and flat bases
- Adjustable horizontal vial
- Supplied in a wooden case

L mm	base mm	precision	code	
150	40	0,05 mm/m	U09840042	1
200	45	0,05 mm/m	U09840043	1



## 987 E

### Flexible scrapers

- Flexible stainless steel blade with polished finish
- Ergonomic anti-slip bimaterial grip

a mm	L mm	code	
32	218	U09870041	5
50	218	U09870042	5
75	218	U09870043	5



## 987 E/S3

### Set of 3 flexible scrapers

- Flexible stainless steel blade with polished finish
- Ergonomic anti-slip bimaterial grip

pcs	description	item/size
3	Flexible scrapers/32-50-75	987 E

à gr	code	
210	U09870050	1



## 987 F

### Rigid scrapers

- Rigid stainless steel blade
- Straight model (32-50) and bent model (32P)
- Ergonomic anti-slip bimaterial grip
- Steel dome on the rear

a mm	L mm	code	
32	218	U09870046	5
32P	218	U09870047	5
50	218	U09870048	5



## 987 F/S3

### Set of 3 rigid scrapers

- Rigid stainless steel blade
- Straight model (32-50) and bent model (32P)
- Ergonomic anti-slip bimaterial grip
- Steel dome on the rear

pcs	description	item/size
3	Rigid scrapers/32-32P-50	987 F

à gr	code	
370	U09870051	1



## 988 A

### Cutter for welding spots

- For removing welding spots without deforming the sheet steel
- Reversible cutter in High Speed steel

L mm	a mm	b mm	ø mm	code	
70	9,6	2,5	7	U09880001	1



## 988 AR

### Spare cutter and awl

- For cutters 988 A

à gr	code	
6	U09880005Q	5



## 988 B

### Drills for welding spots

- Re grindable self-centering High Speed steel drill

ø mm	L mm	code	
6	66	U09880004	2
8	80	U09880005	2
10	88	U09880006	2

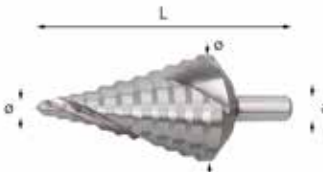

## 988 D

### Stepped cutters

- For making round holes in ferrous and non-ferrous materials
- No pilot-hole required
- HSS steel

n°	capacity	ø min-max mm	a mm	L mm	code	
1	4÷12	6	65	U09880011	1	
2	4÷20	8	75	U09880012	1	
3	4÷30	10	100	U09880013	1	
4	6÷38	10	100	U09880014	1	
5	6,5÷40,5	10	96	U09880015	1	
6	6÷37 PG	10	100	U09880016	1	



## 988 D/S3

### Set in sheet steel case (3 pcs.)

- Supplied with three stepped cutters 988 D/1-2-3
- For making round holes in ferrous and non-ferrous materials
- No pilot-hole required
- HSS steel

pcs	description	item/size
1	Stepped cutters/4÷12-4÷20-4÷30	988 D

LxPxH mm	à gr	code	
150x112x35	500	U09880020	1



## 988 EA

### Rotary burrs in hard metal

- To work special steel, stainless steel, generic ferrous materials and plastics
- High cutting capacity
- Shaft Ø 6mm

b mm	L mm	code	
10	60	U09880038	1
12	65	U09880039	1



## 988 EC

### Rotary burrs in hard metal

- To work special steel, stainless steel, generic ferrous materials and plastics
- High cutting capacity
- Shaft Ø 6mm

b mm	L mm	code	
10	60	U09880042	1
12	65	U09880043	1



## 988 ED

### Rotary burrs in hard metal

- To work special steel, stainless steel, generic ferrous materials and plastics
- High cutting capacity
- Shaft Ø 6mm

b mm	L mm	code	
10	50	U09880046	1
12	50	U09880047	1





### 988 EF

#### Rotary burrs in hard metal

- To work special steel, stainless steel, generic ferrous materials and plastics
- High cutting capacity
- Shaft Ø 6mm

b mm	L mm	code	
10	60	U09880050	1
12	65	U09880051	1

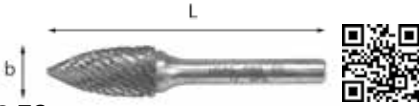

### 988 EG

#### Rotary burrs in hard metal

- To work special steel, stainless steel, generic ferrous materials and plastics
- High cutting capacity
- Shaft Ø 6mm

b mm	L mm	code	
10	60	U09880054	1
12	65	U09880055	1



### 988 EM

#### Rotary burrs in hard metal

- To work special steel, stainless steel, generic ferrous materials and plastics
- High cutting capacity
- Shaft Ø 6mm

b mm	L mm	code	
10	60	U09880058	1
12	65	U09880059	1



### 988 E/S10

#### Set of ten rotary burrs in hard metal

- Supplied with 10 pieces in sheet steel box: 8 pcs. (Ø 10 and 12 shapes EA-EC-EF-EG) 2 pcs (Ø 12 shapes ED-EM)
- To work special steel, stainless steel, generic ferrous materials and plastics
- High cutting capacity
- Shaft Ø 6mm

pcs	description	item/size
2	Rotary burrs in hard metal	988 EA/10-12
2	Rotary burrs in hard metal	988 EC/10-12
1	Rotary burrs in hard metal	988 ED/12
2	Rotary burrs in hard metal	988 EF/10-12
2	Rotary burrs in hard metal	988 EG/10-12
1	Rotary burrs in hard metal	988 EM/12

LxPxH mm	kg	code	
150x112x35	600	U09880062	1



### 988 G

#### Bimetallic hole saws

- To bore any kind of material with thin thickness
- Variable toothting in HSS steel
- Side notches
- Cutting depth Max 38 mm

a mm	L mm	code	
19	51	U09880102Q	1
22	51	U09880103Q	1
25	51	U09880105Q	1
29	51	U09880108Q	1
35	51	U09880111Q	1
38	44	U09880113Q	1
40	50	U09880114Q	1
44	44	U09880116Q	1
51	44	U09880119Q	1
57	44	U09880121Q	1
64	44	U09880124Q	1



### 988 GA2

#### Bimetallic hole saws

- Adapter for bimetallic hole saws by 35÷64

kg	code	
140	U09880135Q	1



### 988 GA4

#### Bimetallic hole saws

- Adapter for bimetallic hole saws by 19÷29

kg	code	
30	U09880137Q	1



### 988 G/S12

#### Set of 10 bimetallic hole saws

- Supplied in plastic case with: 10 pcs 988 G (Ø 19-22-25-29-35-38-44-51-57-64) 1 pc 988 GA2 Adapter for bimetallic hole saws by 35÷64 1 pc 988 GA4 Adapter for bimetallic hole saws by 19÷29
- To bore any kind of material with thin thickness
- Variable toothting in HSS steel
- Side notches
- Cutting depth Max 38 mm

pcs	description	item/size
10	Bimetallic hole saws / 19-22-25-29-35-38-44-51-57-64	988 G

kg	code	
1,2	U09880100	1



### 988 LA/S14

#### Assortment with tap and drills

- Assortment with tap and drills for standard and through holes HSS-G
- Grinded
- Supplied in ABS box
- Ø drills: 2,5-3,3-4,2-5,0-6,8-8,5-10,2
- M taps: 3x0,5-4x0,7-5x0,8-6x1-8x1,25-10x1,5-12x1,75

kg	code	
560	U09880070	1



### 988 MA/S19

#### Assortment with drills

- Assortment with HSS-G drills
- Grinded
- Supplied in ABS box
- Ø drills: 1,0-1,5-2,0-2,5-3,0-3,5-4,0-4,5-5,0-5,5-6,0-6,5-7,0-7,5-8,0-8,5-9,0-9,5-10,0

kg	code	
600	U09880073	1



### 988 MA/S25

#### Assortment with drills

- Assortment with HSS-G drills
- Grinded
- Supplied in ABS box
- Ø drills: 1,0-1,5-2,0-2,5-3,0-3,5-4,0-4,5-5,0-5,5-6,0-6,5-7,0-7,5-8,0-8,5-9,0-9,5-10,0-10,5-11,0-11,5-12,0-12,5-13,0

kg	code	
1,23	U09880074	1



NEW

## 988 S

by **FACOM**

### Round dies

- ISO metric RH thread
- Chrome-vanadium HSS hardened to 62/64 HRC (234 daN/mm<sup>2</sup>)
- Tapered adjusting screw

M	Ø outside x thickness	h gr	code	
3x0,5	25,4x8	25	U09880080	1
4x0,7	25,4x8	25	U09880081	1
5x0,8	25,4x8	30	U09880082	1
6x1	25,4x9	30	U09880083	1
7x1	25,4x9	30	U09880084	1
8x1,25	25,4x9	30	U09880085	1
9x1,25	25,4x9	30	U09880086	1
10x1,5	38,1x13	80	U09880087	1
12x1,75	38,1x13	90	U09880088	1



NEW

## 988 T

by **FACOM**

### Hand taps

- Steel HSS
- Pack with 3 taps (taper, second and bottoming)

M	L mm	mm	h gr	code	
3x0,5	48	2,5	20	U09880089	1
4x0,7	53	3,1	25	U09880090	1
5x0,8	58	4	40	U09880091	1
6x1	66	5	50	U09880092	1
7x1	66	5,6	60	U09880093	1
8x1,25	72	6,3	85	U09880094	1
9x1,25	72	7,1	100	U09880095	1
10x1,5	80	8	140	U09880096	1
12x1,75	89	7,1	150	U09880097	1

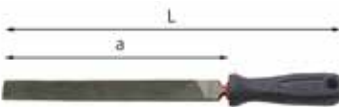

## 990 B PA

ISO 234 DIN 7285

### Flat square file

- Bastard cut
- Plastic handgrip

L mm	a "	a mm	code	
200	8	200	U09900136	5

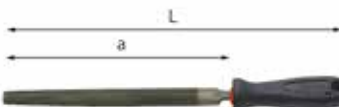

## 990 B PB

ISO 234 DIN 7285

### Half-round file

- Bastard cut
- Plastic handgrip

a mm	a "	L mm	code	
200	8	320	U09900137	5



## 990 B PC

ISO 234 DIN 7285

### Round file

- Bastard cut
- Plastic handgrip

a mm	a "	L mm	code	
200	8	320	U09900138	5



## 990 B PD

ISO 234 DIN 7285

### Square file

- Bastard cut
- Plastic handgrip

a mm	a "	L mm	code	
200	8	320	U09900139	5



## 990 B PE

ISO 234 DIN 7285

### Triangular file

- Bastard cut
- Plastic handgrip

a mm	a "	L mm	code	
200	8	320	U09900140	5



## 990 B2/SE5

### Set of 5 files (990 B PA÷B PE)

- Supplied in plastic pouch
- Bastard cut
- Plastic handgrip

pcs	description	item/size
1	Flat square file	990 B PA/200
1	Half-round file	990 B PB/200
1	Round file	990 B PC/200
1	Square file	990 B PD/200
1	Triangular file	990 B PE/200

h gr	code	
850	U09900404	1



## 990 M PA

ISO 234 DIN 7285

### Flat square file

- Second cut
- Plastic handgrip

a mm	a "	L mm	code	
200	8	320	U09900116	5



## 990 M PB

ISO 234 DIN 7285

### Half-round file

- Second cut
- Plastic handgrip

a mm	a "	L mm	code	
200	8	320	U09900117	5

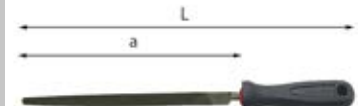

## 990 M PC

ISO 234 DIN 7285

### Round file

- Second cut
- Plastic handgrip

a mm	a "	L mm	code	
200	8	320	U09900118	5



## 990 M PD

ISO 234 DIN 7285

### Square file

- Second cut
- Plastic handgrip

a mm	a "	L mm	code	
200	8	320	U09900119	5

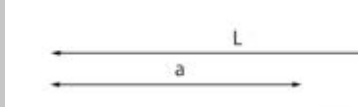

## 990 M PE

ISO 234 DIN 7285

### Triangular file

- Second cut
- Plastic handgrip

a mm	a "	L mm	code	
200	8	320	U09900120	5



### 990 M2/SE5

#### Set of five files (990 M PA+M PE)

- Supplied in plastic pouch
- Second cut
- Plastic handgrip



pcs	description	item/size
1	Flat square file	990 M PA/200
1	Half-round file	990 M PB/200
1	Round file	990 M PC/200
1	Square file	990 M PD/200
1	Triangular file	990 M PE/200

ã gr	code	5
826	U09900405	1



### 990 F

#### Flat file and rasp

- Second cut and rough cut
- Plastic handgrip

a mm	a "	L mm	code	5
200	8	320	U09900086	5



### 990/1

#### Spare handgrip

- For files BPA-BPB-BPC-F-MPA-MPB-MPC

ã gr	code	5
35	U09900011	5

### 990/2

#### Spare handgrip

- For files BPD-BPE-MPD-MPE

ã gr	code	5
35	U09900012	5



### 990 RV9

#### Empty holders for files and scrapers

- Enamelled sheet steel
- Supplied without screws

L mm	ã gr	code	5
330	165	U09900100Q	1



### 991 A

#### Flat needle file with flat edges

- Second cut

UNI 5669

L mm	a mm	b mm	code	5
160	80	3,5	U09910001	5



### 991 B

#### Triangular needle file

- Second cut

UNI 5670

L mm	a mm	b mm	code	5
160	80	3,5	U09910002	5

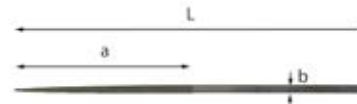

### 991 C

#### Round needle file

- Second cut

UNI 5670

L mm	a mm	b mm	code	5
160	80	3,5	U09910003	5



### 991 D

#### Slitting needle file

- Second cut

UNI 5669

L mm	a mm	b mm	code	5
160	80	3,5	U09910004	5

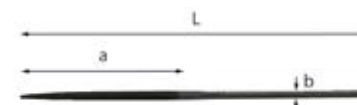

### 991 E

#### Square needle file

- Second cut

UNI 5670

L mm	a mm	b mm	code	5
160	80	3,5	U09910005	5



### 991 F

#### Flat tapering needle file

- Second cut

UNI 5670

L mm	a mm	b mm	code	5
160	80	3,5	U09910006	5

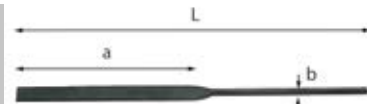

### 991 G

#### Flat needle file with round edges

- Second cut

UNI 5669

L mm	a mm	b mm	code	5
160	80	3,5	U09910007	5



### 991 H

#### Half-round needle file

- Second cut

UNI 5670

L mm	a mm	b mm	code	5
160	80	3,5	U09910008	5



### 991 I

#### Half-round needle file

- Second cut

UNI 5670

L mm	a mm	b mm	code	5
160	80	3,5	U09910009	5

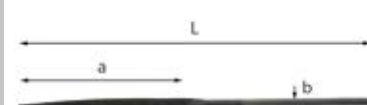

### 991 J

#### Crossing needle file

- Second cut

UNI 5670

L mm	a mm	b mm	code	5
160	80	3,5	U09910011	5



### 991 K

#### Knife needle file

- Second cut

UNI 5670

L mm	a mm	b mm	code	5
160	80	3,5	U09910012	5



### 991 L

#### Bar needle file

- Second cut

UNI 5670

L mm	a mm	b mm	code	5
160	80	3,5	U09910013	5



### 991 SE6

#### Set of 6 needle files

- Supplied in plastic pouch (A-B-C-E-F-I)
- Second cut

pcs	description	item/size
1	Flat needle file with flat edges	991 A/160
1	Triangular needle file	991 B/160
1	Round needle file	991 C/160
1	Square needle file	991 E/160
1	Flat tapering needle file	991 F/160
1	Half-round needle file	991 I/160

à gr	code	
80	U09910021	1



### 991 SE12

#### Set of 12 needle files

- Supplied in plastic wallet (A÷L)
- Second cut

pcs	description	item/size
1	Flat needle file with flat edges	991 A/160
1	Triangular needle file	991 B/160
1	Round needle file	991 C/160
1	Slitting needle file	991 D/160
1	Square needle file	991 E/160
1	Flat tapering needle file	991 F/160
1	Flat needle file with round edges	991 G/160
1	Half-round needle file	991 H/160
1	Half-round needle file	991 I/160
1	Crossing needle file	991 J/160
1	Knife needle file	991 K/160
1	Bar needle file	991 L/160

à gr	code	
140	U09910022	1



### 993 A

#### Metal brush

- Model with stainless steel wire bristles

L mm	code	
270	U09930001	5



### 993 B

#### Metal brush for disk brake-shoes

- For cleaning disk brake-shoes
- Steel bristles

L mm	code	
225	U09930003	5



### 993 C

#### Brush for spark plugs

- For cleaning electrodes
- Brass wires

L mm	code	
150	U09930005	5



### 995 A

#### Hand riveter

- Light alloy body
- Pressed sheet steel pressure lever
- Handgrips with spring-action opening
- Supplied with three interchangeable nozzles and service key

capacity	L mm	b mm	code		
3-4-5	2,4÷4	273	22	U09950001	1



### 995 K

#### Assortment in plastic case (501 pcs.)

- High resistance ABS case with quick closing system
- The inside tray is studied to be stored in USAG roller cabinet drawers
- Empty inner plastic tray: code U05190139Q

pcs	description	item/size
1	Hand riveter	995 A
100	Aluminium rivets	995 AL/3x10
100	Aluminium rivets	995 AL/4x10
100	Aluminium rivets	995 AL/3x8
100	Aluminium rivets	995 AL/4x12
100	Aluminium rivets	995 AL/4,8x12
1	Bi-colour foam module (empty)	519 M.995KV
1	Empty ABS case - size L	606 L

LxPxH mm	à Kg	code	
435x270x70	2	U09950025	1



### 995 AF

#### Hand riveter with swivel head

- 360° adjustable head
- Suitable for Aluminum rivets
- 4 interchangeable heads
- Light alloy body
- Plastic handles
- Metal clip for opening lock
- Supplied with head disassembly key



capacity	L mm	b mm	code	
2,4÷4,8	285	22,5	U09950006	1



### 995 LA

#### Straight compact hand riveter

- Compact model with the same capacity as a standard long riveter
- The internal lever system reduces operator effort
- Suitable for Aluminum and steel rivets
- 5 interchangeable heads
- Removable holder for spent nails
- Light alloy body
- Plastic handles



capacity	L mm	code	
2,4-6,4	330	U09950004	1



### 995 CA

#### Hand riveter for blind-nut rivets

- Compact model with internal lever system that reduces operator effort
- Supplied with 4 interchangeable heads (M4-M5-M6-M8)
- To be used with aluminium and steel blind nuts (M4-M5-M6-M8) and stainless steel (M4-M5)
- Light alloy body
- Plastic handles
- Supplied in a plastic case (LxDxH: 320x175x50 mm) with blind nuts holders (not included)

LxPxH mm	à Kg	code	
320x175x50	1,6	U09950008	1



## 995 AC

### Blind-nut rivets

- Steel body
- Zinc chrome plated finish
- Pack of 100 pcs.

M ø mm	a mm	b mm	L mm	code	
4	5,7	6,8	10,1	U09950131	1
5	6,7	8,2	12	U09950132	1
6	8,8	10,2	13,8	U09950133	1
8	10,7	12	16,5	U09950134	1



## 995 AL

### Aluminium rivets

- Standard round head
- Aluminium alloy with Zinc plated steel rivet
- Pack of 100 pcs.

a mm	b mm	c mm	Ø hole mm	code	
3	8	6,5	3	U09950010	1
3	10	6,5	3	U09950011	1
3	12	6,5	3	U09950012	1
4	10	8	4	U09950013	1
4	12	8	4	U09950014	1
4	14	8	4	U09950015	1
4	16	8	4	U09950016	1
4,8	12	9,5	5	U09950017	1
4,8	14	9,5	5	U09950018	1
4,8	16	9,5	5	U09950019	1
4,8	20	9,5	5	U09950020	1

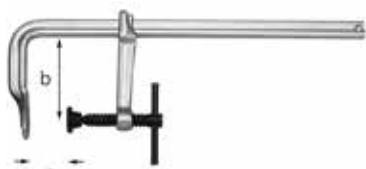

## 997 A

### Screw-type clamp

- Basic model
- Body and sliding arm in forged steel
- Pressure screw with adjustable joint

a mm	b mm	section mm	kg	code	
160	80	16x7,5	0,5	U09970002	2
200	100	19,5x9,5	0,9	U09970003	2
250	120	22x10,5	1,2	U09970004	2
300	140	25x12	1,8	U09970005	2
400	120	25x12	1,9	U09970006	2
500	120	25x12	2,1	U09970007	2
600	120	25x12	2,3	U09970008	2
800	120	27x13	3,3	U09970009	1
1000	120	27x13	3,7	U09970010	1



## 997 B

### Lever-type clamp

- Quick lever model with precise regulation
- Body and sliding arm in forged steel
- Adjustable pressure cap

a mm	b mm	section mm	kg	code	
120	60	13,5x6,5	0,7	U09970013	2
160	80	16x7,5	1	U09970014	2
200	100	19,5x9,5	1,3	U09970015	2
250	120	22x10,5	1,9	U09970016	2
300	140	25x12	2,7	U09970017	2
400	120	25x12	2,8	U09970018	2
500	120	25x12	3	U09970019	2



## 1308 K1

### Timing tool set for NISSAN/OPEL/RENAULT

- DIESEL (belt) engines: 1.5 DCi, 1.9 DCi, 1.9 DTi, 1.9 CDTi (F9Q), 2.2 DCi, 2.2 Dti, 2.5 Dci, 2.5 DCTi

kg	code	
2,3	U13080085	1



## 1308 K3

### Timing set for RENAULT/NISSAN/OPEL

- DIESEL (chain) engine: 1.6 dCi, 2.0 CDTi, 2.0 dCi, 2.0 GT dCi

kg	code	
3,5	U13080087	1



## 1309 K1

### Timing set for MINI/PEUGEOT/CITROEN/BMW

- DIESEL (chain) engines: 1.6 114d, 1.6 116d Efficient Dynamics, 1.6 One D, 1.6 Cooper D, 2.0 116d, 2.0 118d, 2.0 118d/xDrive, 2.0 120d, 2.0 120d/xDrive, 2.0 123d, 2.0 125d, 2.0 316d, 2.0 318d, 2.0 320d, 2.0 320d/xDrive, 2.0 320d Efficient Dynamics, 2.0 325d, 2.0 520d, 2.0 520d GT, 2.0 520d/xDrive, 2.0 520d Efficient Dynamics, 2.0 525d/xDrive, 2.0 Cooper D, 2.0 Cooper SD, 2.0, 2.0 sDrive16d, 2.0 sDrive18d, 2.0 sDrive20d, 2.0 sDrive20d Efficient Dynamics, 2.0 xDrive18d, 2.0 xDrive20d, 2.0 xDrive23d, 2.0 xDrive25d
- DIESEL (belt) engines: 1.6 HDi, 1.6 HDi VTS

kg	code	
1,5	U13090085	1



## 1311 K1

### Timing tool set for FORD/MAZDA

- DIESEL (belt) engines: 1.4 TDCi, 1.6 D, 1.6 TDCi, 1.8 D, 1.8 D TURBO, 1.8 TDCi, 1.9 TDI PD, 2.5 D, 2.5 D TURBO

kg	code	
2,2	U13110085	1



## 1312 K1

### Timing tool set for OPEL

- DIESEL engines: 1.5 D, 2.0 DTi (chain), 2.0 D TURBO, 2.2 DTi (chain), 2.2 D, 3.0 D TURBO, 3.1 D TURBO

kg	code	
3	U13120085	1



### 1313 K2

#### Timing tool set for CITROEN/PEUGEOT

- PETROL (belt): 1.0, 1.1, 1.4, 1.6, 1.6 VTS, 1.8 16V, 2.0, 2.0 16V, 2.2

Kg	code	
1,9	U13130086	1



### 1315 K2

#### Timing tool set for AUDI/VW/SEAT/SKODA

- PETROL (belt) engines: 1.4 16V, 1.4 FSI, 1.6-1.6 16V-1.6 FSI  
- DIESEL (belt) engines: 1.7 D, 1.7 SDI, 1.9 D, 1.9 TDI, 1.9 SDI, 1.9 D TURBO, 2.5 TDI (6 cyl rotating pump)

Kg	code	
2,3	U13150086	1



### 1315 K5

#### Timing tool set for VW/SEAT/SKODA

- PETROL (belt): 1.0, 1.0 BlueMotion Technology, 1.0 EcoFuel, 1.0 Ecomotive, 1.0 GreenTech, 1.0 MPI

Kg	code	
1,4	U13150089	1



### 1313 K3

#### Timing tool set for CITROEN/PEUGEOT

- PETROL (belt): 1.0 VTi, 1.2 e-THP, 1.2 VTi, 1.2 e-VTi, 1.2 PureTech Vti

Kg	code	
1,3	U13130087	1



### 1315 K3

#### Timing tool set for AUDI/VW/SEAT/SKODA

- PETROL (chain) engines: 1.2 6V 3 cyl, 1.2 12V 3 cyl, 1.4 TSI, 1.4 FSI, 1.6 FSI

Kg	code	
2	U13150087	1



### 1344 K1

#### Timing tool set for ALFA/FIAT/LANCIA/OPEL/SUZUKI/FORD

- DIESEL (chain) engines: 1.3 Multijet, 1.3 CDTi, 1.3 TDCi, 1.3 JTD/Multijet

Kg	code	
1,4	U13440085	1



### 1315 K1

#### Timing tool set for AUDI/VW/SEAT/SKODA

- DIESEL (belt) engines: TDI PD 1.2-1.4-1.9-2.0, TDI CR 1.6-2.0, SDI 2.0

Kg	code	
1,8	U13150085	1



### 1315 K4

#### Timing tool set

- DIESEL (belt) engines: TDI PD 1.9-2.0 with oval pulley

Kg	code	
0,3	U13150088	1



### 1344 K2

#### Timing tool set for: ALFA/FIAT/LANCIA/OPEL

- DIESEL (belt) engines: 1.6 JTDM 16V, 1.6 Multijet, 1.9 Multijet, 1.9 CDTi (Z19), 1.9 JTD, 1.9 JTD/Multijet, 2.0 JTDM 16V, 2.0 Multijet, 2.4 JTD

Kg	code	
1	U13440086	1



### 1344 K3

#### Timing tool set for FIAT/ALFA

- PETROL engines: 0.9 TwinAir, 1.4 MultiAir



kg	code	
1,7	U13440087	1



### 1344 K6

#### Timing tool set for FIAT 1.6 16V

- PETROL (belt) engines: 1.6, 1.6 16V, 1.6 Bipower, 1.6 Bipower CNG, 1.6 Bipower/Natural Power CNG, 1.6 LPG



kg	code	
2	U13440090	1



### 1344 K4

#### Timing set for FIAT/ALFA/LANCIA/FORD

- PETROL (belt) engines: 1.2, 1.2 Easy Power LPG, 1.2 GPL, 1.2 Bi-Fuel GPL, 1.2 8V, 1.2 ECO, 1.2 Dualogic, 1.2 Natural Power CNG, 1.2 Bipower/Natural Power, 1.4, 1.4 8V, 1.4 Bi-Fuel GPL, 1.4 Natural Power CNG



kg	code	
1,7	U13440088	1



### 1510 N

#### Cooling system tester

- Checks cooling system tightness (hoses, clips, pump, radiator, cylinder-head gasket)  
- Supplied in plastic case with pump, pressure gauge and screw cups



LxPxH mm	kg	code	
445x335x95	2,1	U15100081	1



### 1344 K5

#### Timing tool set for FIAT 1.2-1.4 16V

- PETROL (belt) engines: 1.2 16V, 1.4 16V, 1.4 Abarth, 1.4 Abarth LE/Esseesse, 1.4 Bi-Fuel LPG, 1.4 LPG Turbo, 1.4 T-Jet, 1.4 T-Jet 120, 1.4 T-Jet 120 LPG, 1.4 T-Jet 120 Natural Power, 1.4 T-Jet 150, 1.4 Turbo 120, 1.4 Turbo 120 LPG, 1.6, 1.6 16V, 1.6 Bipower, 1.6 Bipower CNG, 1.6 Bipower/Natural Power CNG, 1.6 LPG



kg	code	
1,6	U13440089	1



### 1612 A CE

#### Memory saver 12 and 24V

- For use with 12V and 24V batteries  
- Prevents the loss of data of electronic accessories when replacing the battery or when there is a temporary cut in the vehicle current  
- Protected against short circuit and reverse polarity  
- Operating display with 2 LEDs  
- Compact and shock-resistant structure



gr	code	
150	U16120005	1



### 1612 BA12 CE

#### Central unit protector 12V

- For use with 12V batteries  
- Protects the control unit during welding operations or when starting with a charger, booster or cables  
- Protected against short circuit  
- Operating display with LED  
- Compact and shock-resistant structure



gr	code	
150	U16120006	1



### 1612 BA24 CE

#### Central unit protector 24V

- For use with 24V batteries  
- Protects the control unit during welding operations or when starting with a charger, booster or cables  
- Protected against short circuit  
- Operating display with LED  
- Compact and shock-resistant structure



gr	code	
150	U16120007	1



## 1613 RA12 CE



### Professional start booster 12 V, portable

- For intensive professional use
- Emergency starter suitable for 12V motorcycles, cars, vans and commercial vehicles
- Long cables (155 cm) that allow the use of the starter from the ground
- Integrated transformer: no external power supply
- High performance pure lead AGM battery
- LED indicator of the charge status of the starter's internal battery
- To check the state of charge of the vehicle battery, connect the cables and press the TEST button (Red: battery to be recharged/replaced immediately; Yellow: Battery almost empty; Green: Battery full)
- External fuse: overcurrent protection up to 300A
- Straight clamps
- Shockproof ABS shell
- Also suitable for sealed batteries
- Supplied with mins charger (for optimal charging, it is recommended to connect the power plug to a direct power source; avoid multiple sockets)

characteristics	size
Working voltage (V)	12
Working current (A)	1200
Starting current (A)	3500
Pliers amperage (A)	1000
Tensione di ricarica (V)	220-240V AC
Cable length (cm)	155
Cable diameter (mm <sup>2</sup> )	21,5
Battery type (supplied)	1 x AGM 12V

LxPxH mm	kg	code	
400x115x320	10	U16130019	1



## 1613 OBD

### OBD memory saver 12 V

- Works connected to a 12V starter through a cigarette lighter connection
- Can be connected to the vehicle through an OBD connector (input diagnosis)
- Compatible with all E-OBD and OBD-II connections
- Connecting it inside the car allows to work comfortably with the vehicle on the car lift
- Integrated protection fuse
- ATTENTION: use this accessory only with 12V boosters

L m	code	
2	U16130003	1



## 1613 AGM12-24 CE

### Professional start booster 12-24 V, portable

- For emergency starting, as battery charger and as an additional energy source for vehicles (save memories) and for 12V or 24V electrical equipments
- Ideal for cars, vans, trucks, boats, vehicles agricultural, generators etc.
- Voltmeter to indicate the charge status of the internal battery
- Rear connector for voltage selection
- External fuse: overcurrent protection up to 300A
- Shockproof ABS shell
- Overvoltage protection
- Also suitable for sealed batteries
- Inclined clamps
- Supplied with mains charger and cigarette lighter cable

characteristics	size
Working voltage (V)	12-24
Starting current 12V (A)	3700
Starting current 24V (A)	1860
Working current 12V (A)	1400
Working current 24V (A)	700
Charging voltage (V)	220-240V AC
Cable length (cm)	155
Cable diameter (mm <sup>2</sup> )	35
Battery type (supplied)	2 x AGM 12V

LxPxH mm	kg	code	
560x590x200	20,8	U16130013	1



## 1620 A CE

### Glow plug tester

- For use with 12V batteries
- It allows a fast and accurate testing of glow plugs
- Possibility to test for each glow plug
- Suitable for all types of glow plugs from 3.5 to 12 Volt
- Suitable for steel and ceramic glow plugs
- Protected against short circuit and reverse polarity
- Compact and shock-resistant structure

kg	code	
150	U16200001	1



## 1651 CE

### Digital infrared thermometer

- For measuring the temperature at distance
- Integrated laser pointer
- LCD backlighting display
- Memory functions
- Automatic power-off after 1 minute of inactivity
- Emissivity regulation
- Indication of maximum, minimum and average temperature detected
- Setting of the maximum temperature to detect, with luminous warning when detected
- Setting of the minimum temperature to detect, with luminous warning when a lower value has been reached
- Compatible with thermocouple K (not included)
- Not suitable for body temperature detection
- Supplied with rubber protective pouch

characteristics	size
Measuring range (°C/°F)	-60÷625°C - 76÷1157°F
Resolution	0,1°C / 0,1°F
Precision	+/- 2%
Emissivity	adjustable 0,1÷1
Optical report (D:S)	16:1
Display	LCD backlighting
Power supply (V)	2 batteries AAA

kg	code	
250	U16510001	1



## 1785 A

### Vacuum/pressure pump

- Capacity: -1÷4 bar
  - Vacuum/pressure selection valve
  - Aluminium body
  - 800 mm flexible hose
  - 30 adapters included
  - Tray for liquids included
  - Vacuum: 0 ÷ -1 bar
  - Pressure: 0 ÷ 4 bar
  - Fluid suction (diesel, brake fluid, cooling fluid, ecc.)
- USE
- Vacuum advance with a timing light
  - Vacuum advance with AEI Renix ignition
  - Seal for fuel supply system
  - Working on carburetor valves
  - Seal for brake power assistance
  - Turbine exhaust control membranes
  - Supplied in plastic case

kg	code	
1,2	U17850003	1





## 1785 B

### Fluid extractor

- For the extraction of lubricating oil from engine, brakes, gearbox and antifreeze fluids from any type of vehicle
- It allows a fast and easy replacement of brake fluid on the vehicle directly
- Use: manually using a lever or pneumatic with compressed air
- Compact dimensions and light weight to be used in many sectors: Automotive, Industrial, Marine and Aeronautical
- It allows fast and safe operations even outside the workshop
- Tank and polypropylene structure for high resistance to oils
- Vacuum valve located on the upper side
- Possibility to check the amount of fluid extracted by side marker
- The vacuum inside the tank decreases when the maximum level is reached
- Integrated carrying handle
- Supplied with 4 suction tubes with different diameters and lengths 400xØ 9,5 mm, 700xØ 6 mm, 850xØ 7 mm, 700xØ 6 mm
- Equipped with tube long 150 cm, Ø 16 mm, for the coupling of 4 suction tubes
- Supplied with instruction manual
- Spare tube, long 150 cm Ø 16 mm: code 1004730-69
- Spare tube, long 400 mm Ø 9,5 mm: code 1004730-65
- Spare tube blue, long 700 mm Ø 6 mm: code 1004730-66
- Spare tube black, long 850 mm Ø 7 mm: code 1004730-67
- Spare nylon tube long 700 mm Ø 6 mm: code 1004730-68

characteristics	size
Recommended air pressure (bar)	5÷8
Temperature aspirated liquids range (°C)	1÷100
Tank capacity (l)	9,5

LxPxH mm	kg	code	
230x302x627	4,1	U17850005	1



## 1881 S22

### Set of 22 wrenches for assembling and disassembling the nuts of alternators pulleys

- Set for assembling and disassembling the freewheel pulleys, to change alternator and pulley
- It allows to loose and fix the central pulley nut and, at the same time, to block shaft
- The various combinations allow to avoid disassembling additional components such as the radiator

kg	code	
1,3	U18810082	1



## 1950 C

### Pair of jack stands

- Adjustable height with toothed mechanism and lever release
- Locking pin with chain
- 1950 C/3: model adjustable in 10 positions
- 1950 C/6: model adjustable in 13 positions

power max ton	h max mm	h min mm	axb mm	code	
3	427	300	207x188	U19501001	1
6	620	400	285x250	U19501002	1



## 1951 B

### Bottle jacks

- Compact and robust structure
- Wide base for exceptional stability in all working positions
- Equipped with adjustable extension screw with safety stop
- Automatic end of stroke valve
- All models are supplied with the appropriate command handle

power max ton	h max mm	h min mm	kg	code	
2	355	173	2	U19512000	1
5	423	200	3,5	U19512001	1
12	447	220	6	U19512002	1



## 2000 A

### Inspection creeper

- Headrest in vinyl resistant to hydrocarbons, padded with high resistance foam rubber
- Plastic body resistant to hydrocarbons, washable
- Two side trays for tools
- Handle
- Maximum loading capacity: 150 kg
- Maximum height from ground 115 mm
- Supplied with 6 swivelling rubber casters Ø 80 mm (not assembled)

LxPxH mm	kg	code	
1030x480x115	4,6	U20000100	1



## 2000 G

### Kneeling pad

- Suitable material to withstand repeated use
- Carrying handle
- Dimensions suitable for resting on both knees
- Possibility to store it inside our roller cabinet drawer

LxPxH mm	kg	code	
475x290x50	230	U20000110	1



## 2550 A CE

### Hydraulic service jack 3t for cars and commercial vehicles

- Steel structure
- Versatile and compact for use in narrow spaces
- High capacity for use on cars, SUVs and vans
- Dual pump system to lift the car faster
- Equipped with manual descent control
- Air bleed valve, to avoid risk of over-load
- Handle with rubber bumper
- Polyurethane wheels
- Rubber disk: code DL.32A-10
- Front wheels (2 pieces): code DL.32A-1
- Rear wheels (2 pieces): code DL.32A-9

characteristics	size
Capacity (t)	3
Max lifting height (mm)	465
Min lifting height (mm)	133

LxP mm	kg	code	
615x344	30,5	U25500001	1



## 2550 B CE

### Hydraulic service jack 2t

- Steel structure
- Versatile and compact for use in narrow spaces
- Dual pump system to lift the car faster
- Equipped with lifting pedal
- Equipped with manual descent control
- Air bleed valve, to avoid risk of over-load
- Handle with rubber bumper
- Polyurethane wheels
- Rubber disk: code DL.32A-10
- Front wheels (2 pieces): code DL.2LP-1
- Rear wheels (2 pieces): code DL.32A-9

characteristics	size
Capacity (t)	2
Max lifting height (mm)	505
Min lifting height (mm)	75

LxP mm	kg	code	
762x350	32,5	U25500002	1



## 2800 S21

### Kit with 21 tools for brake pistons

- Moves front and rear brake pistons back by pushing and turning operations
- It allows to easily reposition the brake pistons into the pliers seat
- It includes 2 spindles with left and right rotation and several plates, adapters and accessories
- Compatible with the following car models: CITROEN, AUDI, FIAT / ALFA ROMEO, FORD, ISUZU, HONDA, JAGUAR, BMW, MERCEDES, MITSUBISHI, NISSAN, ROVER, TOYOTA, VOLVO, VOLKSWAGEN, MAZDA, SAAB, GM, SUBARU, PEUGEOT, RENAULT, MINI, OPEL
- Supplied in plastic case

LxPxH mm	kg	code	
320x50x250	2,6	U28000085	1



## 2847/3

### Brake bleeder

- For changing, filling and bleeding the circuit of brakes on cars and industrial vehicles
- Device designed exclusively for brake fluids DOT 3, DOT 4, DOT 5.1. No LHM.
- Adjustable pressure up to 4 bar
- Automatic stop at 10% of the tank (1 L)
- Power supply 12 V with crocodile clips
- Rear accessory housing
- Integrated wheels and handle for easy transport
- Operating liquid system: peristaltic pump (no direct pump/liquid contact, no air pressure on liquid)
- Supplied with spare gaskets, 1 multi-diameter cap 44-45-46 mm (2847 N11) and tank for oil recovery

characteristics	size
Power supply (V)	12
Pressure limiting device (bar)	4
Tank capacity (l)	10
Elastic spiral hose (m)	4
Power cable (m)	4

code	
U28470084	1



NEW

## 2847 N1

### Cap adapter for TOYOTA-LEXUS

- For brake bleeder 2847/2 and 2847/3

code	
U28470095Q	1



NEW



## 2847 N2

### Cap adapter for HONDA

- For brake bleeder 2847/2 and 2847/3

code	
U28470096Q	1



NEW



## 2847 N3

### Cap adapter for NISSAN

- For brake bleeder 2847/2 and 2847/3

code	
U28470097Q	1



## 2847 N4

### Universal plug

- For brake bleeder 2847/2 and 2847/3

capacity ø min-max mm	kg	code	
26÷92	450	U28470098Q	1

## 2847 N5

### Cap adapter for FORD-MAZDA

- For brake bleeder 2847/2 and 2847/3

code	
U28470099Q	1

## 2847 N6

### Cap adapter for CHRYSLER-JEEP

- For brake bleeder 2847/2 and 2847/3

code	
U28470100Q	1

## 2847 N7

### 2847 N7: Cap adapter for MITSUBISHI L200

- For brake bleeder 2847/2 and 2847/3

code	
U28470101Q	1



NEW



### 2847 N8

#### Kit of adapters for cap brake fluid reservoir

- Drilling the cap of the brake fluid reservoir and inserting the appropriate adapter, it will be possible to bleed the brake circuits with bleeder 2847/2 or 2847/3

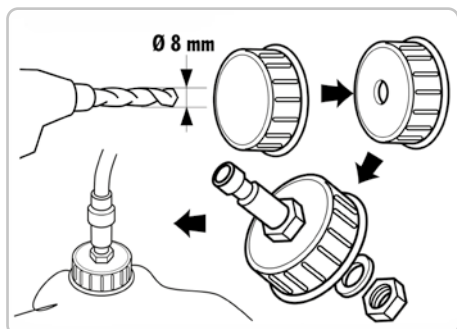

code	
U28470102Q	1



NEW

### 2847 A

#### Vacuum brake bleeder

- To bleed fluid for hydraulic brakes and clutches
- Working pressure 6-10 bar
- Tank capacity 3 litres
- Air connection 1/4"
- Equipped with pressure gauge (with rubber protection) that shows the vacuum value
- Suction rubber tube with Ø 0,9 cm and total length 105 cm (7 cm of the connector included)

gr	LxP mm	code	
980	318x180	U28470086	1



NEW

### 2847 B

#### Spare connector

- Vacuum brake bleeder 2847 A

code	
U28470087	1



### 3500 S1P

EN ISO 20345:2011

#### Safety shoes with highly breathable upper

- Category S1P
- Low shoe in Mesh with overprinted microfiber
- 100% polyester lining with honeycomb processing to improve the air recycling for good perspiration
- Lightweight and resistant composite toecap
- Removable preformed insole, in two-colours and bi-density polyurethane, air circulating, washable and antibacterial. It offers excellent comfort and cushioning
- Bi-density polyurethane sole resistant to bending and abrasion, anti-oil, non-slip
- Comfortable anti-perforation midsole
- Fit 12
- 100% metal free
- Recommended use: light work, mechanical industry, logistics / packaging

EU	code	
36	U35000036	1
37	U35000037	1
38	U35000038	1
39	U35000039	1
40	U35000040	1
41	U35000041	1
42	U35000042	1
43	U35000043	1
44	U35000044	1
45	U35000045	1
46	U35000046	1
47	U35000047	1



### 3781 C

#### Paper floor mats

- Moquette-cover in blotting paper
- Dimensions: 45x35 cm
- Pack with 250 pieces

code	
U38000073	1



### 3781 D

#### Steering wheel cover

- To protect steering wheel in workshops
- Stretchable film
- Complete with unroll device in plastics
- Pack with 5 coils

code	
U38000074	1



### 3781 A

#### Workshop set service

- Composed by:
  - 1 display stand,
  - 1 coil of 250 seat covers,
  - 250 paper floor mats,
  - 1 coil of steering wheel cover+handgrip

code	
U38000072	1



### 3781 E

#### Seat Covers

- Polyethylene
- Double format, covers completely the seat, including the rear part
- Thickness: 13 micron
- Dimensions: 70x165 cm
- Coil of 250 pieces

code	
U38000075	1

# EASY TO COMPOSE

All the elements of **Matrix** range are multiples of these modules:

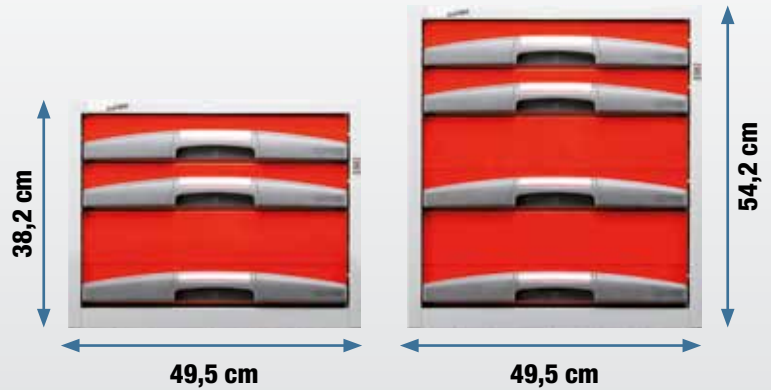

**MATRIX's modularity** makes possible to combine wheel-bases, drawer chests and shelves with simple and visible rules. That's why **Matrix** easily fits to all needs and vans.



**1**

Every lay-out starts with the **WHEEL-BASES** available in 8 models, suitable for all types of vans

**2**

The **MODULES** are the heart of Matrix: available in 29 variants designed with different sizes and combinations of drawers

**3**

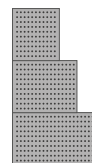

**SHELVES** are to be placed on top of bases or drawer chests and have 3 different depths to best follow the van's shape

**4**

A wide range of **ACCESSORIES** allows to complete the lay-out



## COMMERCIAL VEHICLES LAY-OUT

# EASY TO DESIGN

WITH THE CONFIGURATOR YOU CAN EQUIP  
YOUR VAN AS YOU WANT!



Go to our site  
**[www.usag-tools.net](http://www.usag-tools.net)**  
to try it or frame the  
QR code

**1**

### SIMPLE AND INTUITIVE

Place the modules  
as you like inside  
your van

**2**

### IT WORKS ONLINE

No installation required;  
compatible with the most  
popular browsers

**3**

### PROJECT IN A CLICK

Save your project and export it to  
PDF or Excel to get a quote from  
your Reseller

**If you want, we can check your project for free:**

Send the excel, Pdf, or .mtx files saved with the configurator at our address **[matrix@mygts.net](mailto:matrix@mygts.net)**.

# EASY TO ASSEMBLE

WITH THE NEW FIXING SYSTEM

## 5002 S5

Code U50020048

- 1 Steel fixing bar**
  - Dimensions:  
L2300 x P32 xH32 mm.
- 2 U-brackets and hardware for fixing included**

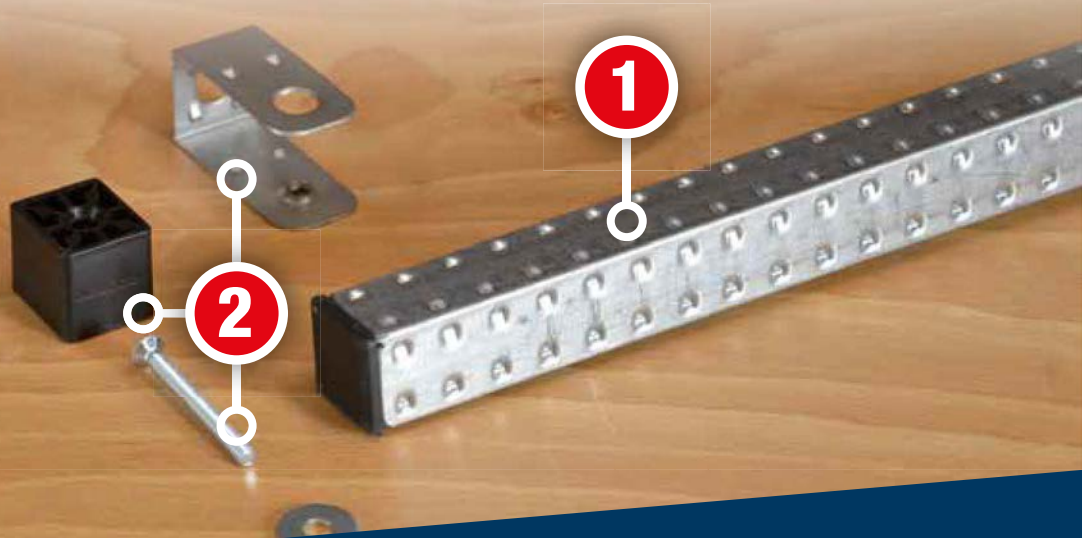

**Save assembly costs:  
you can do the setup yourself!**



**Watch the tutorial for the assembly on USAG  
YouTube channel or scan the QR code**



## YOUR LAY-OUT STEP BY STEP:



### PROJECT YOUR LAY-OUT

with the online planner you can design the lay-out that best fits to your needs



### EXPORT YOUR PROJECT

Save the project on your device in excel, Pdf or .mtx format



### WOULD YOU CHECK YOUR PROJECT?

You can ask USAG directly to verify it by sending an excel, Pdf, or .mtx file to: [matrix@mygts.net](mailto:matrix@mygts.net)



### CONTACT USAG RESELLER

For your order, please contact your USAG Reseller



### WATCH THE ASSEMBLING INSTRUCTIONS

On USAG **YouTube** channel you can find the video tutorials that show you how to do it. **Now you can set up your van!**

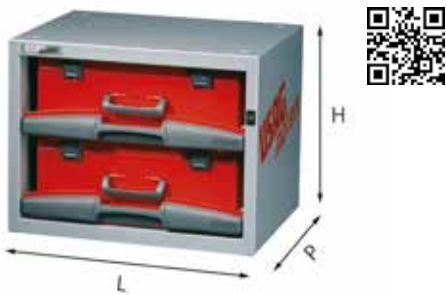

### 5000 A2

#### Composition with removable boxes

- Drawer chest with 2 boxes 5000 H2
- Supplied with fixing bracket 5002 S4N (U50020047)
- Spare slides: code U49806048
- Spare lock: code U05360001Q

LxPxH mm	kg	code	
495x375x382	17	U50000001	1



### 5000 AD2

#### Composition for plastic cases

- It can contain two boxes for energized tools
- Closing with tilting bar
- Supplied with fixing bracket 5002 S4N (U50020047)



LxPxH mm	kg	code	
495x375x382	6	U50000004	1



### 5000 B5

#### Composition with removable boxes

- Drawer chest with 4 boxes 5000 H1 and 1 box 5000 H2
- Supplied with fixing bracket 5002 S4N (U50020047)
- Spare slides: code U49806048
- Spare lock: code U05360001Q

LxPxH mm	kg	code	
495x375x542	30	U50000024	1

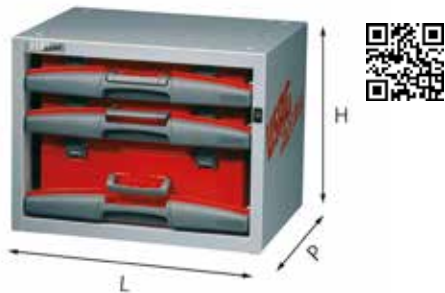

### 5000 A3

#### Composition with removable boxes

- Drawer chest with 2 boxes 5000 H1 and 1 box 5000 H2
- Supplied with fixing bracket 5002 S4N (U50020047)
- Spare slides: code U49806048
- Spare lock: code U05360001Q

LxPxH mm	kg	code	
495x375x382	22	U50000002	1

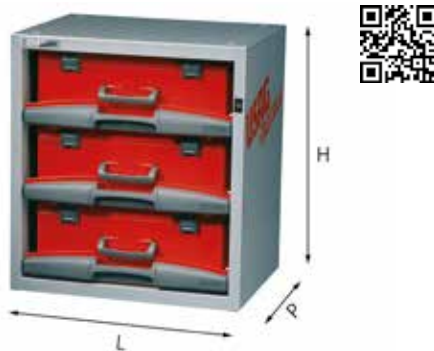

### 5000 B3

#### Composition with removable boxes

- Drawer chest with 3 boxes 5000 H2
- Supplied with fixing bracket 5002 S4N (U50020047)
- Spare slides: code U49806048
- Spare lock: code U05360001Q

LxPxH mm	kg	code	
495x375x542	24	U50000022	1

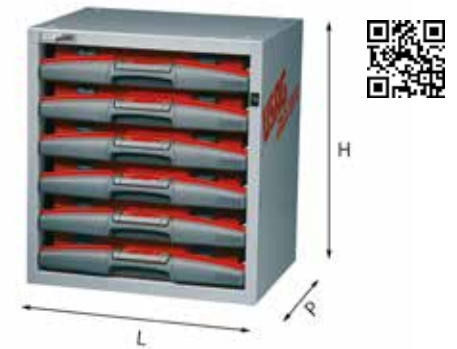

### 5000 B6

#### Composition with removable boxes

- Drawer chest with 6 boxes 5000 H1
- Supplied with fixing bracket 5002 S4N (U50020047)
- Spare slides: code U49806048
- Spare lock: code U05360001Q

LxPxH mm	kg	code	
495x375x542	37	U50000025	1

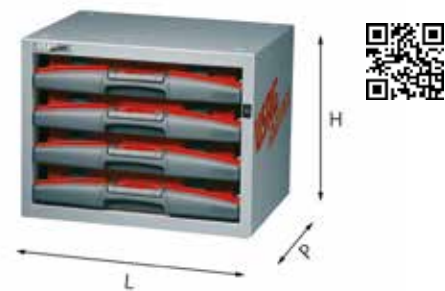

### 5000 A4

#### Composition with removable boxes

- Drawer chest with 4 boxes 5000 H1
- Supplied with fixing bracket 5002 S4N (U50020047)
- Spare slides: code U49806048
- Spare lock: code U05360001Q

LxPxH mm	kg	code	
495x375x382	25	U50000003	1

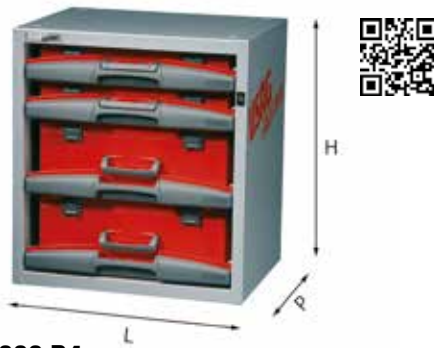

### 5000 B4

#### Composition with removable boxes

- Drawer chest with 2 boxes 5000 H1 and 2 boxes 5000 H2
- Supplied with fixing bracket 5002 S4N (U50020047)
- Spare slides: code U49806048
- Spare lock: code U05360001Q

LxPxH mm	kg	code	
495x375x542	29	U50000023	1



### 5000 BD2

#### Composition for plastic cases

- It can contain three boxes for energized tools
- Closing with tilting bar
- Supplied with fixing bracket 5002 S4N (U50020047)



LxPxH mm	kg	code	
495x372x542	8	U50000026	1



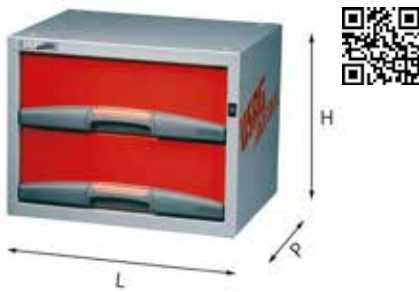

### 5000 C2

#### Composition with drawers

- Drawer chest with 2 drawers H 155 mm
- Supplied with fixing bracket 5002 S4N (U50020047)
- Spare slides: code U49806048
- Spare lock: code U05360001Q

LxPxH mm	Kg	code	
495x375x382	13	U50000041	1



### 5000 CE2

#### Composition with drawers

- Drawer chest with 2 drawers H 155 mm
- Supplied with fixing bracket 5002 S4N (U50020047)
- Spare lock: code U05360001Q

LxPxH mm	Kg	code	
742,5x375x382	22	U50000051	1

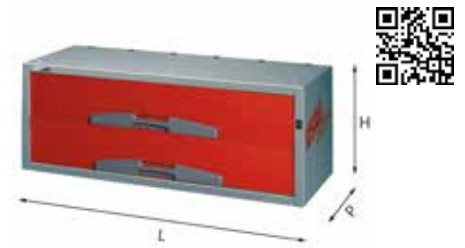

### 5000 CL2N

#### Composition with long drawers

- Drawer chest with 2 drawers H 155 mm
- Supplied with fixing bracket 5002 S4N (U50020047)
- Spare lock: code U05360001Q

LxPxH mm	Kg	code	
990x375x382	28	U50000084	1

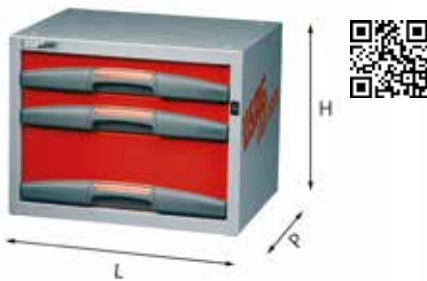

### 5000 C3

#### Composition with drawers

- Drawer chest with 2 drawers H 75 mm and 1 drawer H 155 mm
- Supplied with fixing bracket 5002 S4N (U50020047)
- Spare slides: code U49806048
- Spare lock: code U05360001Q

LxPxH mm	Kg	code	
495x375x382	16	U50000042	1

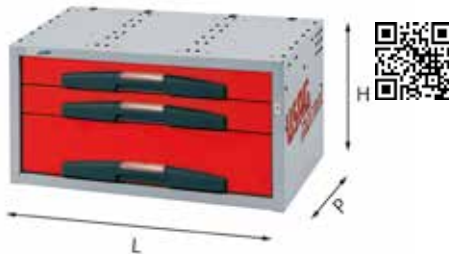

### 5000 CE3

#### Composition with drawers

- Drawer chest with 2 drawers H 75 mm and 1 drawer H 155 mm
- Supplied with fixing bracket 5002 S4N (U50020047)
- Spare lock: code U05360001Q

LxPxH mm	Kg	code	
742,5x375x382	26,5	U50000052	1



### 5000 CL3N

#### Drawer chest with long drawers

- Drawer chest with 2 drawers H 75 mm and 1 drawer H 155 mm
- Supplied with fixing bracket 5002 S4N (U50020047)
- Spare lock: code U05360001Q

LxPxH mm	Kg	code	
990x375x382	30	U50000085	1

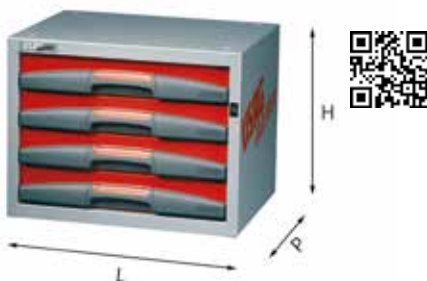

### 5000 C4

#### Composition with drawers

- Drawer chest with 4 drawers H 75 mm
- Supplied with fixing bracket 5002 S4N (U50020047)
- Spare slides: code U49806048
- Spare lock: code U05360001Q

LxPxH mm	Kg	code	
495x375x382	15	U50000043	1

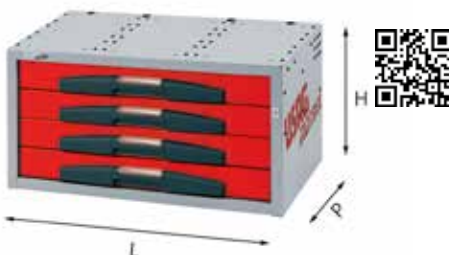

### 5000 CE4

#### Composition with drawers

- Drawer chest with 4 drawers H 75 mm
- Supplied with fixing bracket 5002 S4N (U50020047)
- Spare lock: code U05360001Q

LxPxH mm	Kg	code	
742,5x375x382	27,5	U50000053	1



### 5000 CL4N

#### Composition with long drawers

- Drawer chest with 4 drawers H 75 mm
- Supplied with fixing bracket 5002 S4N (U50020047)
- Spare lock: code U05360001Q

LxPxH mm	Kg	code	
990x375x382	32,5	U50000086	1

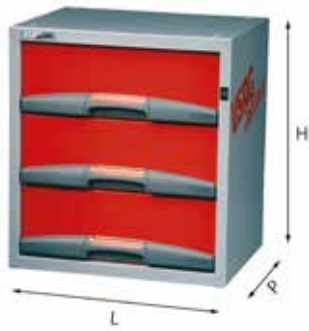

### 5000 D3

#### Composition with drawers

- Drawer chest with 3 drawers H 155 mm
- Supplied with fixing bracket 5002 S4N (U50020047)
- Spare slides: code U49806048
- Spare lock: code U05360001Q

LxPxH mm	kg	code	
495x375x542	19	U50000062	1

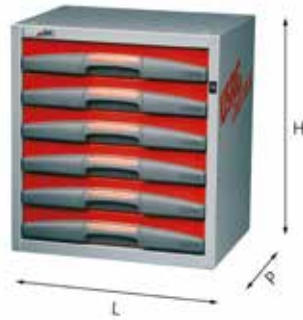

### 5000 D6

#### Composition with drawers

- Drawer chest with 6 drawers H 75 mm
- Supplied with fixing bracket 5002 S4N (U50020047)
- Spare slides: code U49806048
- Spare lock: code U05360001Q

LxPxH mm	kg	code	
495x375x542	24	U50000065	1

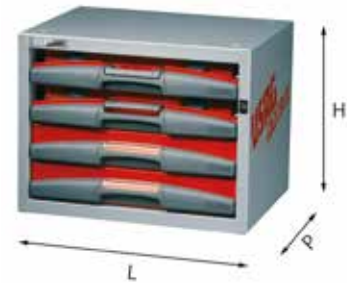

### 5000 E1

#### Composition with boxes and drawers

- Drawer chest with 2 boxes 5000 H1 and 2 drawers H 75 mm
- Supplied with fixing bracket 5002 S4N (U50020047)
- Spare slides: code U49806048
- Spare lock: code U05360001Q

LxPxH mm	kg	code	
495x375x382	21,5	U50000101	1



### 5000 D4

#### Composition with drawers

- Drawer chest with 2 drawers H 75 mm and 2 drawers H 155 mm
- Supplied with fixing bracket 5002 S4N (U50020047)
- Spare slides: code U49806048
- Spare lock: code U05360001Q

LxPxH mm	kg	code	
495x375x542	21	U50000063	1



### 5000 DE4

#### Composition with drawers

- Drawer chest with 2 drawers H 75 mm and 2 drawers H 155 mm
- Supplied with fixing bracket 5002 S4N (U50020047)
- Spare lock: code U05360001Q

LxPxH mm	kg	code	
742,5x375x542	30	U50000072	1



### 5000 E2

#### Composition with boxes and drawers

- Drawer chest with 3 boxes 5000 H1 and 1 drawer H 75 mm
- Supplied with fixing bracket 5002 S4N (U50020047)
- Spare slides: code U49806048
- Spare lock: code U05360001Q

LxPxH mm	kg	code	
495x375x382	21,3	U50000102	1



### 5000 D5

#### Composition with drawers

- Drawer chest with 4 drawers H 75 mm and 1 drawer H 155 mm
- Supplied with fixing bracket 5002 S4N (U50020047)
- Spare slides: code U49806048
- Spare lock: code U05360001Q

LxPxH mm	kg	code	
495x375x542	23	U50000064	1



### 5000 DE5

#### Composition with drawers

- Drawer chest with 4 drawers H 75 mm and 1 drawer H 155 mm
- Supplied with fixing bracket 5002 S4N (U50020047)
- Spare lock: code U05360001Q

LxPxH mm	kg	code	
742,5x375x542	32	U50000073	1



### 5000 E3

#### Composition with boxes and drawers

- Drawer chest with 2 boxes 5000 H1 and 1 drawer H 155 mm
- Supplied with fixing bracket 5002 S4N (U50020047)
- Spare slides: code U49806048
- Spare lock: code U05360001Q

LxPxH mm	kg	code	
495x375x382	19,2	U50000103	1



## 5000 E5

### Composition with boxes and drawers

- Drawer chest with 1 box 5000 H2 and 1 drawer H 155 mm
- Supplied with fixing bracket 5002 S4N (U50020047)
- Spare slides: code U49806048
- Spare lock: code U05360001Q

LxPxH mm	Kg	code	
495x375x382	16,3	U50000105	1

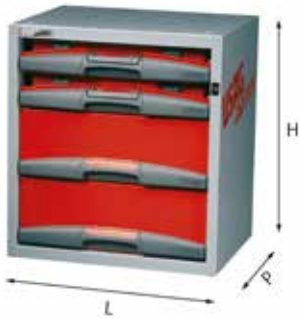

## 5000 F1

### Composition with boxes and drawers

- Drawer chest with 2 boxes 5000 H1 and 2 drawers H 155 mm
- Supplied with fixing bracket 5002 S4N (U50020047)
- Spare slides: code U49806048
- Spare lock: code U05360001Q

LxPxH mm	Kg	code	
495x375x542	25,4	U50000151	1

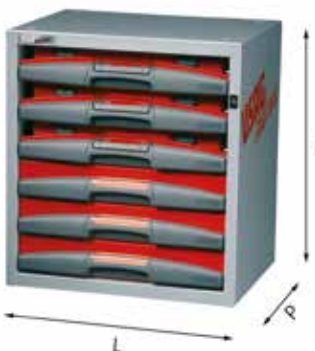

## 5000 F2

### Composition with boxes and drawers

- Drawer chest with 3 boxes 5000 H1 and 3 drawers H 75 mm
- Supplied with fixing bracket 5002 S4N (U50020047)
- Spare slides: code U49806048
- Spare lock: code U05360001Q

LxPxH mm	Kg	code	
495x375x542	28,8	U50000152	1

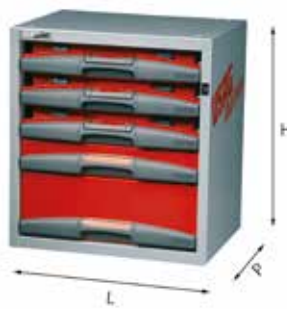

## 5000 F3

### Composition with boxes and drawers

- Drawer chest with 3 boxes 5000 H1, 1 drawer H 75 mm and 1 drawer H 155 mm
- Supplied with fixing bracket 5002 S4N (U50020047)
- Spare slides: code U49806048
- Spare lock: code U05360001Q

LxPxH mm	Kg	code	
495x375x542	28	U50000153	1



## 5000 H1

### Removable tool box

- Tool box arranged to fit the plastic trays 5003/8H - 5003 12H
- Clip lock and handle for transport
- Maximum load 5 Kg

LxPxH mm	Kg	code	
403x312x62	2,3	U50000301	1



## 5000 H2

### Removable tool box

- Tool box with clip lock and handle for transport
- Maximum load 12 Kg

LxPxH mm	Kg	code	
403x312x135	3	U50000302	1

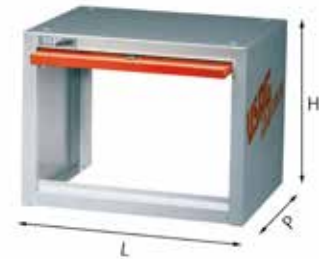

## 5002 A1N

### Base

- Open model for wheel-side
- Overhead door with security locking
- Inside available height 325 mm

LxPxH mm	Kg	code	
495x375x382	8,3	U50020003	1



## 5002 A2N

### Base

- Open model for wheel-side
- Overhead door with security locking
- Inside available height 325 mm

LxPxH mm	Kg	code	
990x375x382	15,2	U50020004	1



## 5002 A3

### Base

- Open model for wheel-side
- Overhead door with security locking
- Inside available height 325 mm

LxPxH mm	Kg	code	
1237,5x375x382	16	U50020005	1



## 5002 B1N

### Base

- Open model for wheel-side
- Overhead door with security locking
- Inside available height 480 mm

LxPxH mm	Kg	code	
495x375x542	13	U50020008	1



### 5002 B2N

#### Base

- Open model for wheel-side
- Overhead door with security locking
- Inside available height 480 mm

LxPxH mm	kg	code	
990x375x542	16	U50020009	1



### 5002 B3

#### Base

- Open model for wheel-side
- Overhead door with security locking
- Inside available height 480 mm

LxPxH mm	kg	code	
1237,5x375x542	17,5	U50020010	1



### 5002 C2N

#### Base

- Open model for SHAPED wheel-side
- Overhead door and security locking
- Inside available height 325 mm

LxPxH mm	kg	code	
990x375x382	15	U50020012	1



### 5002 D1N

#### Base

- Closed model
- Overhead door with security locking
- Inside available height 325 mm

LxPxH mm	kg	code	
495x375x382	10	U50020019	1



### 5002 D2N

#### Base

- Closed model
- Overhead door and security locking
- Inside available height 325 mm

LxPxH mm	kg	code	
990x375x382	20	U50020020	1



### 5002 D3N

#### Base

- Closed model
- Up-and-over door with security locking
- Inside available height 325 mm

LxPxH mm	kg	code	
1485x375x382	30	U50020021	1



### 5002 D4

#### Base

- Closed model
- Up-and-over door with security locking
- Inside available height 325 mm

LxPxH mm	kg	code	
742,5x375x382	15	U50020022	1

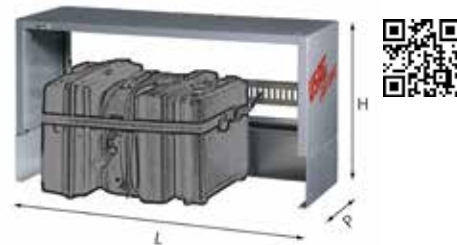

### 5002 E2

#### Case holder base

- Belt-type case holder
- Belt in syntetic anti-graze material
- Inside available dimensions L920xD340xH510 mm
- Supplied with case bar 5002 EB and belt 5002 EC

LxPxH mm	kg	code	
990x375x542	11,7	U50020024	1



### 5002 EB

#### Case bar

- Spare bar for case holder 5002 E2
- Can be used also with uprights 5003 MD-ME-MF
- Steel casing

L mm	a mm	kg	code	
930	130	1,8	U50020035Q	1



### 5002 EC

#### Belt

- Spare belt in syntetic anti-graze material
- For case holder 5002 E2
- Blocking clamp and steel hooks
- ATTENTION: NOT SUITABLE FOR LIFTING

L mm	gr	code	
2130	400	U50020036Q	1



### 5002 F1

#### Work-wear cabinet

- Steel structure
- Two doors with key locking
- Lower space for shoes
- Two upper spaces for clothes
- Hanging bar
- Dimensions (open) LxDxH 905x375-275x924 mm



LxPxH mm	kg	code	
495x375-275x924	11,7	U50020025	1



### 5002 R1

#### Shelf

- Model for modules 495 mm with 2 removable dividers
- Supplied with anti-slip rubber mat

LxPxH mm	kg	code	
495x375x90	4	U50020030	1



### 5002 R10

#### Shelf

- Extensible shelf for pipe storing

LxPxH mm	kg	code	
1650÷3100x300x90	20	U50020035	1



### 5002 R2

#### Shelf

- Model for modules 990 mm with 4 removable dividers
- Supplied with anti-slip rubber mat

LxPxH mm	kg	code	
990x375x90	8	U50020031	1



### 5002 R3

#### Shelf

- Model for modules 1485 mm with 6 removable dividers
- Supplied with anti-slip rubber mat

LxPxH mm	kg	code	
1485x375x90	11	U50020032	1



### 5002 RL1

#### Shelf

- Model for modules 742 mm with 4 removable dividers
- Supplied with anti-slip rubber mat

LxPxH mm	kg	code	
742,5x375x90	5	U50020033	1



### 5002 SA

#### Covering top in Zinc-plated sheet steel

- Thickness 2 mm
- Rear edges to prevent falls

n°	LxPxH mm	code	
7	990x390x40	U50020056	1
7L	1485x390x40	U50020057	1



### 5002 S1

#### Holder

- Bottle-holder (2 pcs.)
- Sheet steel casing
- Nylon belt with ratchet device

kg	code	
2	U50020045	1



### 5002 S2

#### Holder

- Cable-holder
- Completely in plastic material

LxPxH mm	gr	code	
260x160x150	250	U50020046	1



### 5002 S4N

#### Fixing bracket

- Steel thickness 2 mm

L mm	P mm	gr	code	
250	45	146	U50020047	1



### 5002 S5

#### Fixing bar

- Ensures strong and stable fixing of the modules
- Allows to fix the modules easily and quickly
- Suitable for all models of van
- Contents:
  - Square tubular section bar made of galvanized steel, thickness 1 mm (1 pc.)
  - Galvanized steel U-brackets 1 mm thick (9 pcs.)
  - Plastic spacers (9 pcs.)
  - Screws TSPEI M6x60 (4 pcs.)
  - Screws TSPEI M8x60 (5 pcs.)
  - Screws TBL M6x12 (8 pcs.)
  - Washers ø 8x24 (4 pcs.)
  - Washers ø 6x18 (5 pcs.)
  - Cage nuts M6 (5 pcs.)
  - Threaded inserts M6 (4 pcs.)
  - Galvanized steel brackets L 240 mm thickness 2,5 mm (5 pcs.)
  - Galvanized steel spacers thickness 2,5 mm (3 pcs.)
  - Plastic closure plugs (2 pcs.)

LxPxH mm	kg	code	
2300x32x32	4,1	U50020048	1



### 5002 S9

#### Inclined plan

- Sheet steel casing
- Security locking

LxPxH mm	kg	code	
495x375x250	7	U50020060	1



### 5002 S10

#### Wheel set for tool chests (2 pcs.)

- Composed by 2 fixing brackets, 4 swivelling wheels, 2 of which have a brake
- Rubber wheels ø 80mm

kg	code	
2	U50020061	1



### 5002 SA2

#### Document holder

LxPxH mm	kg	code	
360x50x262	0,8	U50020064	1



### 5002 SA4

#### Roll holder with paper cutter

L mm	H mm	kg	code	
360	265	1,1	U50020066	1



### 5002 SA5

#### Bottle-holder

LxPxH mm	kg	code	
360x70x135	0,6	U50020067	1



### 5002 SA6

#### Can for water with holder

- Capacity 10 liters with integrated tap
- Stopper of screwed shut

LxPxH mm	kg	code	
370x155x380	3	U50020131	1



### 5002 SA7

#### First aid plastic box with holder

Contents:

- Sterile gloves (2 pcs.)
- Bottle of cutaneous solution of iodine povi-iodone at 10% of iodine: 125 ml (1 pc)
- Bottle of physiological solution (sodium chloride 0,9%) : 250 ml (1 pc)
- Compressed of sterile bandage 18 x 40 in single envelopes (1 pc)
- Compressed of sterile bandage 10 x 10 in single envelopes (3 pcs)
- Sterile tweezers for medication (1 pc)
- Confection of cotton wool (1 pc)
- Confection of plasters of several measures ready to use (1 pc)
- Coil of plaster: cm 2,5 (1 pc)
- Coil of bandage: cm 10 (1 pc)
- Scissors (1 pc)
- Emostatic lace (1 pc)
- Confection of instant ice (1 pc)
- Bags for the collection of sanitary wastes (1 pc)
- Instructions on the way to use the aforesaid headmasters and lend the first aids waiting for emergency service

LxPxH mm	kg	code	
375x105x215	2,3	U50020132	1



### 5002 ZA2

#### Base

- Open model for wheel-side and vice assembly
- To be used in combination with worktop with vice 5002 ZM4
- Inside available height 500 mm

LxPxH mm	kg	code	
990x375x502	18	U50020070	1



### 5002 ZM2

#### Worktop with vice

- Sheet steel structure
- Sliding multilayer wooden plan with vice 498 B100

LxPxH mm	kg	code	
1310x375x40	23	U50020074	1

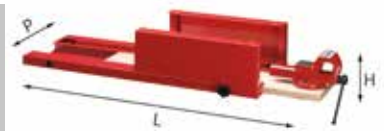

### 5002 ZM3

#### Worktop with vice

- Sheet steel structure
- Sliding multilayer wooden plan with vice 498 B100

LxPxH mm	kg	code	
990x375x200	20	U50020075	1



### 5002 ZM4

#### Worktop with vice

- Sheet steel structure
- Sliding multilayer wooden plan with vice 498 B100
- To be used in combination with base 5002 ZA2

LxPxH mm	kg	code	
990x375x40	18	U50020076	1



### 5002 ZM5

#### Foldaway worktop with vice

- Vice-holding sheet steel structure
- Hydraulic pistons to facilitate movements
- Supplied with vice 498 B100
- Possibility to equip with swivelling support 498 GE
- Can be fixed to the modules and to the floor panel or only to the vehicle floor
- Can also be used with the support for vice 5002 Z2
- Work plan in galvanized metal
- Dimensions (work plan) LxD 845x200 nmm
- Dimensions (closed) LxDxH 250x315x980 mm when closed



LxPxH mm	kg	code	
915x315x285	22	U50020078	1



## 5002 Z1

### Spacer

- To level the module heights on vice sides
- Sheet steel casing

LxPxH mm	kg	code	
495x375x40	3	U50020081	1

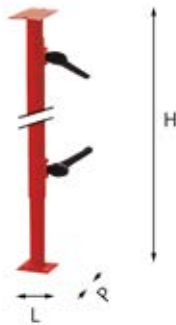

## 5002 Z2

### Vice holder

- Sheet steel tubular casing
- Max opening: 1080 mm
- To use in combination with worktops with vices 5002 ZM2, 5002 ZM3, 5002 ZM4, 5002 ZM5

LxPxH mm	kg	code	
70x110x710	4	U50020082	1

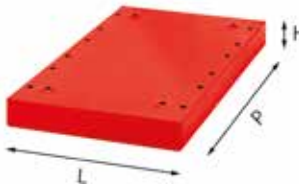

## 5002 Z3

### Spacer for vice holder

- To level the module heights on vice sides
- Sheet steel casing

LxPxH mm	kg	code	
247,5x375x40	1,5	U50020084	1



## 5003 A1

### Tray-holders

- Supplied with plastic trays 5003/1A
- To combine with the uprights of line 5003 MD

n° trays	LxPxH mm	kg	code	
5	682,5x200x90	2,9	U50030067	1
8	930x200x90	3,5	U50030068	1
10	1177,5x200x90	5	U50030069	1
12	1425x200x90	7,5	U50030070	1



## 5003 A2

### Tray-holders

- Supplied with plastic trays 5003/1B
- To combine with the uprights of line 5003 MF

n° trays	LxPxH mm	kg	code	
4	682,5x275x140	6	U50030072	1
5	930x275x140	7	U50030073	1
7	1177,5x275x140	9	U50030074	1
8	1425x275x140	10	U50030075	1



## 5003 A3

### Tray-holders

- Supplied with plastic trays 5003/1C
- To combine with the uprights of line 5003 ME

n° trays	LxPxH mm	kg	code	
3	682,5x3x375x175	5	U50030077	1
4	930x375x175	8	U50030078	1
5	1177,5x375x175	11	U50030079	1
6	1425x375x175	12	U50030080	1

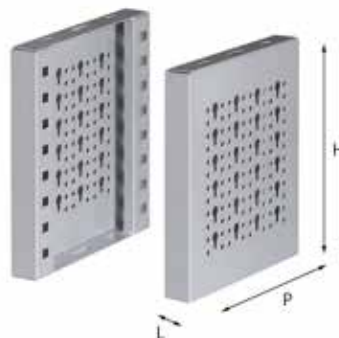

## 5003 MD

### Uprights 200 mm

- Two uprights for shelves 5003 RA-RAC-RAL-A1
- Side holes for hooks 552÷557
- Can be put on vehicle plans or on modules

n°	LxPxH mm	code	
1	30x200x222	U50030046	1
2	30x200x382	U50030047	1
3	30x200x542	U50030048	1

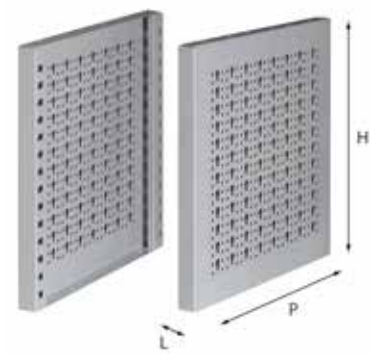

## 5003 ME

### Uprights 375 mm

- Two uprights for shelves 5003 RC-RCC-RIC-RICL-A3
- Side holes for hooks 552÷557
- Can be put on vehicle plans or on modules

n°	LxPxH mm	code	
1	30x375x222	U50030049	1
2	30x375x382	U50030050	1
3	30x375x542	U50030051	1

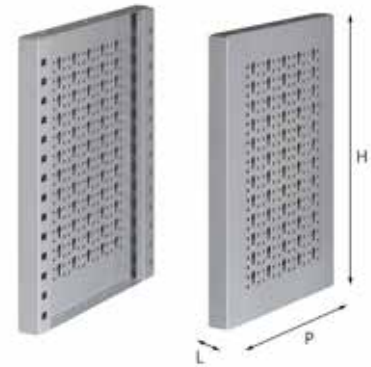

## 5003 MF

### Uprights 275 mm

- Two uprights for shelves 5003 RBC-RB-RBL-RIB-RIBL-A2
- Side holes for hooks 552÷557
- Can be put on vehicle plans or on modules

n°	LxPxH mm	code	
1	30x275x222	U50030052	1
2	30x275x382	U50030053	1
3	30x275x542	U50030054	1



## 5003 RAC1

### Shelf

- With 4 removable dividers
- To combine with the uprights of line 5003 MD
- Supplied with anti-slip rubber mat

LxPxH mm	kg	code	
682,5x200x90	3	U50030028	1



### 5003 RA1

#### Shelf

- Shelf with 4 removable dividers
- To combine with the uprights of line 5003 MD
- Supplied with anti-slip rubber mat

LxPxH mm	kg	code	
930x200x90	5,1	U50030024	1



### 5003 RAL1

#### Shelf

- With 5 removable dividers
- To combine with the uprights of line 5003 MD
- Supplied with anti-slip rubber mat

LxPxH mm	kg	code	
1177,5x200x90	6,5	U50030029	1



### 5003 RA2

#### Shelf

- Shelf with 6 removable dividers
- To combine with the uprights of line 5003 MD
- Supplied with anti-slip rubber mat

LxPxH mm	kg	code	
1425x200x90	7,4	U50030025	1



### 5003 RBC1

#### Shelf

- Shelf with 4 removable dividers
- To combine with the uprights of line 5003 MF
- Supplied with anti-slip rubber mat

LxPxH mm	kg	code	
682,5x275x90	5	U50030090	1



### 5003 RB1

#### Shelf

- Shelf with 4 removable dividers
- To combine with the uprights of line 5003 MF
- Supplied with anti-slip rubber mat

LxPxH mm	kg	code	
930x275x90	6	U50030026	1



### 5003 RBL1

#### Shelf

- Shelf with 5 removable dividers
- To combine with the uprights of line 5003 MF
- Supplied with anti-slip rubber mat

LxPxH mm	kg	code	
1177,5x275x90	6,5	U50030091	1



### 5003 RB2

#### Shelf

- Shelf with 6 removable dividers
- To combine with the uprights of line 5003 MF
- Supplied with anti-slip rubber mat

LxPxH mm	kg	code	
1425x275x90	7	U50030027	1



### 5003 RCC1

#### Shelf

- Shelf with 4 removable dividers
- To combine with the uprights of line 5003 ME
- Supplied with anti-slip rubber mat

LxPxH mm	kg	code	
682,5x375x90	4,5	U50030030	1



### 5003 RC1

#### Shelf

- Shelf with 4 removable dividers
- To combine with the uprights of line 5003 ME
- Supplied with anti-slip rubber mat

LxPxH mm	kg	code	
930x375x90	5	U50030031	1



### 5003 RC2

#### Shelf

- Shelf with 6 removable dividers
- To combine with the uprights of line 5003 ME
- Supplied with anti-slip rubber mat

LxPxH mm	kg	code	
1425x375x90	10,5	U50030032	1



### 5003 RC3

#### Shelf

- Shelf with 5 removable dividers
- To combine with the uprights of line 5003 ME
- Supplied with anti-slip rubber mat

LxPxH mm	kg	code	
1177,5x375x90	7	U50030033	1



### 5003 RIB1

#### Inclined shelf

- Inclined shelf with 2 removable dividers
- To combine with the uprights of line 5003 MF
- Supplied with anti-slip rubber mat

LxPxH mm	kg	code	
435x275x185	3	U50030036	1



### 5003 RIBL1

#### Inclined Shelf

- Inclined shelf with 4 removable dividers
- To combine with the uprights of line 5003 MF
- Supplied with anti-slip rubber mat

LxPxH mm	kg	code	
682,5x275x185	4,5	U50030039	1



### 5003 RIB2

#### Inclined shelf

- Inclined shelf with 4 removable dividers
- To combine with the uprights of line 5003 MF
- Supplied with anti-slip rubber mat

LxPxH mm	kg	code	
930x275x185	6,5	U50030037	1



### 5003 RIB3

#### Inclined shelf

- Inclined shelf with 6 removable dividers
- To combine with the uprights of line 5003 MF
- Supplied with anti-slip rubber mat

LxPxH mm	kg	code	
1425x275x185	9	U50030038	1





### 5003 RIC1

#### Inclined shelf

- Inclined shelf with 2 removable dividers
- To combine with the uprights of line 5003 ME
- Supplied with anti-slip rubber mat

LxPxH mm	kg	code	
435x375x185	3,5	U50030041	1



### 5003 RICL1

#### Shelf

- Inclined shelf with 4 movable dividers
- To combine with the uprights of line 5003 ME
- Supplied with anti-slip rubber mat

LxPxH mm	kg	code	
682,5x375x185	5	U50030044	1



### 5003 RIC2

#### Inclined shelf

- Inclined shelf with 4 removable dividers
- To combine with the uprights of line 5003 ME
- Supplied with anti-slip rubber mat

LxPxH mm	kg	code	
930x375x185	7,5	U50030042	1



### 5003 RIC3

#### Inclined shelf

- Inclined shelf with 6 removable dividers
- To combine with the uprights of line 5003 ME
- Supplied with anti-slip rubber mat

LxPxH mm	kg	code	
1425x375x185	10,5	U50030043	1



### 5003 RR

#### Shelves without dividers

- Supplied with anti-slip rubber mat
- 5003 RR/1 to combine with the uprights of line 5003 MD
- 5003 RR/2 to combine with the uprights of line 5003 MF
- 5003 RR/3 to combine with the uprights of line 5003 ME

n°	LxPxH mm	kg	code	
1	187,5x200x90	1	U50030085	1
2	187,5x275x90	1,3	U50030086	1
3	187,5x375x90	1,6	U50030087	1



### 5003/1A

#### Plastic tray

- Plastic tray for 5003 A1

LxPxH mm	gr	code	
115x165x75	86	U50030001Q	1



### 5003/1B

#### Plastic tray

- Plastic tray for 5003 A2

LxPxH mm	gr	code	
160x230x125	180	U50030002Q	1



### 5003/1C

#### Plastic tray

- Plastic tray for 5003 A3

LxPxH mm	gr	code	
220x340x165	412	U50030003Q	1

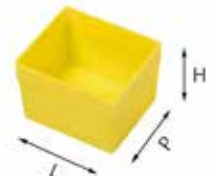

### 5003/2A

#### Plastic tray

- Plastic tray for tool boxes 5000 H1

LxPxH mm	gr	code	
65x75x52	22	U50030010Q	1

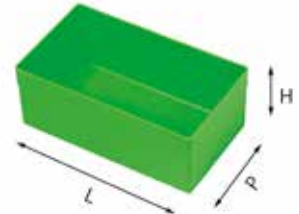

### 5003/2B

#### Plastic tray

- Plastic tray for tool boxes 5000 H1

LxPxH mm	gr	code	
129x75x52	38	U50030011Q	1

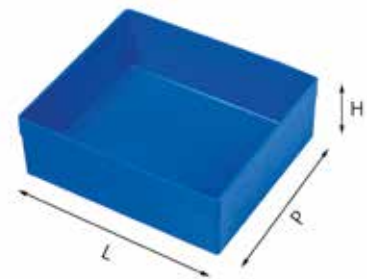

### 5003/2C

#### Plastic tray

- Plastic tray for tool boxes 5000 H1

LxPxH mm	gr	code	
148x129x52	70	U50030012Q	1

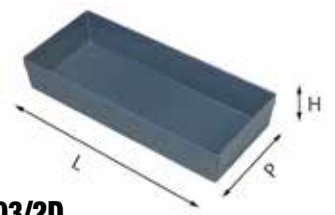

### 5003/2D

#### Plastic tray

- Plastic tray for tool boxes 5000 H1

LxPxH mm	gr	code	
297x129x52	118	U50030013Q	1



### 5003 HA 5

#### Assortment of plastic trays

- For tool boxes 5000 H1
- Composed by 4 plastic trays 5003/2C and 1 plastic tray 5003/2D

pcs	description	item/size
4	Plastic tray/148x128x51 mm	5003/2C
1	Plastic tray/296x128x51 mm	5003/2D

LxPxH mm	g	code	
384x296x51	398	U50030086Q	1



### 5003 HA 6

#### Assortment of plastic trays

- For tool boxes 5000 H1
- Composed by 6 plastic trays 5003/2C

pcs	description	item/size
6	Plastic tray/148x128x51 mm	5003/2C

LxPxH mm	g	code	
384x296x51	420	U50030087Q	1

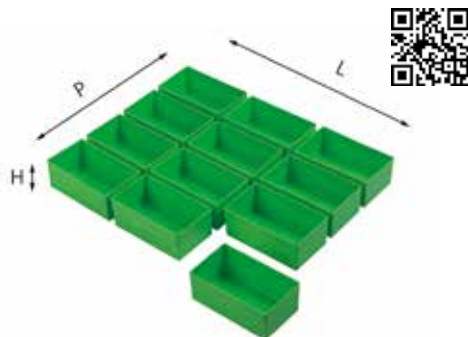

### 5003 HA 12

#### Assortment of plastic trays

- For tool boxes 5000 H1
- Composed by 12 plastic trays 5003/2B

pcs	description	item/size
12	Plastic tray/128x74x51 mm	5003/2B

LxPxH mm	g	code	
384x296x51	456	U50030089Q	1

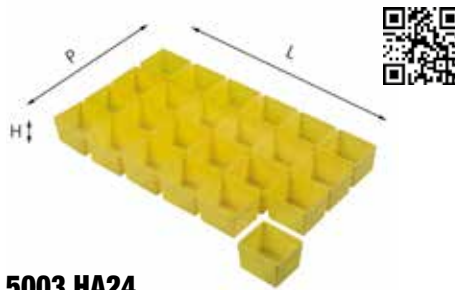

### 5003 HA 24

#### Assortment of plastic trays

- For tool boxes 5000 H1
- Composed by 24 plastic trays 5003/2A

pcs	description	item/size
24	Plastic tray/64x74x51 mm	5003/2A

LxPxH mm	g	code	
384x296x51	528	U50030091Q	1



### 5003/8H

#### Plastic tray

- For tool boxes 5000 H1
- Model with 8 compartments
- Not suitable for drawer chests 5000 CLN-CE-DE

LxPxH mm	g	code	
380x295x50	200	U50030025Q	1

### 5003/8

#### Plastic tray

- For drawers
- Model with 8 compartments
- Not suitable for drawer chests 5000 CLN-CE-DE

LxPxH mm	g	code	
400x315x50	260	U50030026Q	1



### 5003/12H

#### Plastic tray

- For tool boxes 5000 H1
- Model with 12 compartments
- Not suitable for drawer chests 5000 CLN-CE-DE

LxPxH mm	g	code	
380x295x50	200	U50030029Q	1

### 5003/12

#### Plastic tray

- For drawers
- Model with 12 compartments
- Not suitable for drawer chests 5000 CLN-CE-DE

LxPxH mm	g	code	
400x315x50	260	U50030030Q	1



### 5003/13H

#### Plastic tray

- For tool boxes 5000 H1
- Model with 13 compartments
- Not suitable for drawer chests 5000 CLN-CE-DE

LxPxH mm	g	code	
380x295x50	200	U50030031Q	1

### 5003/13

#### Plastic tray

- For drawers
- Model with 13 compartments
- Not suitable for drawer chests 5000 CLN-CE-DE

LxPxH mm	g	code	
400x315x50	260	U50030032Q	1



### 5003/18H

#### Plastic tray

- For tool boxes 5000 H1
- Model with 18 compartments
- Not suitable for drawer chests 5000 CLN-CE-DE

LxPxH mm	g	code	
380x295x50	200	U50030037Q	1

### 5003/18

#### Plastic tray

- For drawers
- Model with 18 compartments
- Not suitable for drawer chests 5000 CLN-CE-DE

LxPxH mm	g	code	
400x315x50	260	U50030038Q	1



### 5003/20H

#### Plastic tray

- For tool boxes 5000 H1
- Model with 20 compartments
- Not suitable for drawer chests 5000 CLN-CE-DE

LxPxH mm	g	code	
380x295x50	200	U50030041Q	1

### 5003/20

#### Plastic tray

- For drawers
- Model with 20 compartments
- Not suitable for drawer chests 5000 CLN-CE-DE

LxPxH mm	g	code	
400x315x50	260	U50030042Q	1



### 5003/150M

#### Assortment with pliers, hammers, and chisels (15 pcs.)

- For tool boxes 5000 C-D-E-F
- Only for drawers

pcs	description	item/size
1	Half-round extra-long nose pliers with straight jaws	133 AX/160
1	Combination pliers	150 AX/180
1	Semiautomatic adjustable pliers	180 B/250
1	Heavy-duty diagonal cutting nippers	188 AX/160
1	Scissors for electricians	207 A
1	Utility knife with snap-off blades	220 B1
1	Ribbed chisels	351/200
2	Chisels	362/125-150
1	Cross cut chisel	364/125
2	Drift punches/3x15 - 4x150	366
1	Centre punches	368/4x125
1	Hammers for mechanics	382/500
1	Pen-type LED torch in Aluminium - 170 Lumen	889 TM

LxPxH mm	kg	code	
400x315x45	2,7	U50031045	1



### 5003/285M

#### Assortment with wrenches (17 pcs.)

- For tool boxes 5000 C-D-E-F
- Only for drawers

pcs	description	item/size
12	Combination wrenches /7-8-9-10-11-12-13-14-17-19-22-24	285
4	Hinged jointed reversible ratchet combination wrenches/8-10-13-17	285 KF
1	Adjustable wrenches with quick adjustment	294 AD/250

LxPxH mm	kg	code	
400x315x45	2,1	U50031047	1



### 5003/324M

#### Assortment with screwdrivers and keys (28 pcs.)

- For tool boxes 5000 C-D-E-F
- Only for drawers

pcs	description	item/size
2	Screwdrivers for slot-head screws - 1000 V /0,6x3,5x100 - 0,8x4x100	091
1	Screwdrivers for PHILLIPS® screws - 1000 V/2x125	091 PH
1	Screwdrivers for POZIDRIV® - SUPADRIV® screws - 1000 V/2x125	091 PZ
9	Set of 9 long angled hexagon keys with spherical head/1,5-2-2,5-3-4-5-6-8-10	280 LTS/S9
8	Set of 8 long angled keys with spherical head for TORX® screws / T10-T15-T20-T25-T27-T30-T40-T45	280 LTSTX/S8
5	Screwdrivers for slot-head screws /0,4x2,5x50 - 0,5x3x75 - 0,8x4x100 - 1x5,5x125 - 1,2x6,5x150	324
3	Screwdrivers for PHILLIPS® screws / 0x75 - 1x75 - 2x100	324 PH

LxPxH mm	kg	code	
400x315x45	1,5	U50031049	1



### 5003/609M

#### Assortment with hexagonal sockets and accessories 1/4 - 1/2 (60 pcs.)

- Suitable for tool boxes 5000 H1

pcs	description	item/size
17	Hexagonal sockets / 8-10-11-12-13-14-15-16-17-18-19-21-22-24-27-30-32	235 1/2 EN
2	Extensions/125 -250	236 1/2
1	Reversible ratchet with sealed mechanism	237 B 1/2
1	T-handle with sliding square drive	240 1/2 N
1	Universal joint	241 1/2
1	Assortment with hexagonal sockets and bits 609 1/4 EB in bimaterial box (38 pcs.)	

LxPxH mm	kg	code	
380x300x45	4	U50031051	1

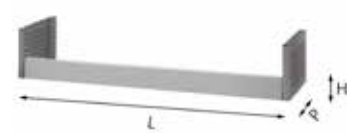

### 5003 S

#### Base for uprights

- For more rigidity when mounting shelving on the floor

n° trays	LxPxH mm	kg	code	
1	435x30x90	0,8	U50030101	1
2	682,5x30x90	1,1	U50030102	1
3	930x30x90	1,6	U50030103	1
4	1177,5x30x90	2	U50030104	1
5	1425x30x90	2,4	U50030105	1

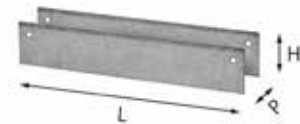

### 5003 SL

#### Dividers (2 pcs.)

- For drawer chests 5000 CE - DE - CLN
- Galvanized sheet steel

for drawers	LxPxH mm	kg	code	
H= 75 mm	305x2x60	0,5	U50030082Q	1
H= 155 mm	305x2x113	1	U50030083Q	1

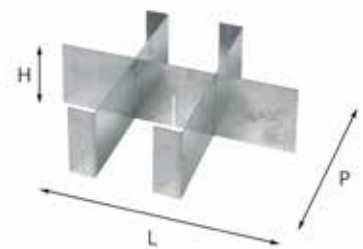

### 5003 S60

#### Dividers

- Zinc plated sheet steel dividers (3 pcs.)
- For drawers with height 75 mm
- Not suitable for drawer chests 5000 CLN - CE - DE

LxPxH mm	kg	code	
400x317x60	0,8	U50030080Q	1

### 5003 S120

#### Dividers

- Zinc plated sheet steel dividers (3 pcs.)
- For drawers with height 155 mm
- Not suitable for drawer chests 5000 CLN-CE-DE

LxPxH mm	kg	code	
400x317x120	1,6	U50030081Q	1



## POLYETHYLENE FOAMS FOR TOOL STORAGE

- Two-colours foam, black with red background
- Quick check of missing tools
- Tools blocked during transport
- No vibration and noise
- Dimensions suitable for standard drawers and boxes
- Density 33 Kg/m³



If you want to check the correct combination of the platform with the van, send us the vehicle registration document at the following address [matrix@mygts.net](mailto:matrix@mygts.net)



### 5005 C/CIT

#### Multilayer platforms with anti-slip phenolic coating

- Thickness 9 mm
- Made with holes for retaining hooks and hole metal covers
- Pre-drilled Aluminum profiles for rear and side door
- Maximum charge 14 quintals / m<sup>2</sup> with distributed load



n°	vehicle model	wheelbase	code	
6	JUMPY XS	2925	U50050205	1
7	JUMPY M	3275	U50050206	1
8	JUMPY L	3275 L	U50050207	1
9	JUMPER L1	3000	U50050208	1
10	JUMPER L2	3450	U50050209	1
11	JUMPER L3	4035	U50050210	1
12	JUMPER L4	4035 L	U50050211	1
13	BERLINGO L1	2785	U50050212	1
14	BERLINGO L2	2975	U50050213	1

### 5005 C/FIA



n°	vehicle model	wheelbase	code	
1	FIORINO	2513	U50050220	1
2	DOBLO' L1	2755	U50050221	1
3	DOBLO' L2	3105	U50050222	1
8	DUCATO L1	3000	U50050227	1
9	DUCATO L2	3450	U50050228	1
10	DUCATO L3	4035	U50050229	1
11	DUCATO L4	4035 L	U50050230	1
12	SCUDO	2925	U50050231	1
13	SCUDO	3275	U50050232	1
14	SCUDO	3275L	U50050233	1

### 5005 C/FOR



n°	vehicle model	wheelbase	code	
1	COURIER L1	2489	U50050380	1
2	CONNECT L1	2662	U50050381	1
3	CONNECT L2	3062	U50050382	1
4	CUSTOM L1	2933	U50050383	1
5	CUSTOM L2	3300	U50050384	1
6	TRANSIT L2	3300	U50050385	1
7	TRANSIT L3	3750	U50050386	1
8	TRANSIT L4	3750L	U50050387	1

### 5005 C/VE



n°	vehicle model	wheelbase	code	
1	DAILY	3000	U50050260	1
2	DAILY	3520	U50050261	1
3	DAILY	3520 L	U50050262	1
4	DAILY	4100	U50050263	1
5	DAILY	4100 L	U50050264	1

### 5005 C/MER



n°	vehicle model	wheelbase	code	
1	VITO COMPACT	3200	U50050270	1
2	VITO LONG	3200 XL	U50050271	1
3	VITO EXTRALONG	3430	U50050272	1
8	SPRINTER COMPACT	3250	U50050277	1
9	SPRINTER STANDARD	3665	U50050278	1
10	SPRINTER LONG	4325	U50050279	1
11	SPRINTER EXTRALONG	4325 L	U50050280	1

### 5005 C/NIS



n°	vehicle model	wheelbase	code	
1	NV 200	2725	U50050290	1
2	NV 300 L1	3098	U50050291	1
3	NV 300 L2	3498	U50050292	1
4	NV 400 L1	3182	U50050293	1
5	NV 400 L2	3682	U50050294	1
6	NV 400 L3	4332	U50050295	1
7	NV 400 L4	4332 L	U50050296	1

### 5005 C/OPE



n°	vehicle model	wheelbase	code	
5	MOVANO L1	3182	U50050304	1
6	MOVANO L2	3682	U50050305	1
7	MOVANO L3	4332	U50050306	1
8	MOVANO L4	4332 L	U50050307	1
9	COMBO	2785	U50050308	1
10	COMBO	2975	U50050309	1
11	VIVARO	2925	U50050310	1
12	VIVARO	3725	U50050311	1
13	VIVARO	3725L	U50050312	1

### 5005 C/PEU



n°	vehicle model	wheelbase	code	
6	EXPERT COMPACT	2925	U50050325	1
7	EXPERT STANDARD	3275	U50050326	1
8	EXPERT LONG	3275 L	U50050327	1
9	BOXER L1	3000	U50050328	1
10	BOXER L2	3450	U50050329	1
11	BOXER L3	4035	U50050330	1
12	BOXER L4	4035 L	U50050331	1
13	PARTNER L1	2785	U50050332	1
14	PARTNER L2	2975	U50050333	1

### 5005 C/REN



n°	vehicle model	wheelbase	code	
1	KANGOO COMPACT	2313 without side door	U50050340	1
2	KANGOO	2697	U50050341	1
3	KANGOO MAXI	3081	U50050342	1
4	TRAFIC L1	3098	U50050343	1
5	TRAFIC L2	3498	U50050344	1
6	MASTER L1	3182	U50050345	1
7	MASTER L2	3682	U50050346	1
8	MASTER L3	4332	U50050347	1
9	MASTER L4	4332 L	U50050348	1
10	KANGOO	2716	U50050349	1
11	KANGOO	2812	U50050350	1

### 5005 C/WV



n°	vehicle model	wheelbase	code	
1	CADDY L1	2682	U50050360	1
2	CADDY L2	3006	U50050361	1
3	TRANSPORTER L1	3000	U50050362	1
4	TRANSPORTER L2	3400	U50050363	1
9	CRAFTER L3	3640	U50050368	1
10	CRAFTER L4	4490	U50050369	1



### 5006 A4

#### Assortment for right side

pcs	description	item/size
1	Drawer chest with long drawers	5000 CL3N
1	Base	5002 B2N
1	Holder	5002 S1
1	Covering top in Zinc-plated sheet steel	5002 SA7L

LxPxH mm	Kg	code	
990x375x954	56	U50060007	1



### 5006 A6

#### Assortment for left side

pcs	description	item/size
1	Composition with removable boxes	5000 A3
1	Composition with drawers	5000 C3
1	Composition with boxes and drawers	5000 E5
1	Composition with boxes and drawers	5000 F3
1	Base	5002 B2N
1	Spacer	5002 Z1
1	Vice holder	5002 Z2
1	Worktop with vice	5002 ZM2
1	Uprights 375 mm	5003 ME/3
2	Inclined shelf	5003 RIC3

LxPxH mm	Kg	code	
1785x375x1506	165	U50060009	1



### 5006 C2

#### Assortment for left side

pcs	description	item/size
1	Composition with removable boxes	5000 A2
1	Composition with long drawers	5000 CL2N
1	Composition with drawers	5000 D3
1	Base	5002 B2N
3	Fixing bracket	5002 S4N
1	Roll holder with paper cutter	5002 SA4
1	Bottle-holder	5002 SA5
1	Uprights 375 mm	5003 ME/2
2	Shelf	5003 RC2

LxPxH mm	Kg	code	
1485x375x1306	126	U50060014	1

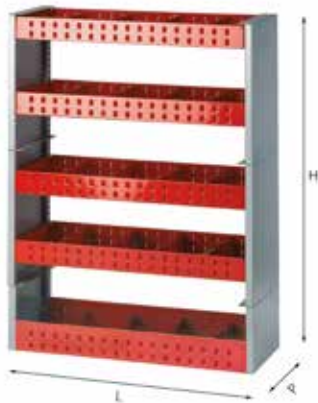

### 5006 A5

#### Assortment for front side

pcs	description	item/size
1	Uprights 375 mm	5003 ME/1
2	Uprights 275 mm	5003 MF/3
3	Shelf	5003 RB1
2	Shelf	5003 RC1

LxPxH mm	Kg	code	
990x375-275x1306	53	U50060008	1



### 5006 C1

#### Assortment for left side

pcs	description	item/size
1	Composition with removable boxes	5000 B4
1	Composition with drawers	5000 D3
1	Base	5002 B2N
2	Fixing bracket	5002 S4N
1	Roll holder with paper cutter	5002 SA4
1	Tray-holders	5003 A3/4
1	Uprights 375 mm	5003 ME/1

LxPxH mm	Kg	code	
990x375x1306	76	U50060013	1



### 5006 C3

#### Assortment for left side

pcs	description	item/size
1	Composition with drawers	5000 CE3
1	Composition with boxes and drawers	5000 E5
1	Base	5002 B3
3	Fixing bracket	5002 S4N
1	Bottle-holder	5002 SA5
1	Tray-holders	5003 A2
1	Uprights 275 mm	5003 MF

LxPxH mm	Kg	code	
1238x375x1146	96	U50060015	1



## 5006 C4

### Assortment for left side

pcs	description	item/size
1	Composition with drawers	5000 CE3
1	Drawer chest with long drawers	5000 CL3N
1	Composition with drawers	5000 D4
1	Base	5002 B3
4	Fixing bracket	5002 S4N
1	Roll holder with paper cutter	5002 SA4
1	Bottle-holder	5002 SA5
2	Uprights 375 mm	5003 ME/1
2	Uprights 275 mm	5003 MF/2
2	Shelf	5003 RB1
2	Shelf	5003 RBC1
1	Shelf	5003 RC1
1	Shelf	5003 RCC1

LxPxH mm	kg	code	
1732,5x375x1528	165	U50060016	1



## 5006 D1

### Assortment for left side

pcs	description	item/size
1	Composition with removable boxes	5000 B5
1	Composition with drawers	5000 D4
1	Base	5002 C2N
1	Shelf	5002 R2
1	Roll holder with paper cutter	5002 SA4

LxPxH mm	kg	code	
990x375x1014	74	U50060018	1



## 5006 E2

### Assortment for left side

pcs	description	item/size
2	Composition with drawers	5000 D3
1	Composition with drawers	5000 D5
1	Composition with boxes and drawers	5000 F3
1	Base	5002 B2N
1	Document holder	5002 SA2
1	Bottle-holder	5002 SA5
4	Tray-holders	5003 A2/5
2	Tray-holders	5003 A3/4
1	Uprights 375 mm	5003 ME/3
2	Uprights 375 mm	5003 ME/1
2	Uprights 275 mm	5003 MF/2
2	Inclined shelf	5003 RIC2

LxPxH mm	kg	code	
1980x375x1688	174,6	U50060020	1



## 5006 C5

### Assortment for left side

pcs	description	item/size
2	Composition with drawers	5000 C3
1	Composition with drawers	5000 CE3
1	Base	5002 B2N
4	Fixing bracket	5002 S4N
1	Bottle-holder	5002 SA5
1	Uprights 375 mm	5003 ME/3
2	Uprights 275 mm	5003 MF/2
2	Shelf	5003 RB1
2	Shelf	5003 RBC1
2	Shelf	5003 RCC1

LxPxH mm	kg	code	
1732,5x375x1306	132	U50060017	1



## 5006 E1

### Assortment for right side

pcs	description	item/size
2	Composition with drawers	5000 C3
1	Composition with drawers	5000 D3
1	Composition with boxes and drawers	5000 E1
1	Base	5002 B2N
1	Uprights 200 mm	5003 MD/1
1	Uprights 375 mm	5003 ME/2
1	Shelf	5003 RB2
1	Shelf	5003 RC2
1	Inclined shelf	5003 RIC3

LxPxH mm	kg	code	
1485x375x1528	121,4	U50060019	1



## 5006 E3

### Assortment for front side

pcs	description	item/size
1	Drawer chest with long drawers	5000 CL3N
1	Composition with drawers	5000 D4
1	Composition with drawers	5000 D5
1	Holder	5002 S1
1	First aid plastic box with holder	5002 SA7
1	Covering top in Zinc-plated sheet steel	5002 SA7L

LxPxH mm	kg	code	
990x375x954	89,3	U50060021	1



### 5006 E4

#### Assortment for right side

pcs	description	item/size
1	Composition with drawers	5000 C2
1	Composition with drawers	5000 C3
1	Base	5002 B2N
2	Tray-holders	5003 A2/5
1	Uprights 275 mm	5003 MF/2

LxPxH mm	Kg	code	img
990x375x1306	59	U50060022	1



### 5006 E6

#### Assortment for front side

pcs	description	item/size
2	Uprights 200 mm	5003 MD/3
1	Uprights 375 mm	5003 ME/1
3	Shelf	5003 RB1
2	Shelf	5003 RC1

LxPxH mm	Kg	code	img
990x375-275x1306	42,7	U50060024	1



### 5006 E8

#### Assortment for left side

pcs	description	item/size
1	Composition with removable boxes	5000 A3
2	Composition with drawers	5000 C3
1	Drawer chest with long drawers	5000 CL3N
1	Composition with drawers	5000 D3
1	Composition with boxes and drawers	5000 E3
1	Base	5002 B2N
1	Shelf	5002 R3
1	Holder	5002 S2
1	Document holder	5002 SA2

LxPxH mm	Kg	code	img
1485x375x1396	143	U50060026	1



### 5006 E5

#### Assortment for left side

pcs	description	item/size
1	Composition with removable boxes	5000 A3
1	Composition with drawers	5000 D3
1	Composition with drawers	5000 D4
1	Composition with boxes and drawers	5000 F3
1	Base	5002 B2N
1	Shelf	5002 R3
1	Document holder	5002 SA2
1	Spacer	5002 Z1
1	Vice holder	5002 Z2
1	Worktop with vice	5002 ZM3

LxPxH mm	Kg	code	img
1485x375x1214	143	U50060023	1



### 5006 E7

#### Assortment for right side

pcs	description	item/size
1	Composition with drawers	5000 C2
1	Composition with drawers	5000 C3
1	Base	5002 B2N
1	Uprights 200 mm	5003 MD/2
1	Uprights 375 mm	5003 ME/2
1	Shelf	5003 RA1
1	Inclined shelf	5003 RIB2
2	Inclined shelf	5003 RIC2

LxPxH mm	Kg	code	img
990x375x1688	80	U50060025	1



### 5006 E9

#### Assortment for right side

pcs	description	item/size
1	Composition with drawers	5000 D4
1	Composition with drawers	5000 D5
1	Base	5002 B2N
1	Roll holder with paper cutter	5002 SA4
1	Bottle-holder	5002 SA5
1	Tray-holders	5003 A2/5
1	Tray-holders	5003 A3/4
1	Uprights 200 mm	5003 MD/1
1	Uprights 375 mm	5003 ME/1
1	Uprights 275 mm	5003 MF/1
1	Shelf	5003 RB1

LxPxH mm	Kg	code	img
990x375x1750	85,7	U50060027	1

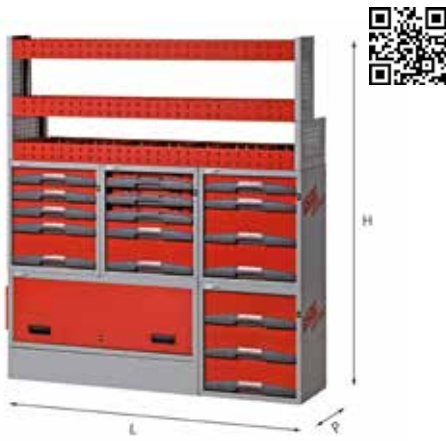

### 5006 E10

#### Assortment for left side

pcs	description	item/size
1	Composition with drawers	5000 D3
1	Composition with drawers	5000 D4
1	Composition with drawers	5000 D5
1	Composition with boxes and drawers	5000 F3
1	Base	5002 B2N
1	Document holder	5002 SA2
1	Uprights 200 mm	5003 MD/2
1	Uprights 375 mm	5003 ME/1
2	Shelf	5003 RB2
1	Shelf	5003 RC2

LxPxH mm	Kg	code	
1485x375x1688	140,4	U50060028	1

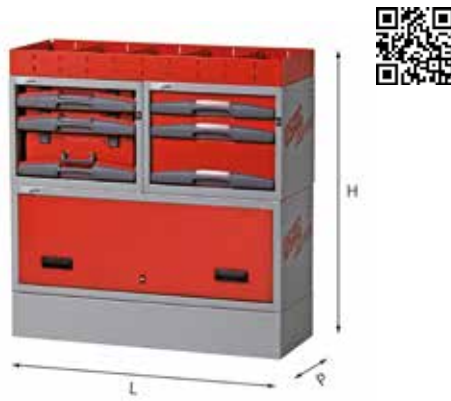

### 5006 E12

#### Assortment for left side

pcs	description	item/size
1	Composition with removable boxes	5000 A3
1	Composition with drawers	5000 C3
1	Base	5002 B2N
1	Shelf	5002 R2

LxPxH mm	Kg	code	
990x375x1014	59	U50060030	1



### 5006 E14

#### Assortment for right side

pcs	description	item/size
1	Base	5002 A2N
1	Uprights 200 mm	5003 MD/2
1	Uprights 375 mm	5003 ME/2
1	Shelf	5003 RA1
1	Inclined shelf	5003 RIB2
2	Inclined shelf	5003 RIC2

LxPxH mm	Kg	code	
990x375x1146	50	U50060032	1



### 5006 E11

#### Assortment for right side

pcs	description	item/size
1	Composition with drawers	5000 C4
1	Composition with boxes and drawers	5000 E1
1	Base	5002 B2N
1	Tray-holders	5003 A2/5
1	Uprights 275 mm	5003 MF/1

LxPxH mm	Kg	code	
990x375x1146	59,6	U50060029	1

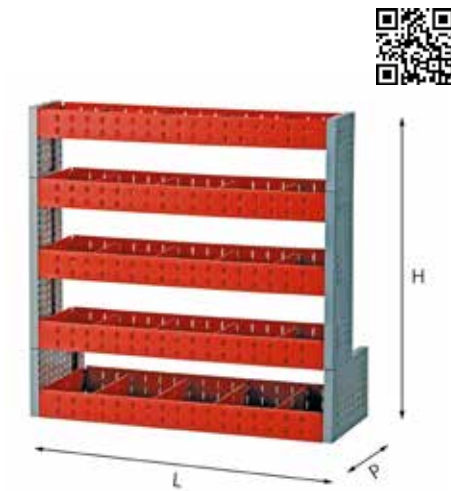

### 5006 E13

#### Assortment for front side

pcs	description	item/size
1	Uprights 200 mm	5003 MD/1
1	Uprights 200 mm	5003 MD/3
1	Uprights 375 mm	5003 ME/1
4	Shelf	5003 RB1
1	Shelf	5003 RC1

LxPxH mm	Kg	code	
990x375-275x986	40,3	U50060031	1

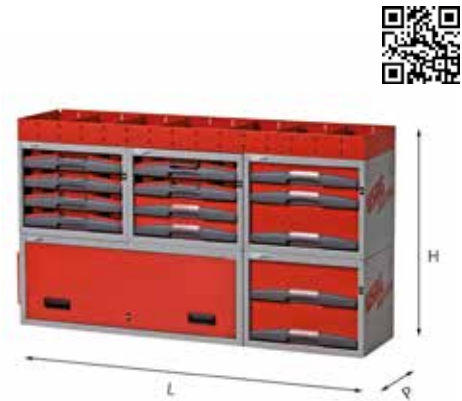

### 5006 E15

#### Assortment for left side

pcs	description	item/size
1	Composition with removable boxes	5000 A4
1	Composition with drawers	5000 C2
1	Composition with drawers	5000 C3
1	Composition with boxes and drawers	5000 E1
1	Base	5002 A2N
1	Shelf	5002 R3
1	Document holder	5002 SA2

LxPxH mm	Kg	code	
1485x375x854	95	U50060033	1





### 5006 EF1

#### Assortment for right or left side

pcs	description	item/size
1	Composition with removable boxes	5000 B4
1	Composition with drawers	5000 D3
1	Base	5002 B2N
1	Fixing bar	5002 S5
1	Roll holder with paper cutter	5002 SA4
1	Tray-holders	5003 A3/4
1	Uprights 375 mm	5003 ME/1

LxPxH mm	Kg	code	1
990x375x1306	76	U50060034	1

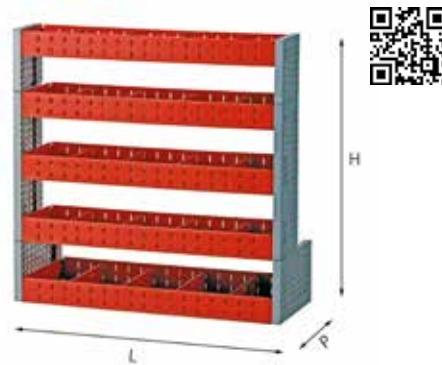

### 5006 EF3

#### Assortment for front side

pcs	description	item/size
1	Fixing bar	5002 S5
1	Uprights 200 mm	5003 MD/3
1	Uprights 200 mm	5003 MD/1
1	Uprights 375 mm	5003 ME/1
1	Shelf	5003 RB1
4	Shelf	5003 RC1

LxPxH mm	Kg	code	1
990x375x986	40	U50060036	1

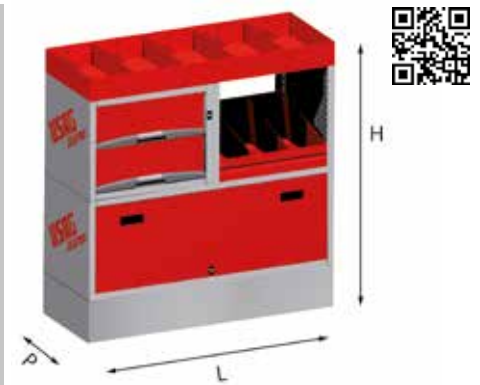

### 5006 EF5

#### Assortment for left side

pcs	description	item/size
1	Composition with drawers	5000 C2
1	Base	5002 B2N
1	Shelf	5002 R2
1	Fixing bar	5002 S5
1	Uprights 375 mm	5003 ME/2
1	Inclined shelf	5003 RIC1

LxPxH mm	Kg	code	1
990x375x1014	44	U50060039	1



### 5006 EF2

#### Assortment for left side

pcs	description	item/size
1	Composition with drawers	5000 CE3
1	Composition with boxes and drawers	5000 E5
1	Base	5002 B3
2	Fixing bar	5002 S5
1	Bottle-holder	5002 SA5
1	Tray-holders	5003 A2/7
1	Uprights 275 mm	5003 MF/1

LxPxH mm	Kg	code	1
1238x375x1146	96	U50060035	1

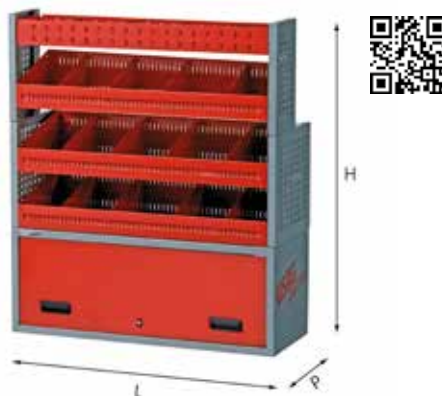

### 5006 EF4

#### Assortment for right or left side

pcs	description	item/size
1	Base	5002 A2N
1	Fixing bar	5002 S5
1	Uprights 200 mm	5003 MD/2
1	Uprights 375 mm	5003 ME/2
1	Shelf	5003 RA1
1	Inclined shelf	5003 RIB2
2	Inclined shelf	5003 RIC2

LxPxH mm	Kg	code	1
990x375x1146	50	U50060037	1



### 5006 EF6

#### Assortment for left side

pcs	description	item/size
1	Composition with drawers	5000 C3
1	Base	5002 B2N
1	Shelf	5002 R2
1	Fixing bar	5002 S5
1	Bottle-holder	5002 SA5
1	Composition for plastic cases	5000 AD2

LxPxH mm	Kg	code	1
990x375x1014	43	U50060040	1



# RMD

Professional line of modular drawer chests for industrial and commercial lay-out.

On-demand products:  
please contact your distributor



## RMD 280/1

### Modular drawer units

- Model with 5 drawers h 140 mm
- Telescopic slides
- Structure: fair grey (similar to RAL 7042), drawers dark grey (similar to RAL 7022)

version	LxPxH mm	kg	code	
AT	667x722x960	97	U10204378	1



## RMD 280/2

### Modular drawer units

- Model with 6 drawers h 60 mm and 2 drawers h 140
- Telescopic slides
- Structure: fair grey (similar to RAL 7042), drawers dark grey (similar to RAL 7022)

version	LxPxH mm	kg	code	
AT	667x722x960	121	U10204379	1



## RMD 280/3

### Modular drawer units

- Model with 10 drawers h 60 mm
- Telescopic slides
- Structure: fair grey (similar to RAL 7042), drawers dark grey (similar to RAL 7022)

version	LxPxH mm	kg	code	
AT	667x722x960	137	U10204380	1



## RMD 280/4

### Modular drawer units

- Model with 1 drawer h 60 mm and 6 drawers h 100 mm
- Telescopic slides
- Structure: fair grey (similar to RAL 7042), drawers dark grey (similar to RAL 7022)

version	LxPxH mm	kg	code	
AT	667x722x960	113	U10204381	1



## RMD 280/5

### Modular drawer units

- Model with 2 drawers h 60 mm, 4 drawers h 100 mm and 1 drawer h 140 mm
- Telescopic slides
- Structure: fair grey (similar to RAL 7042), drawers dark grey (similar to RAL 7022)

version	LxPxH mm	kg	code	
AT	667x722x960	113	U10204382	1



## RMD 280/6

### Modular drawer units

- Model with 3 drawers h 60 mm, 2 drawers h 100 mm and 2 drawers h 140 mm
- Telescopic slides
- Structure: fair grey (similar to RAL 7042), drawers dark grey (similar to RAL 7022)

version	LxPxH mm	kg	code	
AT	667x722x960	113	U10204383	1



## RMD 280/7

### Modular drawer units

- Model with 5 drawers h 60 mm, 2 drawers h 100 mm and 1 drawer h 140 mm
- Telescopic slides
- Structure: fair grey (similar to RAL 7042), drawers dark grey (similar to RAL 7022)

version	LxPxH mm	kg	code	
AT	667x722x960	121	U10204384	1

## 3U (2 pcs.)

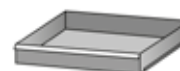

## RMD CA H100

### Drawers

- Telescopic slides
- Dark grey (similar to RAL 7022)

version	LxPxH mm	kg	code	
AT	555x555x120	11	U10204351	1

## 2U

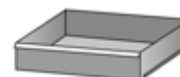

## RMD CA H140

### Drawers

- Telescopic slides
- Dark grey (similar to RAL 7022)

version	LxPxH mm	kg	code	
AT	555x555x160	12	U10204352	1

## 3U

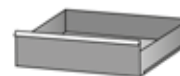

## RMD CA H222

### Drawers

- Telescopic slides
- Dark grey (similar to RAL 7022)

version	LxPxH mm	kg	code	
AT	555x555x240	13	U10204353	1

## 4U



## RMD CA H303

### Drawers

- Telescopic slides
- Dark grey (similar to RAL 7022)

version	LxPxH mm	kg	code	
AT	555x555x320	14	U10204354	1



## RMD 280 RPA

### Shelf

- Dark grey (similar to RAL 7022)

LxPxH mm	kg	code	
598x580x30	4	U10204388	1



## RMD 280 FA

### Cabinet with doors

- Upper drawer dimensions L555xD550xH60 mm  
- Structure: fair grey (similar to RAL 7042), drawers dark grey (similar to RAL 7022)

LxPxH mm	kg	code	
667x722x960	59	U10204387	1

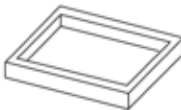

## RMD 280 ZA

### Baseboard

- Fair grey (similar to RAL 7042)

LxPxH mm	kg	code	
667x670x82	5	U10204343	1



## RMD TOP F

### Top

- Ribbed rubber mat  
- For models RMD 280  
- Depth 722 mm

L mm	capacity mm	code	
2000	2	U10211148	1

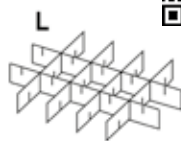
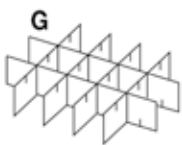

## RMD 200

### Cross-type dividers

- For drawers 555x555 mm  
- Composed by 6 pieces

version	H mm	code	
G	120	U10211021	1
L	100	U10211022	1

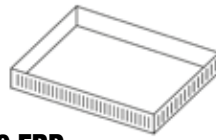

## RMD 200 FRP

### Outside supports

- For drawers 555x555 mm

H mm	code	
56	U10211280	1
96	U10211281	1
140	U10211282	1

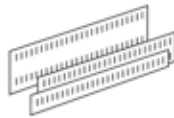

## RMD 200 FRL

### Longitudinal dividers

- For RMD 200 FRP  
- Length 555 mm

H mm	code	
50	U10211262	1
90	U10211263	1
120	U10211264	1

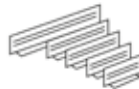

## RMD 200 FRD1

### Dividers

- For RMD 200 FRP  
- Height 60 mm

L mm	code	
98	U10211265	1
115	U10211266	1
149	U10211267	1
166	U10211268	1
249	U10211269	1



## RMD 200 FRD2

### Dividers

- For RMD 200 FRP  
- Height 100 mm

L mm	code	
98	U10211270	1
115	U10211271	1
149	U10211272	1
166	U10211273	1
249	U10211274	1

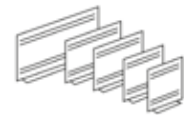

## RMD 200 FRD3

### Dividers

- For RMD 200 FRP  
- Height 140 mm

L mm	code	
98	U10211275	1
115	U10211276	1
149	U10211277	1
166	U10211278	1
249	U10211279	1

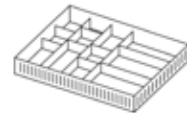

## RMD 200 FR1

### Kit dividers

- Composition: 1 200 FRP - 3 200 FRL - 6 200 FRD (L98)  
- 2 200 FRD (L249)

H mm	code	
60	U10211250	1
100	U10211251	1
140	U10211252	1

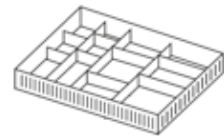

## RMD 200 FR3

### Kit dividers

- Composition: 1 200 FRP - 3 200 FRL - 2 200 FRD (L98)  
- 2 200 FRD (L115) - 4 200 FRD (L166)

H mm	code	
60	U10211256	1
140	U10211258	1



## RMD 200 FR4

### Kit dividers

- Composition: 1 200 FRP - 4 200 FRL - 4 200 FRD (L98)  
- 6 200 FRD (L115)

H mm	code	
60	U10211259	1
100	U10211260	1

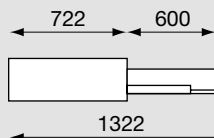

Drawer with telescopic slides for total opening loading capacity kg. 25

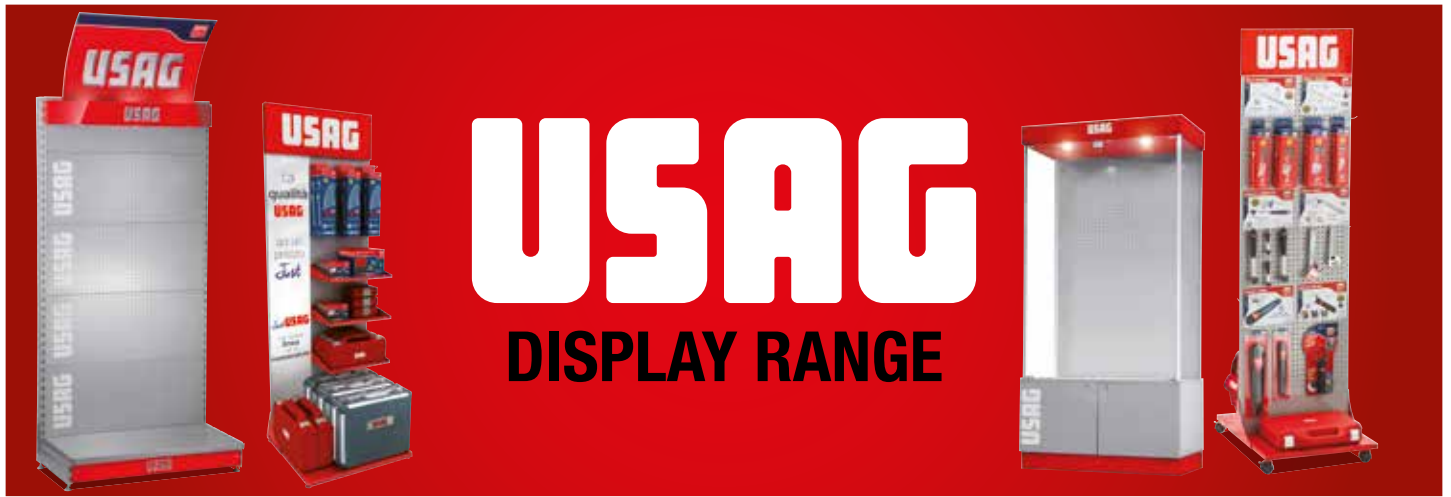

# USAG

## DISPLAY RANGE



### 6000 A

#### Display stand, initial element

- Supplied with light and USAG top
- Kit with 78 hooks and supports included
- 2 uprights included

LxPxH mm	code	
1000x500x2500	U60000010	1



### 6000 B

#### Display stand, closed corner

- Supplied with light and USAG top
- Kit with 78 hooks and supports included
- Structure without uprights

on demand

LxPxH mm	code	
1087x500x2500	U60000012	1



### 6000 D

#### Display stand, back for initial element

- Supplied with light and USAG top
- Kit with 78 hooks and supports included
- Structure without uprights

on demand

LxPxH mm	code	
1000x500x2500	U60000014	1



### 6000 AS

#### Display stand, consecutive element

- Supplied with light and USAG top
- Kit with 78 hooks and supports included
- 1 upright included

LxPxH mm	code	
1000x500x2500	U60000011	1



### 6000 C

#### Display stand, open corner

- Non-perforated panels
- Structure without uprights

on demand

LxPxH mm	code	
900(200)x500x2060	U60000013	1



### 6000 DS

#### Display stand, back for consecutive element

- Supplied with light and USAG top
- Kit with 78 hooks and supports included
- Structure without uprights

LxPxH mm	code	
1000x500x2500	U60000015	1



### 6001 A

on demand

#### Display stand, initial element

- Kit with 78 hooks and supports included
- 2 uprights included

LxPxH mm	code	
1000x500x1500	U60010010	1



### 6001 AS

on demand

#### Display stand, consecutive element

- Kit with 78 hooks and supports included
- 1 upright included

LxPxH mm	code	
1000x500x1500	U60010011	1

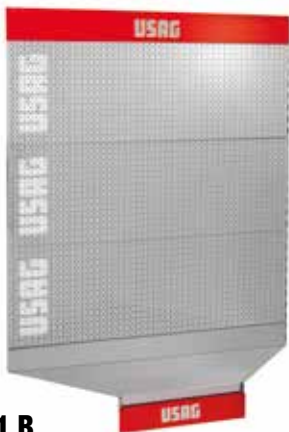

### 6001 B

on demand

#### Display stand, closed corner

- Kit with 78 hooks and supports included
- Structure without uprights

LxPxH mm	code	
1087x500x1500	U60010012	1



### 6001 C

#### Display stand, open corner

- Structure without uprights

LxPxH mm	code	
900(200)x500x1500	U60010013	1



### 6001 D

on demand

#### Display stand, back for initial element

- Kit with 78 hooks and supports included
- Structure without uprights

LxPxH mm	code	
1000x500x1500	U60010014	1



### 6001 DS

on demand

#### Display stand, back for consecutive element

- Kit with 78 hooks and supports included
- Structure without uprights

LxPxH mm	code	
1000x500x1500	U60010015	1



### 6002 TB1

#### Showcase

- Double door with lock
- Corners in Aluminium
- Internal lighting with double halogen spot-light
- Lower cabinet for stocks with double door and lock
- Built-in wheels
- Kit with 50 hooks and glass middle shelf included

LxPxH mm	code	
930x400x1830	U60025011	1

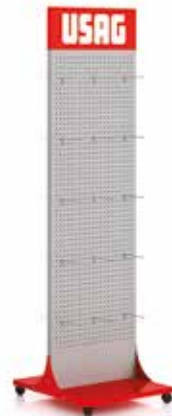

### 6002 TE

#### Display totem

- Two-faced perforated surface
- Kit with 40 hooks included
- 4 pivoting wheels

LxPxH mm	code	
625x647x1960	U60025033	1



### 545 PT

#### Perforated panel

- Hole diameter 5 mm
- Enamelled sheet steel; thickness 1,2 mm
- Combinable with screw-hooks code 552÷559
- Combinable with hooks for display stands

LxPxH mm	kg	code	
459x1,2x740	3,5	U05450001	1



### 6000 PB

on demand

#### Drawer

- To be used with linear elements 6000 and 6001

LxPxH mm	code	
986x459x100	U6000007Q	1



### 6000 E

on demand

#### Non-perforated wall 2 m height

- To be used to cover back-side of linear elements

LxH mm	code	
1000x2060	U60000016	1



### 6001 E

on demand

#### Non-perforated wall 1,5 m height

- To be used to cover back-side of linear elements

LxH mm	code	
1000x1500	U60010016	1



### 6002 A

on demand

#### Cabinet for stocks

- Wooden structure
- Supplied already assembled with base

LxPxH mm	code	
999x500x394	U60020010	1



### 6002 B1

on demand

#### High showcase

- Supplied disassembled
- Structure in Aluminium
- Glass shelves included
- Double sliding door with lock
- To be used with linear elements 6000

LxPxH mm	code	
1000x500x1504	U60020011	1



### 6002 B3

on demand

#### Small showcase

- Supplied disassembled
- Structure in Aluminium
- Glass shelves included
- Double sliding door with lock
- To be used with linear elements 6000 and 6001

LxPxH mm	code	
1000x500x1204	U60020013	1



### 6002 D

on demand

#### Sides for news

- To be put on linear elements 6000
- Highlights the exposed products
- Composed by 2 sides in red plexiglass
- Dimensions: L 200 x H 1.730 mm (thickness 3 mm)

LxPxH mm	code	
200x3x1730	U60020015	1



### 6002 DA

on demand

#### Coat hanger bar

- To be put on linear elements

dimensions (mm)	code	
995x355	U60020016	1



### 6002 EA

on demand

#### Linear shelf

- Supplied with supports for hanging
- To be used with linear elements 6000 and 6001

dimensions (mm)	code	
1000x500	U60020021	1



### 6002 EB

on demand

#### Closed corner shelf

- Supplied with supports for hanging
- To be used with closed corner elements 6000 B and 6001 B

dimensions (mm)	code	
1087x350	U60020022	1



### 6002 EC

on demand

#### Open corner shelf

- Supplied with supports for hanging
- To be used with open corner elements 6000 C and 6001 C

dimensions (mm)	code	
510x350	U60020023	1



### 6002 EGV

#### Universal shelf for 70 screwdrivers

- Suitable for display walls and totems
- RAL 9006 painted metal sheet
- 70 seats for adapters 571 B
- Supplied with 2 magnetic hooks
- Included 7 cardboard front plates

LxPxH mm	code	
480x330x100	U60025035Q	1



NEW

### 6002 RP

#### Shelf

LxPxH mm	code	
480x330x100	U60025037Q	1



### 6002 FB1

#### Separators kit

- For bases and shelves
- To be used with linear shelves 6002 EA

LxPxH mm	code	
1000x500x80	U60020027	1



### 6002 FB2

on demand

#### Separator

- For bases and shelves
- To be used with linear shelves 6002 EA

dimensions (mm)	code	
500x80	U60020028	1



### 6002 H1

#### Shelf for sockets (empty)

- Plexiglass cover to prevent shoplifting
- Lock with key
- 42 movable dividers included
- To be used with linear elements 6000 and 6001

LxPxH mm	code	
1000x400x150	U60020055	1

1/2

### 6002 H1A



#### Shelf with sockets (214 pz)

pcs	description	item/size
75	Hexagonal sockets / 8 (5 pz)-9 (5 pz)-10 (15 pz)-11 (10 pz)- 12 (10 pz)-13 (15 pz)-14 (10 pz)-15 (10 pz)- 16 (10 pz)-17 (15 pz)-18 (5 pz)-19 (10 pz)- 20 (5 pz)-21 (10 pz)-22 (10 pz)-23 (5 pz)- 24 (10 pz)-25 (5 pz)-26 (5 pz)-27 (10 pz)- 28 (5 pz)-30 (5 pz)-32 (5 pz)	235 1/2 EN
10	Extensions/125(5 pz)-250(5pz)	236 1/2
5	T-handle with sliding square drive	240 1/2 N
4	Universal joint	241 1/2

LxPxH mm	code	
1000x400x150	U05770013	1



### 6002 PA

on demand

#### Platform for roller cabinets, small

- Supplied with 6 adjustable legs

LxPxH mm	code	
1100x800x133	U60020071	1

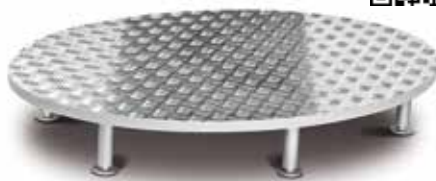

### 6002 PB

on demand

#### Platform for roller cabinets, large

- Supplied with 6 adjustable legs

LxPxH mm	code	
1800x1200x133	U60020072	1



### 6002 MA

on demand

#### Counter display stand

- Rear side with double door
- Double locking

LxPxH mm	code	
1200x600x970	U60020061	1



### 6002 MB

on demand

#### Counter display stand with front glass

- Rear side with double door
- Double locking

LxPxH mm	code	
1200x610x970	U60020062	1



### 6002 MC

on demand

#### Counter display stand with front and upper glass

- Rear side with double door
- Double locking

LxPxH mm	code	
1200x610x970	U60020063	1



### 6002 MPA

#### Magnetic tags for 1/2" impact wrenches

code	
U60025025	1



## 571 G

### Simple hooks

Ø mm	L mm	code	
3,5	100	U05710301	10
3,5	150	U05710302	10
4	100	U05710303	10
4,8	150	U05710304	10
4,8	200	U05710305	10



## 571 GA

### Double hooks

Ø mm	L mm	code	
12	100	U05710311	5
12	160	U05710312	5
20	140	U05710313	5
20	200	U05710314	5



## 571 GB

### Special hooks for pliers

Ø mm	code	
60	U05710321	5
60	U05710322	5
65	U05710323	5
65	U05710324	5



## 571 GC

### Ring double hooks

Ø mm	L mm	code	
20	250	U05710333	5



## 6002 GD

### Supports for open-jaw double ended wrenches

Ø mm	dimensions (mm)	code	
10 (6÷14 mm)	143x50	U60020047	1
10 (12÷23 mm)	143x50	U60020048	1
5 (17÷36 mm)	143x50	U60020049	1



## 6002 GM

### Magnetic support for display walls

- Applicable on all display walls with a powerful magnet
- Cardboard seat with Plexiglas protection, A5 format
- To highlight the main advantages of the best products on display

code	
U60025034	1



## 6002 GMC

### Kit of 8 cards for magnetic support

- To be inserted in the magnetic support 6002 GM
- Each card illustrates the main advantages of the best products on display
- Two-sided printing in Italian and English
- A5 format

code	
U60025040	1



## 571 FK50

### Product tag

code	
U05710453	1



## 571 GP

### Display hook for pneumatic tools (empty)

- Metal
- Applicable to linear walls or display totems with wheels
- Plexiglass card holder, 10x10 cm (tags not included)
- Supplied with quick coupler 934 C 1/4", quick nippler 935 E 1/4" and anti-shoplifting screw
- Can be used only with airtools with 1/4" air connection
- Spare cards: code U60025027Q

code	
U60025024	1



## 571 KIT

### Transformation kit for airtool display stand

- To transform your display stand with the pneumatic kit
- Suitable for wall display stands or totem
- Consisting of: advertising top, 10 display hooks 571 GP, 26 technical cards 571 CD Italian/English and 3 magnetic tags dedicated to impact tools 943 PC1 1/2", 929 PC1 1/2" and 928 AC1 1/2"

code	
U60025030	1



## 571 CD

### Kit of 26 cards for pneumatic tools

- To be used with 571 GP display hook
- Tag size: 10x10 cm
- Double face Italian/English
- Technical description for the following pneumatic tools: 913 PB2 3/8", 913 PC2 1/2", 916 B2, 916 C2, 918 B, 923 A, 920 AN1, 920 AN2, 921 A 100, 921 A 125, 921 B1, 922 B1, 922 B2, 922 BL1, 922 BP1, 922 BR1, 910 B1 3/8", 928 AC1 1/2", 928 C1 1/2", 928 PC1 1/2", 929 PC1 1/2", 942 PC1 1/2", 942 PC2 1/2", 942 PC3 1/2", 943 PC1 1/2", 943 PC2 1/2"

code	
U60025027	1





# USAG DISPLAY RANGE



## PALLBOX WITH SET OF SCREWDRIVERS



**1000 V**

**091 PB14**    

**Pallbox with sets of screwdrivers**

- Supplied with 10 set of screwdrivers 091 SH5 and 10 sets of screwdrivers 091 D/SH5

LxPxH mm	code	
345x345x1145	U00910130	1

**322 SH5/PB30**  

**Pallbox with sets of screwdrivers**

- Supplied with 30 sets of screwdrivers 322 SH5

LxPxH mm	code	
370x370x980	U03220333	1

**322 SH7/PB16**  

**Pallbox with sets of screwdrivers**

- Supplied with 30 sets of screwdrivers 322 SH7

LxPxH mm	code	
430x370x1130	U03220330	1

**322 SH10/PB16**   

**Pallbox with sets of screwdrivers**

- Supplied with 30 sets of screwdrivers 322 SH10

LxPxH mm	code	
430x370x1130	U03220331	1

**322 STX7/PB16** 

**Pallbox with sets of screwdrivers**

- Supplied with 30 sets of screwdrivers 322 STX/S7

LxPxH mm	code	
430x370x1130	U03220332	1

**324 SH8/PB20**  

**Pallbox with sets of screwdrivers**

- Supplied with 20 sets of screwdrivers 324 SH8

LxPxH mm	code	
430x370x1130	U03240600	1

**324 SH12/PB20**   

**Pallbox with sets of screwdrivers**

- Supplied with 20 sets of screwdrivers 324 SH12

LxPxH mm	code	
430x370x1130	U03240601	1

**324 STX7/PB10** 

**Pallbox with sets of screwdrivers**

- Supplied with 20 sets of screwdrivers 324 STX/S7

LxPxH mm	code	
430x370x1130	U03240602	1

## UNIVERSAL PALLBOX



**007 MV/PB30**

**Pallbox with tool-holding pouches**

- Supplied with 30 tool-holding pouches 007 MV

LxPxH mm	code	
370x370x980	U00070135	1

**207 C/PB50** 

**Pallbox with scissors**

- Supplied with 50 scissors 207 C

LxPxH mm	code	
370x370x980	U02070104	1

**210 C/PB30** 

**Pallbox with scissors**

- Supplied with 30 scissors 210 C

LxPxH mm	code	
370x370x980	U02100103	1

**211 A/PB30** 

**Pallbox with scissors**

- Supplied with 30 scissors 211 A

LxPxH mm	code	
370x370x980	U02110101	1

**220 B1/PB100**

**Pallbox with utility knives**

- Supplied with 100 utility knives 220 B1

LxPxH mm	code	
370x370x980	U02200101	1

**280 LTS/S9PB30** 

**Pallbox with sets of long hexagon keys with spherical head**

- Supplied with 30 sets of long hexagon keys with spherical head 280 LTS/S9

LxPxH mm	code	
370x370x980	U02800484	1

**280 S8/PB30** 

**Pallbox with sets of hexagon keys**

- Supplied with 30 sets of hexagon keys 280 S8

LxPxH mm	code	
370x370x980	U02800492	1

**280 S9/PB40** 

**Pallbox with sets of hexagon keys**

- Supplied with 40 sets of angled hexagon keys 280 S9

LxPxH mm	code	
370x370x980	U02800387	1

## COUNTER DISPLAYS STANDS IN CARDBOARD



### 133 AX/B5

#### Counter display stand with pliers

- Supplied with 5 half-round extra-long nose pliers with straight jaws (Chrome plated) 133 AX 160

LxPxH mm	code	
95x235x240	U01330250	1

### 133 AX/B5L

#### Counter display stand with pliers

- Supplied with 5 half-round extra-long nose pliers with straight jaws (Chrome plated) 133 AX 200



LxPxH mm	code	
95x235x240	U01330251	1



NEW

### 133 DX/B5

#### Counter display stand with pliers

- Supplied with 5 pliers 133 DX 160

LxPxH mm	code	
95x235x240	U01330256	1

### 133 DX/B5L

#### Counter display stand with pliers

- Supplied with 5 pliers 133 DX 200

NEW



LxPxH mm	code	
95x235x240	U01330257	1



### 150 AX/B5

#### Counter display stand with pliers

- Supplied with 5 combination pliers (Chrome plated) 150 AX 180

LxPxH mm	code	
95x235x240	U01500251	1

### 150 AX/B5L

#### Counter display stand with pliers

- Supplied with 5 combination pliers (Chrome plated) 150 AX 200



LxPxH mm	code	
95x235x240	U01500252	1



### 150 AX/B10

#### Counter display stand with pliers

- Supplied with 10 combination pliers (Chrome plated) 150 AX 180

LxPxH mm	code	
205x205x315	U01501151	1



NEW

### 150 DX/B5

#### Counter display

- Supplied with 5 pliers 150 DX 180

LxPxH mm	code	
95x235x240	U01500259	1

### 150 DX/B5L

#### Counter display

- Supplied with 5 pliers 150 DX 200

NEW



LxPxH mm	code	
95x235x240	U01500264	1



NEW

### 150 DX/B10

#### Counter display

- Supplied with 10 pliers 150 DX 180

LxPxH mm	code	
205x250x315	U01500358	1



### 155 AX/B5

#### Counter display

- Supplied with 5 pliers 155 AX

LxPxH mm	code	
95x235x240	U01550253	1



### 174 CX/B5

#### Counter display

- Supplied with 5 plier wrenches 174 CX

LxPxH mm	code	
95x235x240	U01740101	1



### 178 N/B5

#### Counter display stand with pliers

- Supplied with 5 lay-on slip-joint adjustable pliers 178 N 250

LxPxH mm	code	
95x235x240	U01780013	1



### 180 C/B5

#### Counter display stand with pliers

- Supplied with 5 box-joint adjustable pliers 180 C 250

LxPxH mm	code	
95x235x240	U01800013	1



### 185 AX/B5

#### Counter display stand with cutting nippers

- Supplied with 5 diagonal cutting nippers (Chrome plated) 185 AX 160

LxPxH mm	code	
95x235x240	U01850252	1



NEW

### 185 DX/B5

#### Counter display

- Supplied with 5 nippers 185 CX 160

LxPxH mm	code	
95x235x240	U01850260	1



### 188 AX/B5

#### Counter display stand with cutting nippers

- Supplied with 5 heavy-duty diagonal cutting nippers (Chrome plated) 188 AX 160

LxPxH mm	code	
95x235x240	U01880251	1



NEW

### 188 DX/B5

#### Counter display

- Supplied with 5 nippers 188 CX 160

LxPxH mm	code	
95x235x240	U01850261	1



### 207 C/B10

#### Counter display stand with scissors

- Supplied with 10 scissors 207 C

LxPxH mm	code	
205x250x315	U02070014	1



### 207 D/B6

#### Counter display stand with scissors

- Supplied with 6 scissors 207 D

LxPxH mm	code	
205x250x315	U02070108	1



### 207 E/B6

#### Counter display stand with scissors

- Supplied with 6 scissors 207 E

LxPxH mm	code	
205x250x315	U02070106	1



### 220 A1/B20

#### Counter display stand with utility knives

- Supplied with 20 utility knives 220 A1

LxPxH mm	code	
205x250x315	U02200013	1



### 220 B1/B20

#### Counter display stand with utility knives

- Supplied with 20 utility knives 220 B1

LxPxH mm	code	
205x250x315	U02200014	1



### 235 1/2 MBC10/B4

#### Counter display stand with assortments of sockets

- Supplied with 4 assortments of sockets 235 1/2 MBC10

LxPxH mm	code	
205x250x315	U02351530	1



1/2

### 270 CC3/B4

#### Counter display

- Supplied with 4 assortments of sockets 270 C/C3

LxPxH mm	code	
205x250x315	U02700107	1



### 280 LTS/B5

#### Counter display stand with hexagon keys

- Supplied with 5 sets of long angled hexagon keys with spherical head 280 LTS/S9

LxPxH mm	code	
205x250x315	U02800384	1



### 280 NS9/B5

#### Counter display stand with hexagon keys

- Supplied with 5 sets of angled hexagon keys 280 N/S9

LxPxH mm	code	
205x250x315	U02800831	1



### 283 SE5/B8

#### Counter display

- Supplied with 8 sets with double ended offset bihexagonal ring wrenches 283 SE5

LxPxH mm	code	
205x250x315	U02831420	1



### 285 KBSE5/B8

#### Counter display

- Supplied with 8 sets of flat ratchet combination wrenches 285 KB/SE5

LxPxH mm	code	
205x250x315	U02856390	1



### 280 S9/B5

#### Counter display stand with hexagon keys

- Supplied with 5 sets of angled hexagon keys 280 S9

LxPxH mm	code	
205x250x315	U02800187	1



### 285 SE5/B8

#### Counter display

- Supplied with 8 sets of 5 combination wrenches 285 SE5

LxPxH mm	code	
205x250x315	U02850880	1



### 285 KFSE5/B8

#### Counter display

- Supplied with 8 sets of hinged jointed reversible ratchet combination wrenches 285 KF/SE5

LxPxH mm	code	
205x250x315	U02856190	1



### 280 TX/B5

#### Counter display stand with hexagon keys

- Supplied with 5 sets of keys for TORX® screws 280 TX/S8C

LxPxH mm	code	
205x250x315	U02800676	1



### 285 PSE5/B8

#### Counter display

- Supplied with 8 sets of combination wrenches 285 P/SE5

LxPxH mm	code	
205x250x315	U02850881	1



### 289 NSE5/B8

#### Counter display

- Supplied with 8 sets of double ended offset tubular box wrenches 289 N/SE5

LxPxH mm	code	
205x250x315	U02890290	1



### 280 XLTSS9/B8

#### Counter display

- Supplied with 8 sets of hexagon keys 280 XLTS/S9

LxPxH mm	code	
205x250x315	U02800385	1



### 285 KASE5/B8

#### Counter display

- Supplied with 8 sets of reversible ratchet combination wrenches 285 KA/SE5

LxPxH mm	code	
205x250x315	U02856090	1



### 291 NSE5/B8

#### Counter display

- Supplied with 8 sets with double ended hollow offset socket wrenches 289 N/SE5

LxPxH mm	code	
205x250x315	U02910290	1



### 294 AC/B5

#### Counter display stand with adjustable wrenches

- Supplied with 5 short adjustable wrenches 294 AC

LxPxH mm	code	
205x250x315	U02940110	1



### 324 SH5/B5

#### Counter display

- Supplied with 5 set of screwdrivers 324 SH5

LxPxH mm	code	
205x250x315	U03240610	1



### 333 K SH8/B8

#### Counter display

- Supplied with 8 assortments COMBIDRIVE 333 K/SH8

LxPxH mm	code	
205x250x315	U03330150	1



### 341 SH6/B5

#### Counter display stand with precision screwdrivers

- Supplied with 5 sets of precision screwdrivers 341 SH6

LxPxH mm	code	
205x250x315	U03410118	1



### 341 SH17/B5

#### Counter display stand with precision screwdrivers

- Supplied with 5 sets of precision screwdrivers with interchangeable blades 341 SH17

LxPxH mm	code	
205x250x315	U03410116	1



### 341 SH33/B5

#### Counter display stand with precision screwdrivers

- Supplied with 5 sets of bit-holder precision screwdrivers and bits 341 SH33

LxPxH mm	code	
205x250x315	U03410119	1



### 341 SH4TX/B5

#### Counter display stand with precision screwdrivers

- Supplied with 5 sets of precision screwdrivers for TORX® screws 341 SH4TX

LxPxH mm	code	
205x250x315	U03410117	1



### 458 EB9/B6

#### Counter display stand with grip bits for damaged hexagonal screws

- Supplied with 6 sets of grip bits for damaged hexagonal screws 458 EB9

LxPxH mm	code	
205x250x315	U04581313	1



### 601 J34/B4

#### Counter display stand with assortments of sockets

- Supplied with 4 assortments of sockets 601 1/4 J34

LxPxH mm	code	
205x250x315	U06010002	1



### 601 JTX16/B4

#### Counter display stand with assortments of sockets

- Supplied with 4 assortments of sockets 601 1/4-1/2 JTX16

LxPxH mm	code	
205x250x315	U06010019	1



### 692 J49/BA10

#### Counter display stand with bits and accessories

- Supplied with 10 boxes with bits and accessories 692 J49

LxPxH mm	code	
205x250x315	U06920141	1



### 889 TS/B5

#### Counter display stand with torches

- Supplied with 5 LED torches 889 TS

LxPxH mm	code	
205x250x315	U08890123	1

## METAL DISPLAY STANDS



### 085 EX/SH20

#### Multiple display hook with pliers and cutting nippers - 1000V (20 pcs.)

- Possibility to place alongside 2 display hooks on totems and up to 3 display hooks on the display stands

pcs	description	item/size
5	Half-round extra-long nose pliers with straight jaws - 1000 V	081 EX/160
5	Combination pliers - 1000 V	085 EX/180
5	Diagonal cutting nippers - 1000 V	087 EX/160
5	Heavy-duty diagonal cutting nippers - 1000 V	088 EX/160
1	Multiple display hook for pliers and cutting nippers (empty)	150 SHV

code	item/size
U00850260	1



### 091 RP1

#### Shelf with screwdrivers, for display stands - 1000V (100 pcs.)

pcs	description	item/size
50	Screwdrivers for slot-head screws - 1000 V /0,4x2,5x75 (10 pz)-0,5x3x75 (10 pz)-0,8x4x100 (10 pz)-1x5,5x125 (10 pz)-1,2x6,5x150 (10 pz)	091
30	Screwdrivers for PHILLIPS® screws - 1000 V /0x75 (10 pz)-1x100 (10 pz)-2x125 (10 pz)	091 PH
20	Screwdrivers for POZIDRIV® - SUPADRIV® screws - 1000 V /1x100 (10 pz)-2x125 (10pz)	091 PZ
100	Adapters for screwdrivers displays / M0 (10 pz)-M1 (20 pz)-M2 (40 pz)-M3 (30 pz)	571 B
1	Universal shelf for 70 screwdrivers	6002 EGV

LxPxH mm	code	item/size
480x330x100	U00910200	1



### 1000 V

#### 091 RP2

#### Shelf with screwdrivers, for display stands - 1000V (100 pcs.)

pcs	description	item/size
100	Screwdrivers for slot-head screws - 1000 V /0,4x2,5x50 (10 pz)-0,4x2,5x75 (10 pz)-0,5x3x75 (10 pz)-0,5x3x100 (10 pz)-0,6x3,5x75 (10 pz)-0,6x3,5x	091
100	Adapters for screwdrivers displays/M0 (20 pz)-M1 (40 pz)-M2 (20 pz)-M3 (10 pz)-M4 (10 pz)	571 B
1	Universal shelf for 70 screwdrivers	6002 EGV

LxPxH mm	code	item/size
480x330x100	U00910201	1



### 1000 V

#### 091 RP3

#### Shelf with screwdrivers, for display stands - 1000V (100 pcs.)

pcs	description	item/size
10	SLIM screwdrivers for combined shape for slot-head and PHILLIPS® screws - 1000 V /2x125	091 DPHB
10	SLIM screwdrivers for combined shape for slot-head/POZIDRIV®-SUPADRIV® screws - 1000 V/2x125	091 DPZB
40	Screwdrivers for PHILLIPS® screws - 1000 V /0x75 (10 pz)-1x100 (10 pz)-2x125 (10 pz)-3x150 (10 pz)	091 PH
40	Screwdrivers for POZIDRIV® - SUPADRIV® screws - 1000 V /0x75 (10 pz)-1x100 (10 pz)-2x125 (10 pz)-3x150 (10 pz)	091 PZ
100	Adapters for screwdrivers displays / M1 (20 pz)-M2 (20 pz)-M3 (40 pz)-M4 (20 pz)	571 B
1	Universal shelf for 70 screwdrivers	6002 EGV

LxPxH mm	code	item/size
480x330x100	U00910202	1



### 1000 V

#### 091 RP4

#### Shelf with screwdrivers, for display stands - 1000V (100 pcs.)

pcs	description	item/size
40	SLIM Screwdrivers for slot-head screws - 1000 V /0,6x3,5x100 (10 pz)-0,8x4x100 (10 pz)-1x5,5x125 (10 pz)-1,2x6,5x150 (10 pz)	091 D
20	SLIM screwdrivers for PHILLIPS® screws - 1000 V /1x100 (10 pz)-2x125 (10 pz)	091 DPH
20	SLIM screwdrivers for combined shape for slot-head and PHILLIPS® screws - 1000 V /1x100 (10 pz)-2x125 (10 pz)	091 DPHB
20	SLIM screwdrivers for combined shape for slot-head/POZIDRIV®-SUPADRIV® screws - 1000 V/1x100 (10 pz)-2x125 (10 pz)	091 DPZB
100	Adapters for screwdrivers displays / M1 (10 pz)-M2 (50 pz)-M3 (40 pz)	571 B

LxPxH mm	code	item/size
480x330x100	U00910203	1



### 1000 V

#### 091 RPB1

#### Counter display stand with screwdrivers 1000 V

pcs	description	item/size
50	Screwdrivers for slot-head screws - 1000 V /0,4x2,5x75 (10 pz)-0,5x3x75 (10 pz)-0,8x4x100 (10 pz)-1x5,5x125 (10 pz)-1,2x6,5x150 (10 pz)	091
30	Screwdrivers for PHILLIPS® screws - 1000 V /0x75 (10 pz)-1x100 (10 pz)-2x125 (10 pz)	091 PH
20	Screwdrivers for POZIDRIV® - SUPADRIV® screws - 1000 V /1x100 (10 pz)-2x125 (10pz)	091 PZ
100	Adapters for screwdrivers displays /M0 (10 pz)-M1 (20 pz)-M2 (40 pz)-M3 (30 pz)	571 B

LxPxH mm	code	item/size
480x330x250	U00910210	1



### 127 C/SH20

#### Multiple display hook with circlips pliers (20 pcs.)

pcs	description	item/size
5	Pliers with straight nose for internal circlips	127 C/19=60
5	Pliers with nose bent at 90° for internal circlips	127 CP/19=60
5	Pliers with straight nose for external circlips	128 C/19=60
5	Pliers with nose bent at 90° for external circlips	128 CP/19=60
1	Multiple display hook for pliers and cutting nippers (empty)	150 SHV

code	item/size
U01270042	1



### 127 N/SH20

#### Multiple display hook with circlips pliers (20 pcs.)

pcs	description	item/size
5	Pliers with straight nose for internal circlips	127 N/19=60
5	Pliers with nose bent at 90° for internal circlips	127 PN/19=60
5	Pliers with straight nose for external circlips	128 N/19=60
5	Pliers with nose bent at 90° for external circlips	128 PN/19=60
1	Multiple display hook for pliers and cutting nippers (empty)	150 SHV

code	item/size
U01270041	1



### 134 A/B8

#### Counter display stand with grip pliers

pcs	description	item/size
2	Lock-grip pliers with concave jaws	134 A/250
2	Lock-grip rack-type pliers with short jaws	135 A/250
2	Lock-grip rack-type pliers with long jaws	135 B/250
2	Lock-grip rack-type pliers with high capacity	135 C/250
1	Counter display stand for grip pliers (empty)	134 ASV

LxPxH mm	code	img
260x153x360	U01340010	1

### 134 ASV

#### Counter display stand for grip pliers (empty)

- Painted metal structure

code	img
U01340010Q	1



### 178 N/SH20

#### Multiple display hook with adjustable pliers (20 pcs.)

pcs	description	item/size
5	Lay-on slip-joint adjustable pliers	178 N/250
5	Semiautomatic adjustable pliers	180 B/250
5	Long nose semiautomatic adjustable pliers	180 BL/250
5	Box-joint adjustable pliers	180 C/250
1	Multiple display hook for pliers and cutting nippers (empty)	150 SHV

code	img
U01780260	1

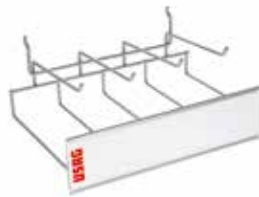

### 150 SHV

#### Multiple display hook for pliers and cutting nippers (empty)

- Possibility to place alongside 2 display hooks on totems and up to 3 display hooks on the display stands

code	img
U01500260Q	1

### 150 AX/SH20

#### Multiple display hook with pliers and cutting nippers (20 pcs.)

- Possibility to place alongside 2 display hooks on totems and up to 3 display hooks on the display stands

pcs	description	item/size
5	Half-round extra-long nose pliers with straight jaws	133 AX/160
5	Combination pliers	150 AX/180
5	Diagonal cutting nippers	185 AX/160
5	Heavy-duty diagonal cutting nippers	188 AX/160
1	Multiple display hook for pliers and cutting nippers (empty)	150 SHV

code	img
U01500260	1



### 298 RP1

#### Shelf with hexagonal socket spinners for display stands (100 pcs.)

pcs	description	item/size
100	Hexagonal socket spinners with grip / 5-5,5-6-7-8-9-10-11-12-13	298
1	Universal shelf for 70 screwdrivers	6002 EGV

LxPxH mm	code	img
480x330x100	U02980200	1



### 299 RP1

#### Shelf with hexagonal socket spinners, for display stands (100 pcs.)

pcs	description	item/size
100	Hexagonal socket spinners with grip / 4-5-5,5-6-7-8-9-10-11-13	299
1	Universal shelf for 70 screwdrivers	6002 EGV

LxPxH mm	code	img
480x330x100	U02990300	1



### 324 RP1

#### Shelf with screwdrivers, for display stands (100 pcs.)

pcs	description	item/size
40	Screwdrivers for slot-head screws / 0,5x3x75 (10 pz)-0,8x4x100 (10 pz)-1x5,5x125 (10 pz)-1,2x6,5x150 (10 pz)	324
10	Screwdrivers for slot-head screws / 0,4x2,5x50	324 D
10	Screwdrivers for slot-head screws / 0,8x4x35	324 N
10	Screwdrivers for PHILLIPS® screws	324 NPH/2x35
30	Screwdrivers for PHILLIPS® screws / 0x75 (10 pz)-1x75 (10 pz)-2x100 (10 pz)	324 PH
100	Adapters for screwdrivers displays/M0 (20 pz)-M1 (30 pz)-M2 (20 pz)-M3 (30 pz)	571 B
1	Universal shelf for 70 screwdrivers	6002 EGV

LxPxH mm	code	img
480x330x100	U03240620	1



### 324 RP2

#### Shelf with screwdrivers, for display stands (100 pcs.)

pcs	description	item/size
50	Screwdrivers for slot-head screws/ 0,4x2,5x50 (10 pz)-0,5x3x75 (10 pz)-0,8x4x100 (10 pz)-1x5,5x125 (10 pz)-1,2x6,5x150 (10 pz)	324
30	Screwdrivers for PHILLIPS® screws / 0x75 (10 pz)-1x75 (10 pz)-2x100 (10 pz)	324 PH
20	Screwdrivers for POZIDRIV®-SUPADRIV® screws/1x75-2x100	324 PZ
100	Adapters for screwdrivers displays /M0 (20 pz)-M1 (20 pz)-M2 (30 pz)-M3 (30 pz)	571 B
1	Universal shelf for 70 screwdrivers	6002 EGV

LxPxH mm	code	img
480x330x100	U03240621	1



### 324 RP3

Shelf with screwdrivers, for display stands (100 pcs.)

pcs	description	item/size
50	Screwdrivers for slot-head screws /0,5x3x75-0,8x4x100-1x5,5x125-1,2x6,5x150-1,2x8x200-1,6x10x200	324
20	Screwdrivers for slot-head screws / 0,4x2,5x50-0,6x3,5x100	324 D
10	Screwdrivers for slot-head screws / 1x5,5x35	324 N
100	Adapters for screwdrivers displays/ M0 (20 pz)-M1 (30 pz)-M2 (20 pz)-M3 (10 pz)-M4 (20 pz)	571 B
1	Universal shelf for 70 screwdrivers	6002 EGV

LxPxH mm	code	1
480x330x100	U03240622	1

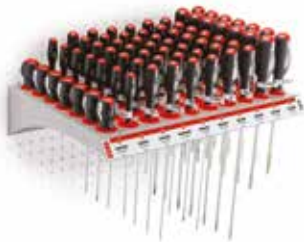

### 324 RP4

Shelf with screwdrivers, for display stands (100 pcs.)

pcs	description	item/size
30	Screwdrivers for slot-head screws /0,5x3x100-0,8x4x125-1x5,5x100	324
10	Screwdrivers for slot-head screws/0,4x2x75	324 D
20	Screwdrivers for slot-head screws / 1,6x10x175-2x12x250	324 E
30	Screwdrivers for slot-head screws / 0,6x3,5x250-0,8x4x300-1x5,5x300	324 L
10	Screwdrivers for slot-head screws/1,2x6,5x35	324 N
100	Adapters for screwdrivers displays / M0 (20 pz)-M1 (30 pz)-M2 (20 pz)-M3 (10 pz)-M4 (20 pz)	571 B
1	Universal shelf for 70 screwdrivers	6002 EGV

LxPxH mm	code	1
480x330x100	U03240623	1

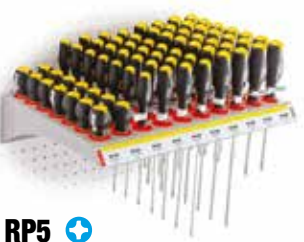

### 324 RP5

Shelf with screwdrivers, for display stands (100 pcs.)

pcs	description	item/size
20	Screwdrivers for PHILLIPS® screws / 1x250-2x250	324 LPH
20	Screwdrivers for PHILLIPS® screws / 1x35-2x35	324 NPH
60	Screwdrivers for PHILLIPS® screws / 0x75-1x75-1x100-2x100-3x15-4x200	324 PH
100	Adapters for screwdrivers displays /M1 (10 pz)-M2 (40 pz)-M3 (30 pz)-M4 (20 pz)	571 B
1	Universal shelf for 70 screwdrivers	6002 EGV

LxPxH mm	code	1
480x330x100	U03240624	1

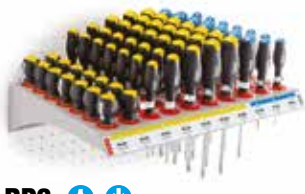

### 324 RP6

Shelf with screwdrivers, for display stands (100 pcs.)

pcs	description	item/size
20	Screwdrivers for PHILLIPS® screws / 1x35-2x35	324 NPH
50	Screwdrivers for PHILLIPS® screws / 0x75-1x75-2x100-3x150-4x200	324 PH
30	Screwdrivers for POZIDRIV®-SUPADRIV® screws/0x75-1x75-2x100	324 PZ
100	Adapters for screwdrivers displays /M1 (20 pz)-M2 (30 pz)-M3 (30 pz)-M4 (20 pz)	571 B
1	Universal shelf for 70 screwdrivers	6002 EGV

LxPxH mm	code	1
480x330x100	U03240625	1



### 324 RP7

Shelf with screwdrivers, for display stands (100 pcs.)

pcs	description	item/size
100	Screwdrivers for TORX® screws /T6x50-T7x50-T8x50-T9x50-T10x75-T15x75-T20x100-T25x100-T27x100-T30x125	324 TX
100	Adapters for screwdrivers displays /M0 (40 pz)-M1 (10 pz)-M2 (10 pz)-M3 (40 pz)	571 B
1	Universal shelf for 70 screwdrivers	6002 EGV

LxPxH mm	code	1
480x330x100	U03240626	1



### 324 RP8

Shelf with screwdrivers, for display stands (100 pcs.)

pcs	description	item/size
60	Screwdrivers for TORX® Tamper Resistant screws /TT10x75-TT15x75-TT20x100-TT25x100-TT27x100-TT30x125	324 STX
40	Screwdrivers for TORX® screws / T6x50-T7x50-T8x50-T9x75	324 TX
100	Adapters for screwdrivers displays /M0 (40 pz)-M1 (10 pz)-M2 (10 pz)-M3 (40 pz)	571 B
1	Universal shelf for 70 screwdrivers	6002 EGV

LxPxH mm	code	1
480x330x100	U03240627	1



### 324 RPB2

Counter display stand with screwdrivers (100 pz)

pcs	description	item/size
50	Screwdrivers for slot-head screws /0,4x2,5x50 (10 pz)-0,5x3x75 (10 pz)-0,8x4x100 (10 pz)-1x5,5x125 (10 pz)-1,2x6,5x150 (10 pz)	324
30	Screwdrivers for PHILLIPS® screws / 0x75 (10 pz)-1x75 (10 pz)-2x100 (10 pz)	324 PH
20	Screwdrivers for POZIDRIV®-SUPADRIV® screws/1x75-2x100	324 PZ
100	Adapters for screwdrivers displays /M0 (20 pz)-M1 (20 pz)-M2 (30 pz)-M3 (30 pz)	571 B

LxPxH mm	code	1
480x330x250	U03240631	1



### 324 RPB7

Counter display stand with screwdrivers (100 pz)

pcs	description	item/size
100	Screwdrivers for TORX® screws /T6x50-T7x50-T8x50-T9x50-T10x75-T15x75-T20x100-T25x100-T27x100-T30x125	324 TX
100	Adapters for screwdrivers displays /M0 (40 pz)-M1 (10 pz)-M2 (10 pz)-M3 (40 pz)	571 B

LxPxH mm	code	1
480x330x250	U03240636	1



### 571 B

Adapters for screwdrivers displays

- 5 adapters that correspond to the handles of the whole range of USAG screwdrivers
- Same external diameter, can be freely positioned on the 6002 EGV metal shelf

M	Ø outside mm	code	10
0	34	U05710001	10
1	34	U05710002	10
2	34	U05710003	10
3	34	U05710004	10
4	34	U05710005	10





## 6002 EGV

### Universal shelf for 70 screwdrivers

- Suitable for display walls and totems
- RAL 9006 painted metal sheet
- 70 seats for adapters 571 B
- Supplied with 2 magnetic hooks
- Included 7 cardboard front plates

LxPxH mm	code	
480x330x100	U60025035Q	1



## 6002 EGB

### Lift for display stands (2 pcs)

LxPxH mm	code	
480x330x250	U60025038Q	1



## 922 B3/S5

### Counter display stand with grinders

- Supplied with 5 connections

pcs	description	item/size
1	Straight die grinder - 0,4 CV (300W)	921 B1
1	Straight grinder - 0.3 CV (220 W)	922 B1
1	Straight grinder - 0.5 CV (368 W)	922 B2
1	Long anvil straight grinder - 0.3 CV (220 W)	922 BL1
1	90° Angle grinder - 0.3 CV (220 W)	922 BP1

LxPxH mm	code	
430x350x100	U09220101	1



## 928 A1/S3

### Counter display stand with impact wrenches

- Supplied with 5 connections

pcs	description	item/size
1	Aluminium impact wrench	928 AC1 1/2
1	Magnesium impact wrench	929 PC1 1/2
1	Magnesium impact wrench with LED - the top	943 PC1 1/2
1	Counter display stand (empty)	928 ASV

LxPxH mm	code	
430x350x100	U09280103	1

## 928 ASV

### Counter display stand (empty)

- Supplied with 5 connections



LxPxH mm	code	
430x350x100	U09280001Q	1



## 943 PC1/S1

### Counter display for impact wrench

- Texts in Italian language

pcs	description	item/size
1	Magnesium impact wrench with LED - the top	943 PC1 1/2
1	Counter display for impact wrench (empty)	943 PC1/S1V

LxPxH mm	code	
400x236x370	U60025017	1

## 943 PC1/S1V

### Counter display for impact wrench (empty)



LxPxH mm	code	
400x236x370	U60025023	1



**NEW**



## 007 T29

### Soft storage display

- Composed by 29 bags, totem display and shelves

pcs	description	item/size
2	Professional tool bag	007/1V
2	Professional tool bag	007 V
2	Trolley tool bag	007 TXV
1	Folding tool bag	007 FBV
1	Folding tool bag	007 FTSV
4	Tool-holding pouch	007 MV
2	Tool-holding pouch with belt	007 MLV
4	Organizer	007 ORV
4	Laptop bag	007 PCV
3	Bag for laptop and tools	007 RV
2	Professional backpack	007 SV
2	Professional tool trolley	007 TV

code	
U00070100	1

## 5 adapters that correspond to the handles of the whole range of USAG screwdrivers

SCREWDRIVER CODE	ITEM	ADAPTER CODE
U00910003	091 0.4x2.5x50	M0 U05710001
U00910004	091 0.4x2.5x75	M0 U05710001
U00910005	091 0.5x3x75	M1 U05710002
U00910006	091 0.5x3x100	M1 U05710002
U00910007	091 0.6x3.5x75	M1 U05710002
U00910008	091 0.6x3.5x100	M1 U05710002
U00910009	091 0.8x4x100	M2 U05710003
U00910010	091 0.8x4x150	M2 U05710003
U00910011	091 1x5.5x125	M2 U05710003
U00910012	091 1x5.5x150	M2 U05710003
U00910013	091 1.2x6.5x150	M3 U05710004
U00910014	091 1.2x8x150	M4 U05710005
U00910015	091 1.6x10x200	M4 U05710005
U00910023	091 PH 0x75	M1 U05710002
U00910025	091 PH 1x100	M2 U05710003
U00910027	091 PH 2x125	M3 U05710004
U00910029	091 PH 3x150	M4 U05710005
U00910031	091 PH 4x200	M4 U05710005
U00910040	091 PZ 0x75	M1 U05710002
U00910042	091 PZ 1x100	M2 U05710003
U00910044	091 PZ 2x125	M3 U05710004
U00910046	091 PZ 3x150	M4 U05710005
U00910067	091 D 0.6x3.5x100	M1 U05710002
U00910068	091 D 0.8x4x100	M2 U05710003
U00910070	091 D 1x5.5x125	M2 U05710003
U00910072	091 D 1.2x6.5x150	M3 U05710004
U00910085	091 DPH 1x100	M2 U05710003
U00910087	091 DPH 2x125	M3 U05710004
U00910094	091 DPHB 1x100	M2 U05710003
U00910095	091 DPHB 2x125	M3 U05710004
U00910098	091 DPZB 1x100	M2 U05710003
U00910099	091 DPZB 2x125	M3 U05710004
U02430201	243 C 1/4	M2 U05710003
U02430211	243 1/4 SN	M4 U05710005
U02800821	280 D 1.5	M0 U05710001
U02800822	280 D 2	M0 U05710001
U02800823	280 D 2.5	M0 U05710001
U02800824	280 D 3	M0 U05710001
U02800826	280 D 4	M1 U05710002
U02800828	280 D 5	M2 U05710003
U02800830	280 D 6	M3 U05710004
U02800859	280 TS 2	M0 U05710001
U02800860	280 TS 2.5	M0 U05710001
U02800861	280 TS 3	M0 U05710001
U02800863	280 TS 4	M1 U05710002
U02800865	280 TS 5	M2 U05710003
U02800867	280 TS 6	M3 U05710004
U02980251	298 4	M3 U05710004
U02980252	298 5	M3 U05710004
U02980253	298 5.5	M3 U05710004
U02980254	298 6	M3 U05710004
U02980255	298 7	M3 U05710004
U02980256	298 8	M3 U05710004

SCREWDRIVER CODE	ITEM	ADAPTER CODE
U02980257	298 9	M3 U05710004
U02980258	298 10	M4 U05710005
U02980259	298 11	M4 U05710005
U02980260	298 12	M4 U05710005
U02980261	298 13	M4 U05710005
U02980292	298 SN 5.5	M4 U05710005
U02980293	298 SN 6	M4 U05710005
U02980294	298 SN 7	M4 U05710005
U02980295	298 SN 8	M4 U05710005
U02980297	298 SN 10	M4 U05710005
U02980299	298 SN 13	M4 U05710005
U02990201	299 4	M3 U05710004
U02990202	299 5	M3 U05710004
U02990203	299 5.5	M3 U05710004
U02990204	299 6	M3 U05710004
U02990205	299 7	M3 U05710004
U02990206	299 8	M3 U05710004
U02990207	299 9	M3 U05710004
U02990208	299 10	M4 U05710005
U02990209	299 11	M4 U05710005
U02990210	299 12	M4 U05710005
U02990211	299 13	M4 U05710005
U02990212	299 14	M4 U05710005
U03240401	324 0.5x3x75	M0 U05710001
U03240402	324 0.5x3x100	M0 U05710001
U03240403	324 0.8x4x100	M1 U05710002
U03240404	324 0.8x4x125	M1 U05710002
U03240405	324 0.8x4x150	M1 U05710002
U03240406	324 1x5.5x100	M2 U05710003
U03240407	324 1x5.5x125	M2 U05710003
U03240408	324 1x5.5x150	M2 U05710003
U03240409	324 1.2x6.5x125	M3 U05710004
U03240410	324 1.2x6.5x150	M3 U05710004
U03240411	324 1.2x8x200	M4 U05710005
U03240412	324 1.6x10x200	M4 U05710005
U03240413	324 2x12x250	M4 U05710005
U03240419	324 L 0.6x3.5x250	M1 U05710002
U03240420	324 L 0.8x4x300	M1 U05710002
U03240421	324 L 1x5.5x300	M2 U05710003
U03240425	324 D 0.4x2x75	M0 U05710001
U03240426	324 D 0.4x2.5x50	M0 U05710001
U03240427	324 D 0.5x3x75	M0 U05710001
U03240428	324 D 0.6x3.5x100	M1 U05710002
U03240429	324 D 0.8x4x100	M1 U05710002
U03240430	324 D 0.8x4x150	M1 U05710002
U03240431	324 D 1x5.5x125	M2 U05710003
U03240432	324 D 1x5.5x150	M2 U05710003
U03240433	324 D 1.2x6.5x150	M3 U05710004
U03240439	324 PH 0x75	M1 U05710002
U03240440	324 PH 1x75	M2 U05710003
U03240441	324 PH 1x100	M2 U05710003
U03240442	324 PH 2x100	M3 U05710004
U03240443	324 PH 2x125	M3 U05710004



SCREWDRIVER CODE	ITEM	ADAPTER CODE
U03240444	324 PH 3x150	M4
U03240445	324 PH 4x200	M4
U03240450	324 LPH 1x250	M2
U03240451	324 LPH 2x250	M3
U03240452	324 LPH 2X400	M3
U03240456	324 PZ 0x75	M1
U03240457	324 PZ 1x75	M2
U03240458	324 PZ 2x100	M3
U03240459	324 PZ 3x150	M4
U03240471	324 TX T6x50	M0
U03240472	324 TX T7x50	M0
U03240473	324 TX T8x50	M0
U03240474	324 TX T9x75	M0
U03240475	324 TX T10x75	M1
U03240476	324 TX T15x75	M2
U03240477	324 TX T20x100	M3
U03240478	324 TX T25x100	M3
U03240479	324 TX T27x100	M3
U03240480	324 TX T30x125	M3
U03240481	324 TX T40x150	M4
U03240486	324 STX T10x75	M1
U03240487	324 STX T15x75	M2
U03240488	324 STX T20x100	M3
U03240489	324 STX T25x100	M3
U03240490	324 STX T27x100	M3
U03240491	324 STX T30x125	M3
U03240492	324 STX T40x150	M4
U03240495	324 LTX T20x275	M3
U03240496	324 LTX T25x275	M3
U03240497	324 LTX T27x275	M3
U03240498	324 LTX T30x275	M3
U03240499	324 LTX T40x275	M4
U03240505	324 E 1x5.5x125	M2
U03240506	324 E 1.2x6.5x150	M3
U03240507	324 E 1.2x8x175	M4
U03240508	324 E 1.6x8x175	M4
U03240509	324 E 1.6x10x175	M4
U03240510	324 E 2x12x250	M4
U03240513	324 EPH 1x100	M2
U03240514	324 EPH 2x125	M3
U03240515	324 EPH 3x150	M4
U03240516	324 EPH 4x200	M4
U03240520	324 EPZ 2x125	M3
U03240521	324 EPZ 3x150	M4
U03240522	324 EPZ 4x200	M4
U03240533	324 H 0.8x4x100	M1
U03240534	324 H 1x5.5x125	M2
U03240535	324 H 1.2x6.5x150	M3
U03240536	324 H 1.2x8x175	M4
U03240537	324 H 1.6x10x175	M4
U03240538	324 H 2x12x200	M4
U03240539	324 H 2.5x14x250	M4
U03240541	324 HPH 1x100	M2

SCREWDRIVER CODE	ITEM	ADAPTER CODE
U03240542	324 HPH 2x125	M3
U03240543	324 HPH 3x150	M4
U03240463	324 N 0.8x4x35	M0
U03240464	324 N 1x5.5x35	M1
U03240465	324 N 1.2x6.5x35	M2
U03240468	324 NPH 1x35	M0
U03240469	324 NPH 2x35	M2
U06900102	690 A 1/4 180	M3
U06900103	690 A 1/4 245	M3
U03220025	322 0.4x2x50	M1
U03220005	322 0.4x2.5x75	M1
U03220006	322 0.5x3x75	M1
U03220007	322 0.6x3.5x100	M1
U03220028	322 0.6x3.5x75	M2
U03220008	322 0.8x4x100	M2
U03220009	322 0.8x4x125	M3
U03220011	322 1x5.5x100	M2
U03220012	322 1x5.5x125	M3
U03220014	322 1.2x6.5x125	M4
U03220015	322 1.2x6.5x150	M4
U03220017	322 1.6x8x175	M4
U03220023	322 1.6x10x200	M4
U03220024	322 2x12x250	M4
U03220039	322 PH 0x75	M2
U03220041	322 PH 1x100	M3
U03220043	322 PH 2x125	M3
U03220047	322 PH 3x150	M4
U03220056	322 PZ 0x75	M2
U03220057	322 PZ 1x100	M3
U03220058	322 PZ 2x125	M3
U03220063	322 N 0.8x4x30	M0
U03220064	322 N 1x5.5x30	M1
U03220065	322 N 1.2x6.5x30	M2
U03220068	322 NPH 1x30	M0
U03220069	322 NPH 2x30	M2
U03220071	322 TX T6x50	M1
U03220072	322 TX T7x50	M1
U03220073	322 TX T8x50	M1
U03220074	322 TX T9x75	M1
U03220075	322 TX T10x75	M2
U03220076	322 TX T15x75	M2
U03220077	322 TX T20x100	M2
U03220078	322 TX T25x100	M3
U03220079	322 TX T27x100	M3
U03220080	322 TX T30x125	M4
U03220081	322 TX T40x125	M4
U03220086	322 STX T10x75	M2
U03220087	322 STX T15x75	M2
U03220088	322 STX T20x100	M2
U03220089	322 STX T25x100	M2
U03220090	322 STX T27x100	M2
U03220091	322 STX T30x125	M2
U03220092	322 STX T40x125	M2



# USAG *Griffe*



NEW

## 3700 A

### Red/blue apron

- Strong fabric: 65% polyester, 35% cotton

Size	code	
M	U37000004G	1
L	U37000005G	1
XL	U37000006G	1
XXL	U37000007G	1



NEW

## 3704 A

### Red/blue dungaree

- Strong fabric: 65% polyester, 35% cotton  
- Padded knees

Size	code	
M	U37040004G	1
L	U37040005G	1
XL	U37040006G	1
XXL	U37040007G	1



## 3706 C

### Working bermuda

- Fabric: 65% polyester, 35% cotton  
- 2 side pockets  
- Back with elastic  
- Waistband with belt loops  
- 2 front pockets + one back pocket with flap and Velcro

Size	code	
S	U37060024G	1
M	U37060025G	1
L	U37060026G	1
XL	U37060027G	1
XXL	U37060028G	1



NEW

## 3702 A

### Red/blue working overall

- Strong fabric: 65% polyester, 35% cotton  
- Padded knees and elbows

Size	code	
M	U37020004G	1
L	U37020005G	1
XL	U37020006G	1
XXL	U37020007G	1



## 3706 B

### Trousers

- Fabric: 65% polyester, 35% cotton  
- 2 wide side pockets  
- Rear side with elastic  
- Belt with loops  
- Two front pockets and 1 rear pocket with flap and Velcro

Size	code	
S	U37060014G	1
M	U37060015G	1
L	U37060016G	1
XL	U37060017G	1
XXL	U37060018G	1



## 3706 D

### Work jeans

- 6-pocket jeans, suitable for every season  
- Stretch fabric 96% cotton - 4% lycra  
- Color: dark blue

Size	code	
S	U37060034G	1
M	U37060035G	1
L	U37060036G	1
XL	U37060037G	1
XXL	U37060038G	1

## 3706 F

### Work jeans, female model

- 6-pocket jeans, suitable for every season  
- Stretch fabric 96% cotton - 4% lycra  
- Colour: dark blue

Size	code	
S	U37060054G	1
M	U37060055G	1
L	U37060056G	1



### 3706 E

#### Short work jeans

- 6-pocket jeans, suitable for every season
- Stretch fabric 96% cotton - 4% lycra
- Color: dark blue

Size	code	
S	U37060044G	1
M	U37060045G	1
L	U37060046G	1
XL	U37060047G	1
XXL	U37060048G	1



### 3708 B

#### Extreme Softshell jacket

- Ergonomic jacket for man with long waterproof zip SBS
- Adjustable cuffs
- 2 side pockets with zip
- Chest pocket with badge holder
- Pocket on the left arm
- Material: softshell (8000mm / 5000 mvp)

Size	code	
M	U37080014G	1
L	U37080015G	1
XL	U37080016G	1
XXL	U37080017G	1



### 3708 D

#### Padded jacket

- Technical breathable anti-tear and water-resistant fabric
- Detachable sleeves
- Featherweight polyester padding
- Color: Blue Navy
- 4 External pockets (two with zip and two with flap)
- Adjustable cuffs with elastic and velcro strap
- Retractable hood

Size	code	
S	U37080043G	1
M	U37080044G	1
L	U37080045G	1
XL	U37080046G	1
XXL	U37080047G	1



### 3708 E

#### K-Way jacket

- 100% soft polyester fabric with mesh lining
- Two pockets with zip
- Colour: dark blue

Size	code	
XS	U37080052G	1
S	U37080053G	1
M	U37080054G	1
L	U37080055G	1
XL	U37080056G	1
XXL	U37080057G	1



### 3710 B

#### Vest

- Technical breathable anti-tear and water-resistant fabric
- Red micropile lining
- Color: Blue Navy
- 4 External pockets (two with zip and two with flap)

Size	code	
S	U37100013G	1
M	U37100014G	1
L	U37100015G	1
XL	U37100016G	1
XXL	U37100017G	1



### 3712 A

#### Vintage hoodie, male model

- Hoodie with lined hood
- Pouch pocket
- Slim fit
- Unbrushed fabric 80% combed cotton - 20% polyester peso 300 g
- Dark grey color

Size	code	
M	U37120044G	1
L	U37120045G	1
XL	U37120046G	1



### 3712 B

#### Hoodie, male model

- 80% combed cotton - 20% polyester
- Double fabric hood with internal jersey
- Zip nylon, invisible
- 2 welt pockets

Size	code	
S	U37120014G	1
M	U37120015G	1
L	U37120016G	1
XL	U37120017G	1
XXL	U37120018G	1

### 3712 C

#### Hoodie, female model

- 80% combed cotton - 20% polyester
- Double fabric hood with internal jersey
- Nylon zip, invisible
- 2 welt pockets

Size	code	
S	U37120034G	1
M	U37120035G	1
L	U37120036G	1



### 3714 A

#### Shirt with short sleeves

- 100% combed cotton
- Button-down collar

Size	code	
S	U37140013G	1
M	U37140014G	1
L	U37140015G	1
XL	U37140016G	1
XXL	U37140017G	1



### 3716 A

#### Shirt with long sleeves

- 100% combed cotton
- Button-down collar

Size	code	
S	U37160013G	1
M	U37160014G	1
L	U37160015G	1
XL	U37160016G	1
XXL	U37160017G	1



NEW

### 3718 A

#### T-shirt vintage - short sleeve

- Slim fit
- Material: fabric in 100% medium weight combed cotton
- Dark grey

Size	code	
M	U37180044G	1
L	U37180045G	1
XL	U37180046G	1



### 3718 B

#### T-shirt, short sleeves

- T-shirt, round neck
- 100% combed cotton

Size	code	
S	U37180013G	1
M	U37180014G	1
L	U37180015G	1
XL	U37180016G	1
XXL	U37180017G	1



### 3720 B

#### Polo, short sleeves, male model

- 100% combed cotton piquet

Size	code	
S	U37200013G	1
M	U37200014G	1
L	U37200015G	1
XL	U37200016G	1
XXL	U37200017G	1

### 3720 C

#### Polo shirt, female model

- 100% combed cotton piquet

Size	code	
S	U37200033G	1
M	U37200034G	1
L	U37200035G	1



### 3725 A

#### Long graduated compression socks

- 4 seasons socks with 3D graduated compression structure
- This particular process fights the force of gravity, reduces muscle vibrations and helps the return of venous blood to the heart
- Particularly suitable for those who stand all day
- Protections inserted in the areas of greatest friction
- Yarn composition:  
65% X- Dry hollow fiber polypropylene (PP)  
19% X- Pro polyamide consisting of linear macromolecules (PA)  
16% Elastane

Size	code	
39-42	U37250001G	1
43-46	U37250002G	1



### 3730 B

#### Cap

- Fabric: polyester jacquard
- Blue color
- Single size with loop and adjustable strap with Velcro

code	
U37300010G	1



### 3730 C

#### Winter beanie

- Acrylic fabric
- Single size

code	
U37300020G	1



### 3731 A

#### Tubular neck warmer

- 100% polyester bi-material
- Anti-pilling micro-fleece + microfiber

LxH mm	code	
220x760	U37310001G	1



### 3760 B

#### Waist bag

- Nylon 420 D
- External pocket
- Interna pocket

LxPxH mm	code	
270x180x70	U37600010G	1



### 3760 D

#### Free time backpack

- Resistant fabric
- Internal pocket for laptop 15.6"
- External pocket
- Rain cover
- Capacity: 10 liters

LxPxH mm	code	
300x100x410	U37600030G	1



### 3760 E

#### Multi-pocket backpack

- Resistant fabric
- Polyester 420D, Nylon 420D
- 2 external pockets
- 1 internal pocket
- Rain cover
- Capacity 25 liters
- Dimensions 48x31x14 cm

code	
U37300032G	1



### 3760 F

#### Sport bag

- Nylon 420 D
- Side pocket
- Inner pocket
- Padded shoulder strap

LxPxH mm	code	
320x320x550	U37600040G	1



### 3761 A

#### USAG trolley

- ABS 20"
- 4 PMS wheels
- 1 zipped pocket inside

LxPxH mm	kg	code	
450x250x560	2	U38000071	1



### 3770 A

#### Chronograph

- Analogic
- Quartz movement
- Stainless steel case
- Water resistant 5 ATM
- Leather strap

code	
U3770001G	1



### 3770 C

#### Watch

- Analogic with quartz movement
- Metal case
- Water resistant 5 ATM
- Black rubber strap

code	
U3770007G	1



### 3774 B

#### Pen

- With pocket clip

code	
U37740010G	1



### 3775 A

#### Keyring

- PVC body
- Metal hook

code	
U3775001G	1



### 3775 B

#### Lanyard

- Band in synthetic fabric with safety device anti-strangling
- Metal releasable buckle
- Spring catch for keys/badge
- Hook for phone/memory key

code	
U37750005G	1



### 3776 A

#### USAG block notes

- Size: 15x21 cm
- Squared paper

code	
U37760001G	50



### 3776 C

#### Organizer

- Block of 20 lined sheets
- Pen not included

LxPxH mm	code	
245x315x15	U37760012G	1



### 3777 A

#### Mouse pad

- Dimensions: 23x19 cm

code	
U37770001G	1



### 3777 B

#### Wireless optical mouse

- Suitable for devices with USB port
- Bluetooth technology
- 2 buttons and scroll wheel
- 2 batteries 1.5 V - AAA (not included)

LxPxH mm	code	
110x60x20	U37770010G	1



### 3777 C

#### Memory stick USB 237 B

- Capacity: 4GB

code	
U37770020G	1



### 3777 F

#### USB Power Bank

- Metal and ABS body
- For any device with a USB port
- Autonomy: 9 hours
- Rechargeable on a PC
- DC input: 5.0V / 1.0A
- DC output: 5.0V / 1.5 V
- Capacity: 5200 mAh

code	
U37770042G	1



### 3777 H

#### Thermal bottle 500 ml

- Double-wall stainless steel

Ø mm	H mm	code	
7,5	22,5	U37770050G	1



### 3778 A

#### Bracelet

- In PVC

code	
U37780001G	1



### 3779 A

#### Umbrella

- Metal structure
- Wooden handle
- 130 cm diameter

code	
U37790001G	1



### 3779 B

#### Foldable umbrella

- Excellent stormproof system for use even in case of strong wind
- Automatic opening and closing
- Soft-touch bicolour handle with raised push button
- Diameter: 118 cm

code	
U37790002G	1



### 3780 A

#### Paper shopping bag

- In paper kraft 170 gr
- Cotton handle 45 mm
- Reinforced bottom
- Dimensions: 36x12x45 cm

code	
U37800001G	1



### 3780 B

#### Bag

- Nonwoven fabric
- Logo USAG on one side
- Dimensions: 38x10x42 cm

code	
U37800010G	1



### 3781 B

#### Fender cover

- PVC and flock
- Magnetic
- Dimensions: 115x70 cm

code	
U37810005G	10





NEW

### 3781 F

#### Doormat

- Rubber non-slip 100% polyamide fiber
- Washable in a washing machine at 30°

LxH mm	g	code	
1000x850	600	U37810025G	1



### 3782 B

#### Steel knife

- Stainless steel
- Safety device to prevent accidental closure
- Supplied in metal box

code	
U37820005G	1



### 3783 A

#### Leaflet holder

- In cardboard
- For documents A4 format
- Dimensions: 26x35 cm

code	
U37830001G	1



### 3783 B

#### Wall clock

- Analogic with quartz movement (battery not included)
- Thermometer and hygrometer integrated
- Dial and plastic case with safety glass
- Diameter 22,5 cm
- Thickness 4,1 cm

code	
U37830005G	1



### 3783 D

#### USAG sticker - horizontal

Dimensions cm	code	
10x2,6	U37830101G	1
20x5,2	U37830100G	1
50x13,2	U37830102G	1



### 3785 A

#### Banner

- Banner in PVC, single side, with boss on sides for easy fixing
- Indoor/outdoor use

Dimensions cm	code	
200x65	U37850001G	1
400x100	U37850002G	1
600x125	U37850003G	1



### 3785 B

#### Flag

- Outdoor model: strong fabric resistant to atmospheric conditions
- Dimensions: 120x80 cm
- Complete with side hooks to anchorage at pennon

code	
U37850010G	1



### 3785 D

#### Indoor lighting

- One-side
- Support in anodised Aluminum profiles, silver, 120 mm thick
- Front in methacrylate opal
- Graphics in translucent adhesive
- Electrical system composed of LED modules with 150° lens, integrated current stabilizer (totally encapsulated), white color temperature 6000/6500 K
- CE compliant
- Supplied in wooden box

LxH mm	code	
1000x300	U37850020G	1



### 3785 E

#### Outdoor lighting

- One-side
- Support in anodised aluminum profiles, silver, 120 mm thick
- Front in methacrylate opal
- Graphics in translucent adhesive
- Electrical system composed of LED modules with 150° lens, integrated current stabilizer (totally encapsulated), white color temperature 6000/6500 K
- CE compliant
- Supplied in wooden box

LxH mm	code	
1000x1000	U37850025G	1



### 3785 C

#### Flag - sail type

- Telescopic shaft with base to fix at ground
- Height 190 cm
- Can be stored in a fabric bag 100x25 cm

code	
U37850015G	1

## CONDITIONS GENERALES DE VENTE STANLEY BLACK & DECKER ITALIA SRL (EXPORTATION)

### 1. NORMES APPLICABLES

- 1.1 Les commandes sont acceptées par **Stanley Black & Decker Italia SRL** (par la suite "le Vendeur") aux conditions spécifiées ci-après qui sont considérées acceptées par l'Acheteur avec le placement de la commande. D'éventuelles dérogations à ces conditions générales ne seront valables que si elles auront été convenues par écrit entre les parties. Tous les contrats de vente entre les parties ainsi que ces Conditions Générales seront régies par la loi italienne et en particulier par la Convention des Nations Unies sur les contrats internationaux de vente de marchandises (signée à Vienne le 11 avril 1980. Le texte en langue italienne des présentes Conditions Générales est le seul faisant foi.
- 1.2 Toute référence à des termes commerciaux (par ex. EXW, FOB, CIF etc.) sera interprétée comme une référence aux Incoterms de la Chambre de Commerce Internationale, dans le texte en vigueur à la date de conclusion du contrat de vente.

### 2. CARACTÉRISTIQUES DES PRODUITS

- 2.1 Les poids, dimensions, prix, couleurs et autres données figurant dans les catalogues, prospectus, circulaires ou autres documents illustratifs du Vendeur ne constituent que des indications approximatives.
- 2.2 Le Vendeur se réserve de modifier à tout moment, sans préavis, les données techniques et constructives de ses Produits.

### 3. COMMANDES - RELIQUATS - CONDITIONNEMENT ET EMBALLAGE

- 3.1 Sauf ce qui est indiqué à la clause 4.1, les commandes sont irrévocables pour l'Acheteur. Le Vendeur a la faculté d'accepter la commande en expédiant les marchandises, conformément à l'article 1327 du code civil italien.
- 3.2 Le Vendeur pourra exécuter la commande partiellement ou à plusieurs reprises. Dans le cas d'exécution partielle de la commande le Vendeur attachera une liste mise à jour des Produits reliquats qui remplacera toute liste précédente. Les Produits non envoyés seront inclus, dans la mesure des disponibilités, dans la livraison suivante.
- 3.3 La commande devra spécifier le code de l'article et les quantités respectives, sans indication des prix, rabais et conditions de paiement (spécifier seulement "Conditions en vigueur").
- 3.4 Les quantités devront être conformes, pour chaque article et mesure, en respectant les conditionnements standard du Vendeur, comme indiqué dans la colonne correspondante de la liste de prix du Vendeur. Le Vendeur se réserve le droit d'exécuter la commande conformément à ses conditionnements standard même lorsque ces conditionnements ne se conforment pas à la commande. Des emballages particuliers seront facturés au coût. Si l'acheteur souhaite commander des quantités différentes de celles du conditionnement proposé, les frais de service sont imputés à un taux forfaitaire de 6% à la facturation.

### 4. DÉLAIS DE LIVRAISON

- 4.1 Les délais de livraison éventuellement convenus entre les parties sont calculés en jours ouvrables. Ils sont purement indicatifs et ne lient par conséquent pas le Vendeur. Toutefois en présence d'un retard imputable au Vendeur excédant les 120 jours, l'Acheteur pourra résilier le contrat de vente pour les Produits dont la livraison est retardée avec un préavis de 20 jours qui devra être communiqué au Vendeur par écrit (aussi par téléphone).
- 4.2 N'est pas considéré imputable au Vendeur le retard éventuel dû à force majeure ou résultant d'agissements ou d'omissions imputables à l'Acheteur.
- 4.3 Sauf fraude ou faute lourde du Vendeur, toute prétention de l'Acheteur au titre de préjudice résultant d'une absence de fourniture ou d'une fourniture tardive est expressément exclue.

### 5. LIVRAISON ET TRANSPORT – RÉSERVE DE PROPRIÉTÉ

- 5.1 Sauf convention contraire, la livraison sera présumée être faite Ex-Works (EXW), même s'il est convenu que le transport doit être opéré totalement ou partiellement par le Vendeur. La livraison aura lieu à tous effets auprès de l'établissement du Vendeur lorsque les Produits sont chargés sur le moyen de transport du premier transporteur.
- 5.2 Le risque passera à l'Acheteur au plus tard lorsque le Vendeur remet les Produits au premier transporteur.

### 6. RÉCLAMATIONS

- 6.1 Toute réclamation concernant l'état de l'emballage, les quantités ou les caractéristiques extérieures des Produits (vices apparents) devra être notifiée au Vendeur, par écrit, dans les 15 jours suivant la date de réception des Produits; à défaut d'une telle notification l'Acheteur ne pourra invoquer ce type de défaut. En outre, s'il apparaît que les marchandises ou les emballages sont endommagés ou en cas des Produits manquants, l'Acheteur devra formuler envers le transporteur les réserves appropriées selon les formes prévues pour le moyen de transport utilisé.
- 6.2 Toute réclamation relative à des défauts ne pouvant pas être reconnus au terme d'une inspection diligente au moment de la réception (vices cachés) devra être notifiée au Vendeur, par écrit, dans les 15 jours suivant la constatation du défaut et en tout état de cause, dans les douze mois suivant la livraison. En l'absence d'une telle notification l'Acheteur ne pourra invoquer le défaut en question. La réclamation devra spécifier avec précision le défaut et les Produits auxquels il se réfère.
- 6.3 Il est convenu que toute réclamation ou plainte émise par l'Acheteur ne saurait lui permettre de suspendre ou de retarder le paiement des Produits objet de la contestation de même que le paiement de toute autre fourniture. En outre l'Acheteur ne pourra pas effectuer aucune restitution des Produits sans accord préalable des parties.

### 7. GARANTIES

- 7.1 Le Vendeur s'engage à remédier à toute non conformité (vice) des Produits dont il serait responsable et qui apparaîtrait dans les douze mois après leur livraison, sous condition que celle-ci lui ait été notifiée en temps utile conformément à l'article 6. Dans ce cas le Vendeur remplacera ou réparera, à son choix, les Produits résultant d'un défaut. Cette garantie ne s'applique pas aux Produits présentant une usure normale ou des signes d'altération ou d'usage impropre. Cette garantie ne concerne pas les produits de consommation, c'est à dire les produits (ou parts de produits) sujets à usure ou bien qui s'endommagent pour effet du normal emploi comme, par exemple, garnitures, roulements, lames de scie, piles et batteries. Les frais de transport des Produits à remplacer ou à réparer, et des Produits remplacés ou réparés, sont à la charge de l'Acheteur.
- 7.2 Sauf fraude ou faute lourde du Vendeur, la seule obligation du Vendeur en cas de non conformité (vices) des Produits sera de réparer ou de remplacer les Produits défectueux. Il est convenu que les garanties ci-dessus (c'est-à-dire de réparer ou de remplacer les Produits) excluent toute autre obligation à titre de la garantie ou responsabilité légale ainsi que toute autre responsabilité (soit contractuelle qu'extracontractuelle) du Vendeur qui pourrait être mise en jeu par le fait des Produits livrés (par exemple réparation du préjudice, perte de profit, etc.).
- 7.3 L'Acheteur accepte d'assumer en voie exclusive la responsabilité pour toute obligation découlant d'éventuelles actions (directes ou en voie de grèges) engagée par des acheteurs successifs, basée sur les articles 1519-bis et suivants du code civil italien (ou sur des dispositions analogues d'autres Etats membres de l'Union Européenne, en application de la directive européenne 1999/44/CE du 25 mai 1999). Par conséquent les parties conviennent d'exclure tout droit de grèges envers le Vendeur basé sur l'art. 1519-quinquies du code civil italien (ou sur une disposition analogue de la loi d'un autre Etat membre, basée sur la directive 1999/44/CE) par l'Acheteur qui aurait remédié à une non conformité envers le consommateur (ou qui aurait subi le grèges d'un vendeur successif pour la même raison). En outre l'Acheteur s'engage à tenir le Vendeur indemne contre toute action de grèges qui pourrait être intentée contre lui par d'éventuels acheteurs successifs de l'Acheteur.

### 8. PRIX

- 8.1 Sauf convention contraire, les prix sont ceux indiqués sur le Tarif officiel du Vendeur et sont considérés Ex-Works, avec l'emballage normal. Ces prix peuvent être modifiés à tout moment par le Vendeur.
- 8.2 Les prix sont au net de la TVA et d'éventuelles taxes ou impôts, droits ou charges fiscales de tout genre qui pourraient s'appliquer au contrat.

### 9. CONDITIONS DE PAIEMENT

- 9.1 Le paiement doit être fait exclusivement au Vendeur aux conditions convenues.
- 9.2 Remises pour paiements à réception facture doivent être calculées sur le montant net de la marchandise, sauf emballage, frais postaux ou de transport et TVA. Après 15 jours de la date de facture ou du délai établi par les parties la remise conditionnée sera révoquée et le paiement devra être effectué sur le montant total de la facture.
- 9.3 En cas de retard de paiement par rapport à la date convenue, l'Acheteur devra payer au Vendeur des intérêts de retard correspondant au taux d'intérêt de la principale facilité de refinancement de la Banque centrale européenne majoré de sept points, conformément à l'article 4 du décret n. 231 du 9 octobre 2002 qui donne application à la directive européenne CE 35/2000. Si le retard dépasse les 30 jours suivant la date de paiement indiquée dans la facture, le Vendeur aura le droit de résilier le contrat, de retenir la partie du prix payée et de prétendre la restitution, aux soins et dépenses de l'Acheteur, des Produits fournis, outre la réparation d'éventuels dommages.
- 9.4 L'Acheteur est autorisé à effectuer aucune déduction du prix convenu (par ex. en cas de prétendus défauts des Produits), sauf en cas d'accord écrit préalable avec le Vendeur.
- 9.5 Au cas où le Vendeur aurait des raisons de redouter que l'Acheteur ne puisse pas ou n'ait pas l'intention de payer à la date convenue, il pourra subordonner la livraison à l'octroi de garanties de paiement appropriées (par exemple sûreté ou garantie bancaire). En outre, le Vendeur pourra, en cas de retards de paiement, modifier unilatéralement les termes d'autres fournitures et/ou en suspendre l'exécution jusqu'à l'obtention de garanties de paiement appropriées.

### 10. JURIDICTION COMPÉTENTE

Les tribunaux de Milan seront exclusivement compétents pour trancher tout différend survenant du fait ou en rapport avec ce contrat. Cependant, par exception, le Vendeur est habilité, en tout état de cause, à agir devant des juridictions compétentes du siège de l'Acheteur.

## CONDICIONES GENERALES DE VENTA STANLEY BLACK & DECKER ITALIA SRL (EXPORTACIÓN)

### 1. NORMATIVA CONTRACTUAL

- 1.1 **Stanley Black & Decker Italia SRL**, de aquí en adelante llamado "el vendedor", asumirá los pedidos en las condiciones abajo especificadas, las que se encuentran aceptadas por el comprador desde el momento de la entrega del pedido. Eventuales excepciones a lo antedicho sólo tendrán valor cuando las partes las hayan acordado por escrito. Todos los contratos de venta entre las partes como así también las presentes Condiciones Generales se regirán por la ley italiana y, en particular, por la Convención de las Naciones Unidas sobre Contratos de Venta Internacional de Mercaderías, suscrita en Viena el 11 de abril de 1980. Para todos los efectos legales derivados del presente contrato hará fe única y exclusivamente el texto en lengua italiana de las presentes Condiciones Generales.
- 1.2 Cualquier referencia a eventuales términos comerciales (por ej.: Ex-fábrica, FOB, CIF, etc.) se entenderá hecha según los Incoterms de la Cámara de Comercio Internacional, considerando el texto vigente en el momento de la celebración del contrato de venta.

### 2. CARACTERÍSTICAS DE LOS PRODUCTOS

- 2.1 Los pesos, las dimensiones, los precios, los colores y los demás datos que figuren en los catálogos, folletos, circulares u otros documentos ilustrativos del vendedor, tendrán el carácter de indicaciones meramente aproximativas.
- 2.2 El vendedor se reserva la facultad de cambiar en cualquier momento y sin aviso previo, los datos técnicos o de fabricación de sus productos.

### 3. PEDIDOS, SALDOS, ENVASES Y EMBALAJES

- 3.1 Con la sola excepción contemplada en el punto 4.1, los pedidos efectuados por el comprador serán irrevocables. El vendedor podrá aceptar el pedido mediante la expedición de la mercadería, de conformidad con lo dispuesto por el art. 1327 del C.C.
- 3.2 El vendedor se reserva la facultad de despachar sólo parcialmente el pedido o mediante varios envíos parciales. En caso de expedición sólo parcial del pedido, se enviará una LISTA DE SALDO actualizada, que anulará toda eventual lista precedente. Los productos incluidos en la lista antedicha serán despachados, dentro de los límites de disponibilidad, en la expedición sucesiva.
- 3.3 En el pedido se deberá especificar el código del artículo y la respectiva cantidad, omitiendo las indicaciones de precio, descuento y condiciones de pago (especificar sólo: "Condiciones vigentes").
- 3.4 Las cantidades relativas a cada artículo y tamaño deberán ser pedidas ateniéndose a los envases estándar del vendedor y de la forma indicada en la respectiva columna de la lista del vendedor. El Vendedor se reserva el derecho de realizar los pedidos en función de sus envases estándares aunque estos envases no correspondan a el pedido. Los embalajes especiales serán facturados al costo. Si un comprador desea solicitar cantidades distintas a las suministradas en las unidades de embalaje, por este servicio se aplica una tarifa fija del 6 % sobre el importe de la factura.

### 4. PLAZOS DE ENTREGA

- 4.1 Los plazos de entrega eventualmente concertados por las partes se contarán considerando sólo los días de trabajo. Dichos plazos tendrán un carácter meramente ilustrativo y, por lo tanto, no serán obligatorios para el vendedor. Sin embargo, en caso de retrasos imputables al vendedor que superen los 120 días, el comprador podrá revocar el contrato de venta -sólo respecto de los productos cuya entrega haya sufrido retraso- mediante un pre-aviso de veinte días que deberá enviar por escrito al vendedor (incluido mediante fax).
- 4.2 No será imputable al vendedor el eventual retraso debido a fuerza mayor o a actos u omisiones del comprador.
- 4.3 Salvo en caso de dolo o culpa grave del vendedor, queda expresamente excluido del presente contrato cualquier tipo de rescaramiento por daños debidos a retraso o falta de entrega de los productos.

### 5. ENTREGA Y EXPEDICIÓN. RESERVA DE PROPIEDAD

- 5.1 Salvo pacto en contrario, la entrega de los productos se entiende Ex-fábrica, aun cuando se haya acordado que la expedición o parte de ésta será de cargo del vendedor. La entrega se entenderá efectuada, para todos los efectos legales a que hubiera lugar, en el establecimiento del vendedor y al momento de efectuar la carga en el vehículo del primer transportista.
- 5.2 Los riesgos serán de cargo del comprador, a contar de la entrega de la mercadería al primer transportista.

### 6. RECLAMACIONES

- 6.1 Eventuales reclamos relativos al estado del embalaje, cantidad o características exteriores de los productos (vicios aparentes), deberán notificarse por escrito al vendedor, dentro de los 15 días siguientes a la fecha de recepción de los productos, so pena de caducidad. Además, en caso de que la mercadería o su respectivo embalaje resulten dañados o bien en caso de falta de mercadería, el comprador deberá formular las reservas del caso al transportista respetando las formas previstas para la modalidad de transporte utilizado.
- 6.2 Eventuales reclamos relativos a defectos imposibles de identificar mediante un control diligente efectuado en el momento de la recepción (vicios ocultos) deberán notificarse al vendedor, so pena de caducidad, dentro de los 15 días siguientes a la fecha en que dichos defectos hayan sido descubiertos y, en ningún caso, más allá de doce meses, contados desde la fecha de entrega. En el reclamo se deberá especificar con precisión el defecto encontrado y los productos a los cuales se refiere.
- 6.3 Se establece que eventuales reclamos o impugnaciones no facultarán al comprador para suspender o retardar el pago de los productos objeto de impugnación ni, menos aún, el pago relativo a otras entregas. Además, el comprador tampoco podrá efectuar devolución de la mercadería sin previo acuerdo de ambas partes.

### 7. GARANTÍA RELATIVA A DEFECTOS DE LOS PRODUCTOS

- 7.1 El vendedor se obliga a subsanar cualquier defecto de conformidad (vicio) de los productos que le sea imputable y que se verifique dentro del plazo de doce meses, contados desde la fecha de entrega de los productos, siempre y cuando dicho defecto se le notifique oportunamente, de conformidad con lo dispuesto por el art. 6°. En este caso, el vendedor procederá, a su elección, a la sustitución o reparación de los productos que resulten defectuosos. Dicha garantía no se aplicará a productos que presenten desgaste normal o señales de haber sido alterados ni en caso de uso impropio de los mismos. Dicha garantía no se aplicará a productos desgastados por efecto de normal empleo como, por ejemplo, guarniciones, hojas de sierra, cojinetes, pilas y baterías. Los gastos de transporte tanto de los productos que se deban sustituir o reparar como de los productos sustituidos o reparados serán de cargo del comprador.
- 7.2 Salvo el caso de dolo o culpa grave, si existiera algún defecto de conformidad (vicios) de los productos, el vendedor estará obligado sólo a la reparación o sustitución de los productos defectuosos. Se establece que esta garantía (consistente en la obligación de reparar o sustituir los productos) es extintiva y substitutiva de las garantías o responsabilidades previstas por la ley y excluye cualquier otro tipo de responsabilidad del vendedor (tanto contractual como extracontractual) que pudiera derivar de la entrega de los productos (por ej.: rescaramiento de daños, ausencia de ganancias, etc.).
- 7.3 El comprador acepta asumirse de modo exclusivo la responsabilidad por eventuales obligaciones derivadas de acciones ejercidas por vendedores sucesivos (por vía directa o por derecho de reembolso), de conformidad con lo dispuesto por el art. 1519-bis del C.C. (o por normas análogas de otro Estado miembro de la Unión Europea, basadas en la directiva europea 1999/44/CE del 25 de mayo de 1999). Por lo tanto, las partes acuerdan expresamente liberar al vendedor de cualquier eventual obligación de reembolso, de conformidad con lo establecido por el art. 1519-quinquies del C.C. (o por normas análogas de otro Estado miembro, basadas en la directiva 1999/44/CE) respecto del comprador que haya subsanado un defecto de conformidad respecto del consumidor (o al que un vendedor sucesivo le haya solicitado el reembolso por dicha razón). Además, el comprador se obliga a liberar al vendedor respecto de cualquier acción de reembolso que en contra de éste último pudieren intentar eventuales sucesivos adquirentes del comprador.

### 8. PRECIOS

- 8.1 Salvo pacto en contrario, los precios son los de la lista de precios oficial del Vendedor, se entienden Ex-fábrica, embalaje normal incluido. Dichos precios podrán ser modificados en cualquier momento por el vendedor.
- 8.2 Los precios se entienden sin IVA incluido (IVA aparte) y sin eventuales impuestos o tasas, como así también de tributos, derechos o cargas fiscales o de cualquier otra especie que eventualmente graven el contrato.

### 9. CONDICIONES DE PAGO

- 9.1 El pago deberá ser efectuado exclusivamente al vendedor, de conformidad con las condiciones convenidas.
- 9.2 Los descuentos previstos para los pagos efectuados inmediatamente después de haberse recibido la factura, serán calculados sobre el importe neto de la mercadería, excluidos el embalaje, los gastos de correo y/o transporte y el IVA. Transcurridos 15 días desde la fecha de la factura -o del período convenido en su caso- sin que se haya efectuado el pago, se entenderá caducado el beneficio del descuento condicionado y, por lo tanto, el pago deberá efectuarse por el valor total de la factura.
- 9.3 En caso de existir retraso en el pago con respecto a la fecha pactada, el comprador deberá pagar al vendedor un interés de mora equivalente a la tasa de interés del principal instrumento de refinanciación del Banco Central Europeo más el 7%, de conformidad con lo dispuesto por el art. 4° del Decreto Regl. N° 231 del 9 de octubre de 2002, aplicativo de la directiva CE 35/2000. El eventual retraso de pago que supere en la medida de 30 días la fecha indicada en la factura, facultará al vendedor para revocar el contrato, retener para sí la parte del precio que haya sido pagada y demandar la restitución por cuenta y cargo del comprador de los productos suministrados, además del rescaramiento de los eventuales daños.
- 9.4 El comprador no está autorizado para efectuar deducción alguna sobre el precio pactado (por ej.: en caso de supuestos defectos de los productos), sin previo acuerdo manifestado por el vendedor por escrito.
- 9.5 En caso de que el vendedor tenga motivos suficientes para temer que el comprador no pueda o no quiera pagar el precio de los productos en la fecha pactada, podrá subordinar la entrega de los productos al otorgamiento de adecuadas garantías de pago (por ej.: fianza o garantía bancaria). Asimismo, en caso de retrasos en el pago, el vendedor podrá modificar unilateralmente las condiciones de otros eventuales suministros y/o suspender su ejecución hasta obtener adecuadas garantías de pago.

### 10. TRIBUNAL COMPETENTE

En caso de verificarse cualquier controversia derivada de la interpretación y/o aplicación del presente contrato, será exclusivamente competente para conocer de ella el tribunal de Milán (Italia). No obstante lo anterior, el vendedor tendrá siempre la facultad de recurrir al tribunal del domicilio del comprador.

# THE COMPLETE CATALOG AT YOUR FINGERTIPS, ALWAYS UPDATED

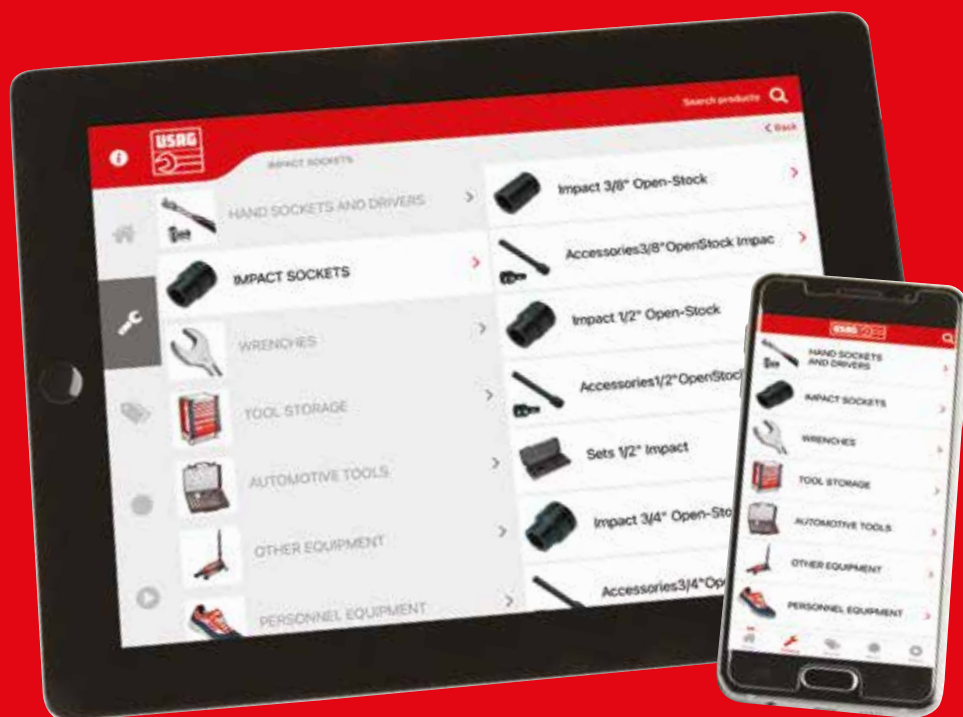

## Download the App!

- Works offline.
- Push notifications.
- Light.



## ON SMARTPHONE AND TABLET

Do you need support from us?  
Go to our website:



[usag.it/en/contacts/support](https://usag.it/en/contacts/support)



**Stanley Black & Decker Italia S.r.l.**

Via Volta, 3 - 21020 - Monvalle (VA)

Tel. +39 0332 790 111

info.mv@usag.it

[usag-tools.net](https://usag-tools.net)

